



Assembly Instructions



10x20 Booth



10x10 Booth

Alternate Configurations



10x10 Booth



# Assembly Instructions:

## Custom FabLite Display

Assemble the frames as shown below.

1) Assemble the frame by connecting the pieces with matching Letters. Each piece slides into the next piece using the spring lock to secure into place.

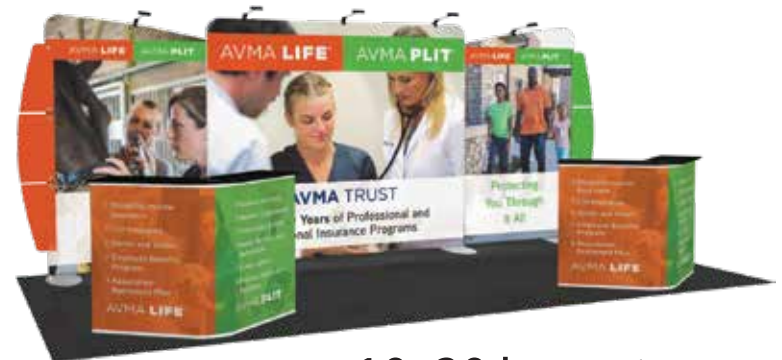
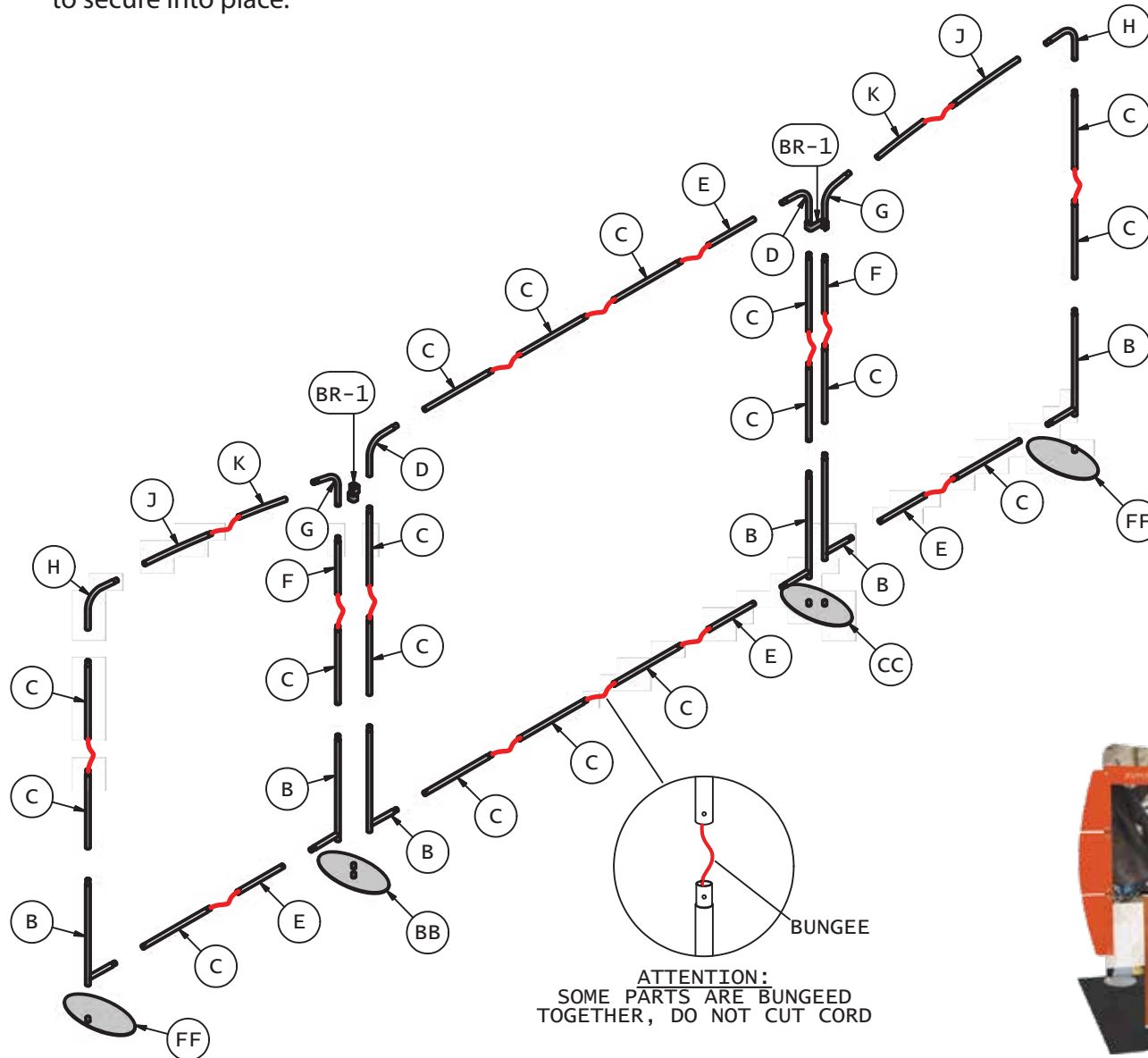

10x20 Layout

## Assembly Instructions:

## Custom FabLite Display

Assemble the frames as shown below.

1) Assemble the frame by connecting the pieces with matching Letters. Each piece slides into the next piece using the spring lock to secure into place.

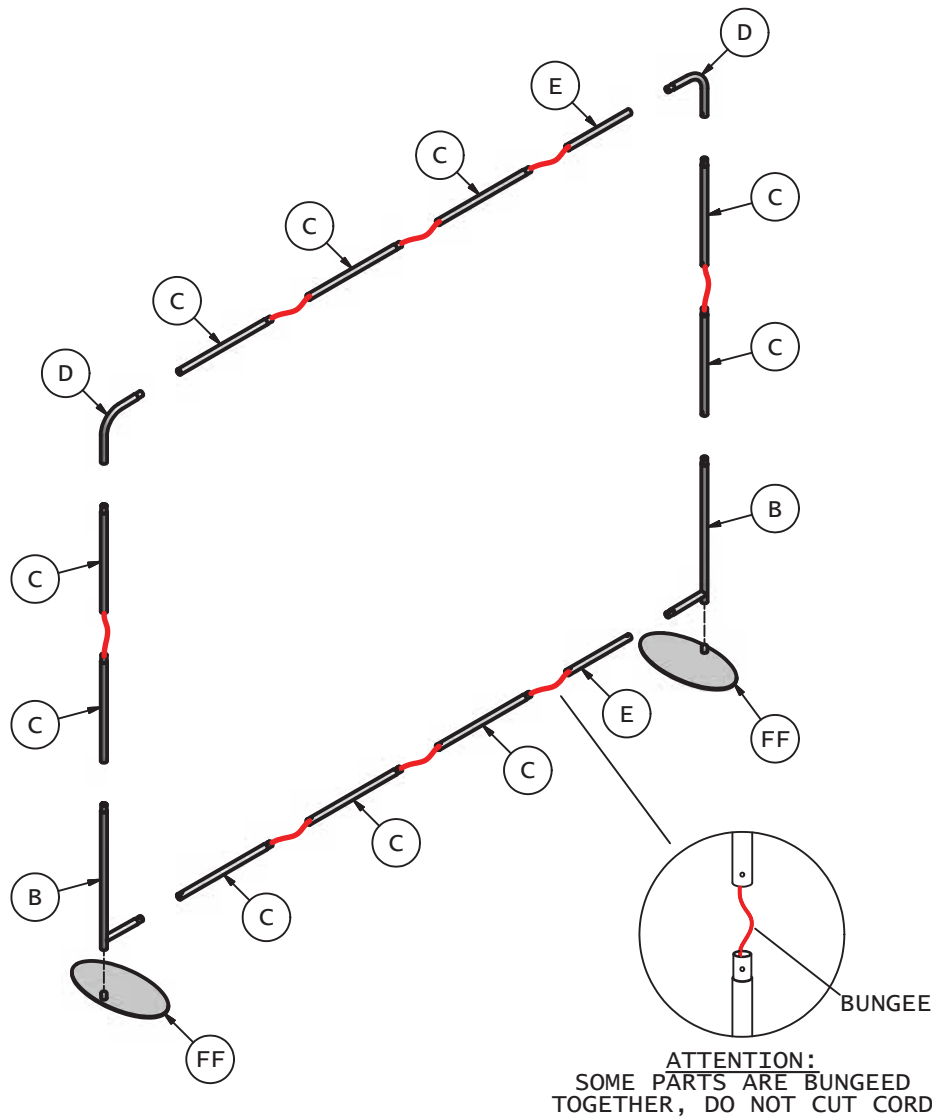

10x10 Layout A

# Assembly Instructions:

## Custom FabLite Display

Assemble the frames as shown below.

1) Assemble the frame by connecting the pieces with matching Letters. Each piece slides into the next piece using the spring lock to secure into place.

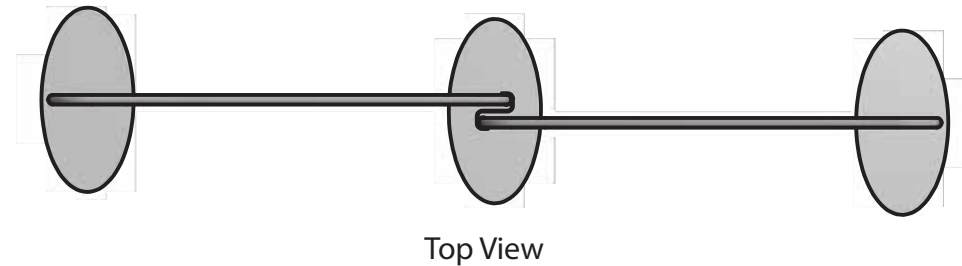
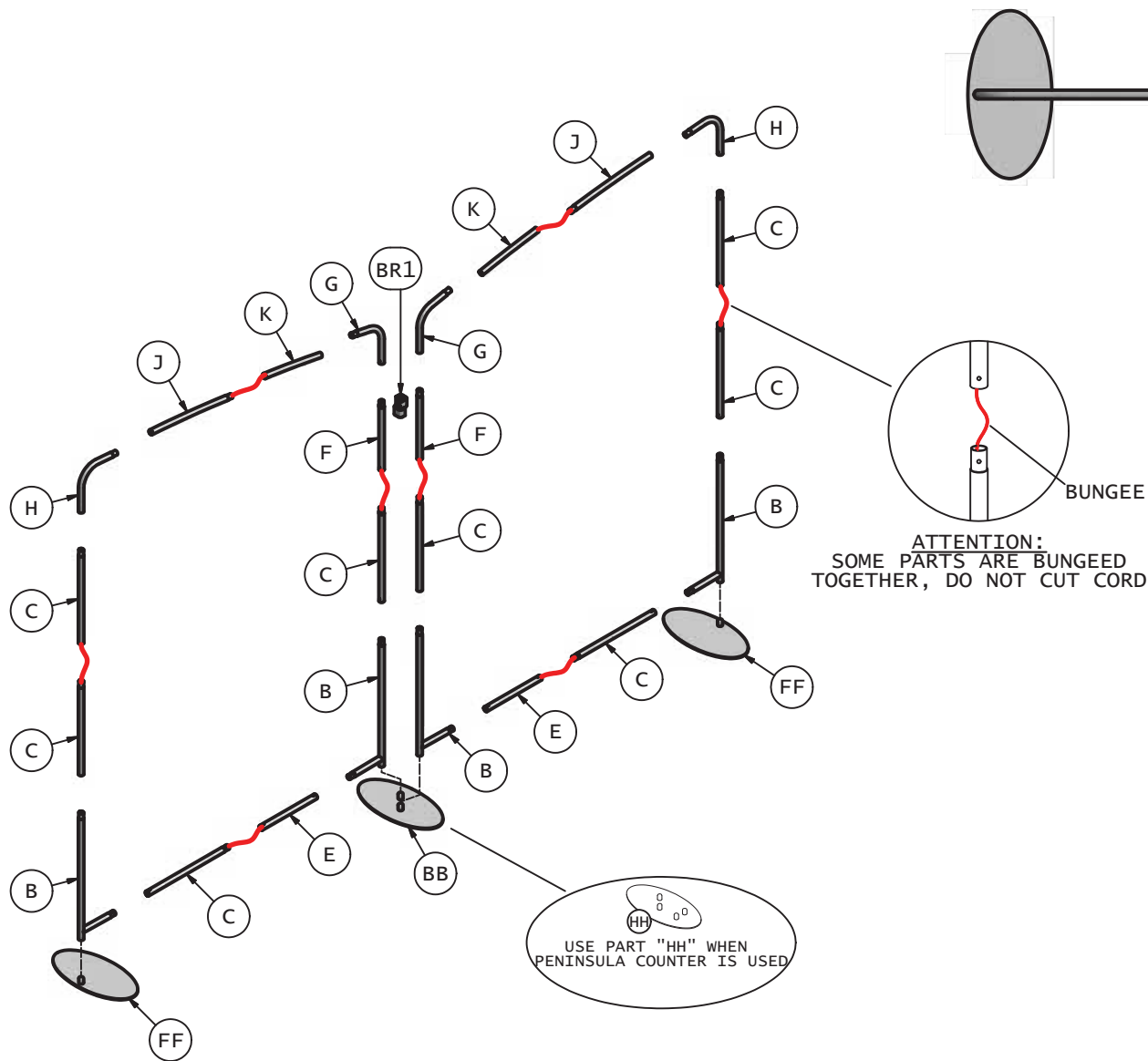

10x10 Layout B

## Assembly Instructions:

## Custom FabLite Display

Install the Fabric Graphics.

When the frame is assembled. Place the Fabric Graphic over the frame and Secure them using the Zippers at the bottom of the print.

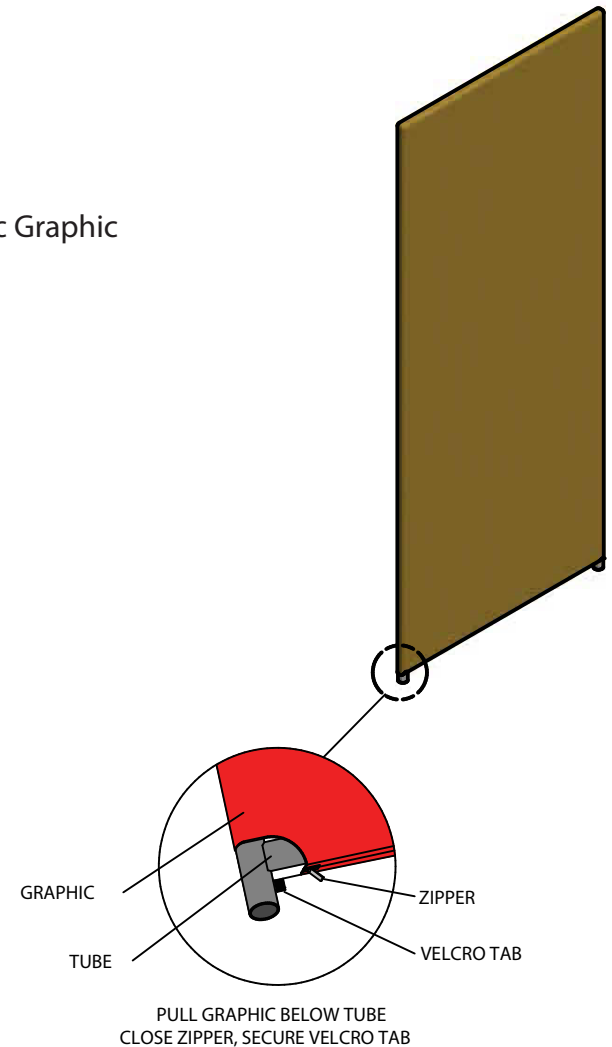

## Assembly Instructions:

## Custom FabLite Display

Install the Fabric Graphics.

When the frame is assembled. Place the Fabric Graphic over the frame and Secure them using the Zippers at the bottom of the print.

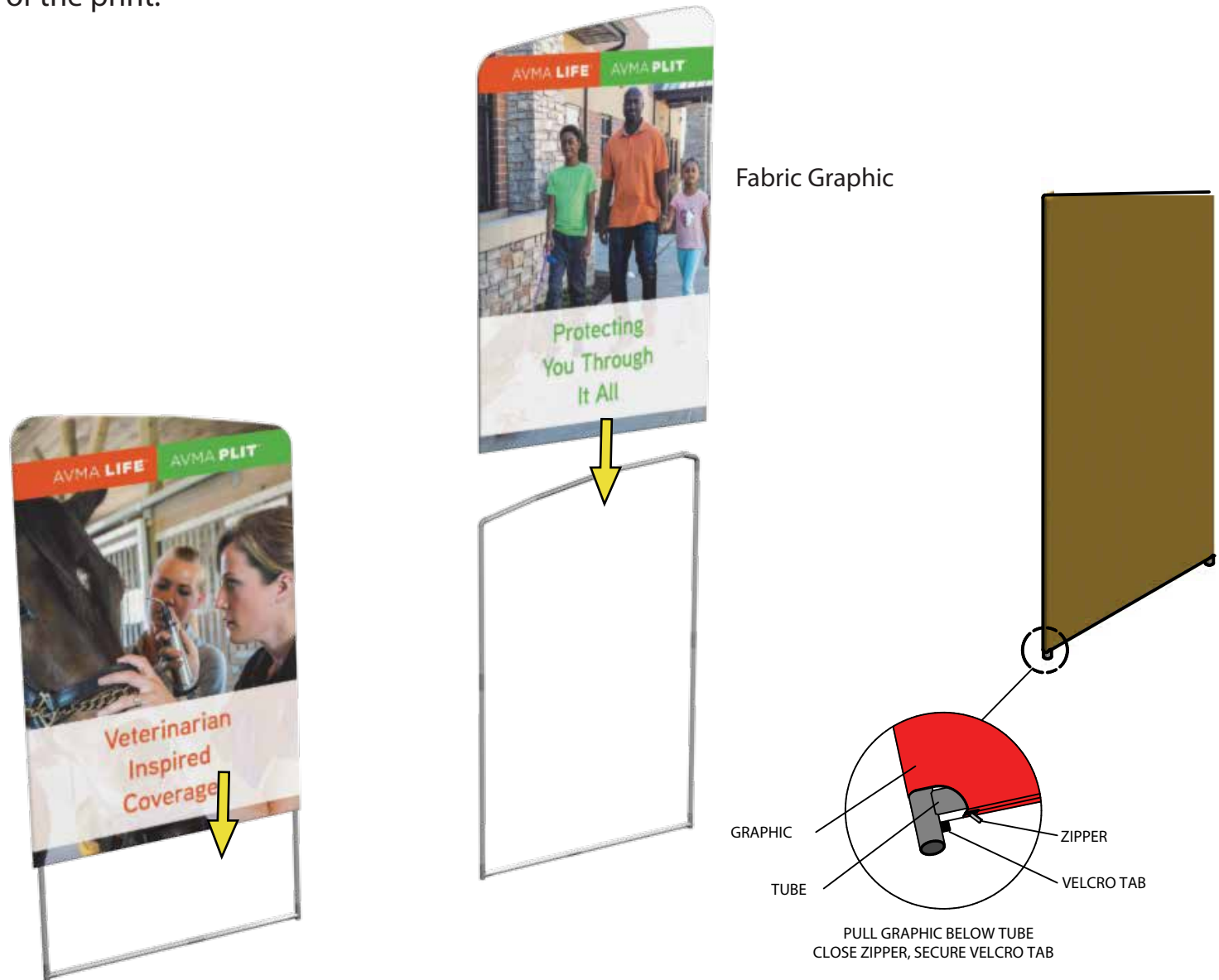

## Assembly Instructions:

## Custom FabLite Display

Finish the assembly of the back wall.

- 1) Connect the Completed frame to the baseplate.
- 2) Lock the frames together using the S-Clip frame connectors.

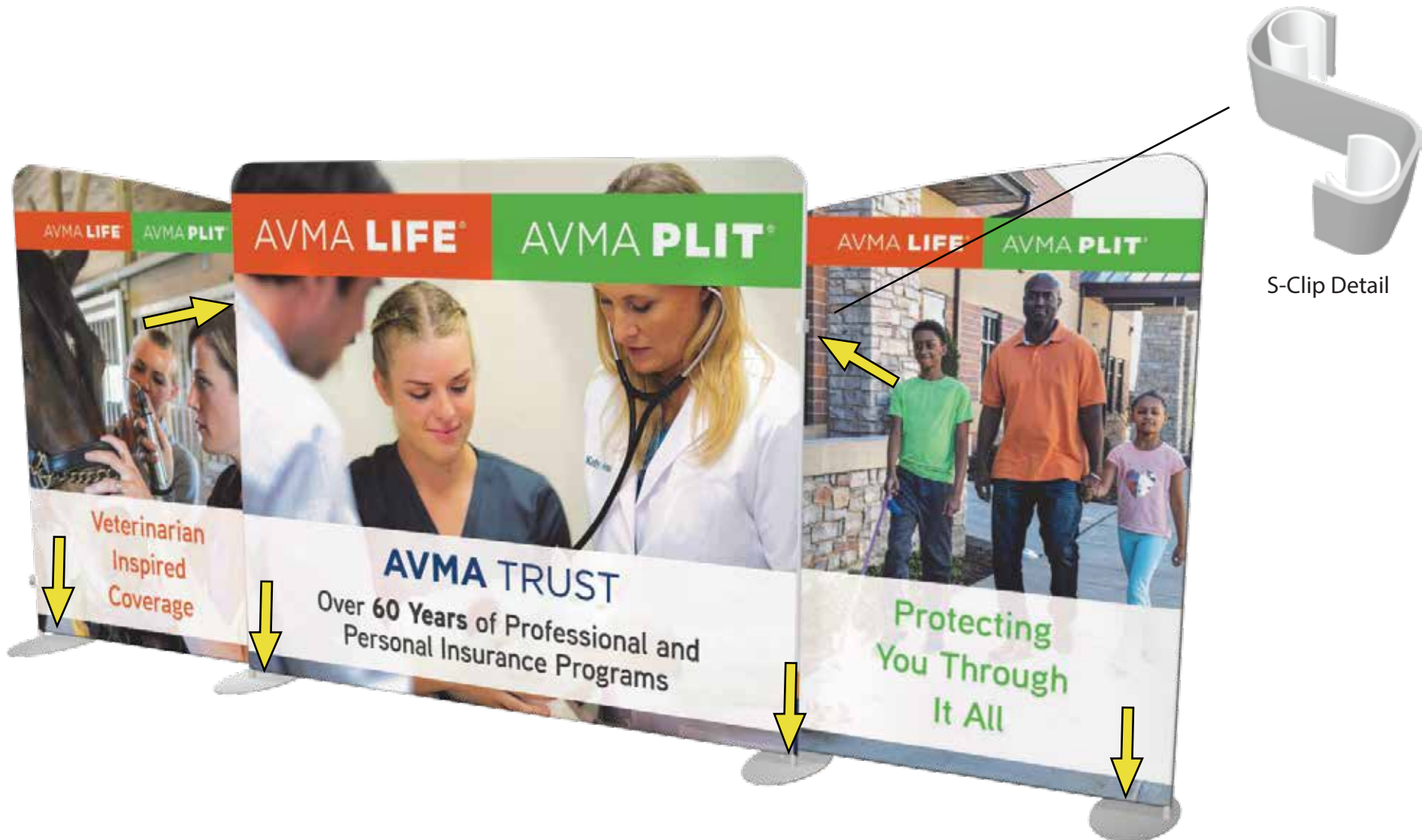

## Assembly Instructions:

## Custom FabLite Display

Connect the Desired Placards To the Side wall.

- 1) Thread the Thumb screws through the Placards into the back wall Clips.
- 2) Connect the Placards to the back wall.





# Assembly Instructions:

## Custom FabLite Display

Assemble the Counter from the carrying cases as shown below.

1) Open the case and unpack the content.

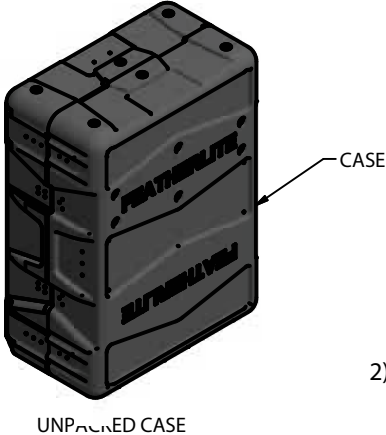

2) With the case still open, stand upright.

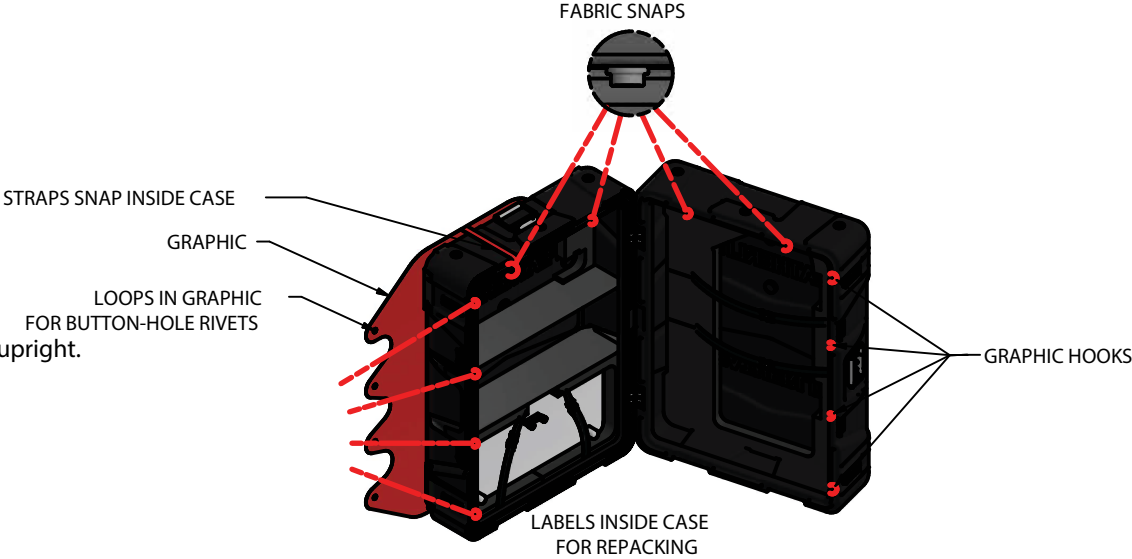

5) Place the counter top on the case, aligning the magnets with the whole on top of the case it will snap into place. Unfold the counter top to secure the other side.

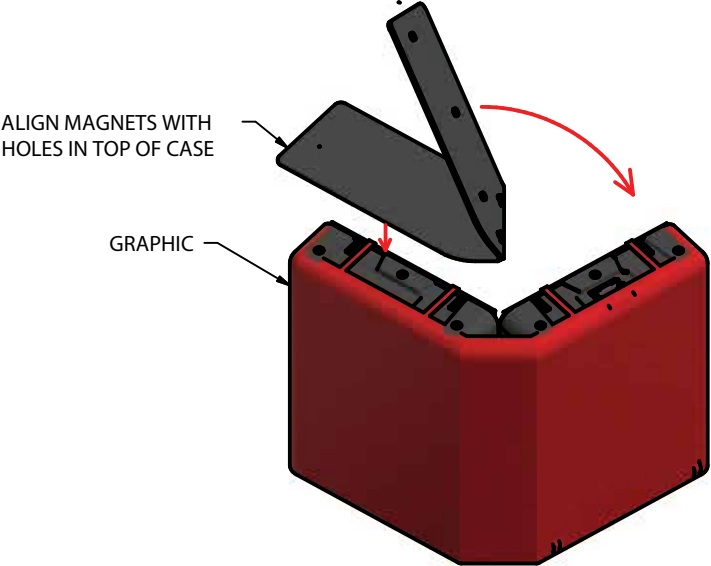

COMPLETED UNIT

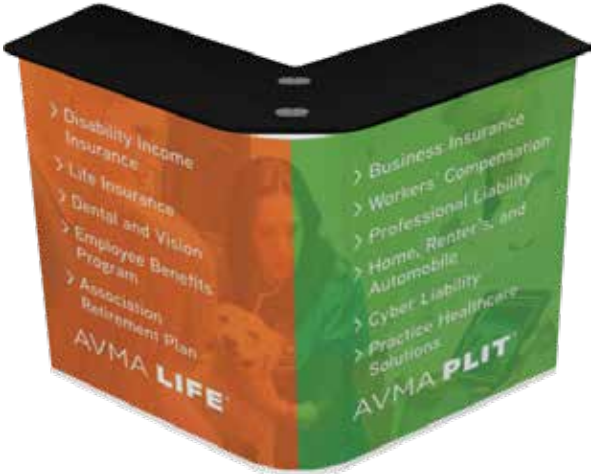

## Assembly Instructions:

### Custom FabLite Display

Install The Stem Lights as shown below.

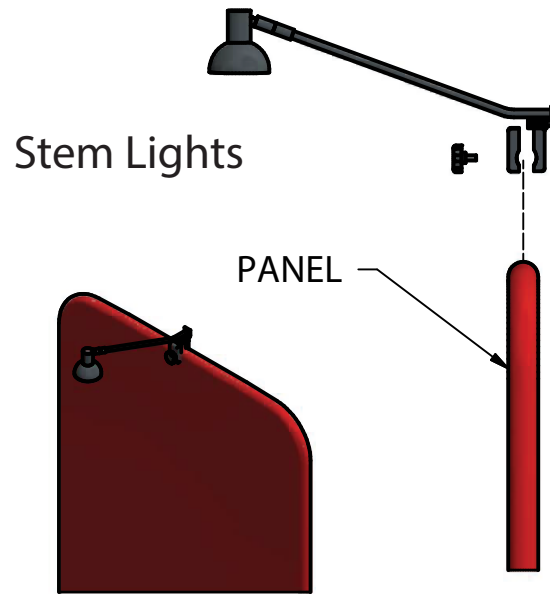

ATTACHMENT:  
LIGHT CLAMPS ONTO DISPLAY BY  
TIGHTENING THUMBSCREW



## Assembly Instructions:

## Custom FabLite Display

### Case Layout

Pack the booth components for the 10'x20' Booth in the case in the following manner:

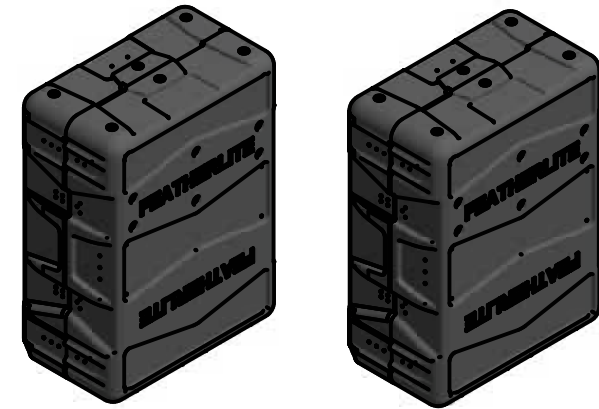
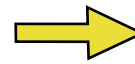

View showing Typical Shipping Cases

### Booth Components

#### Case 1



- 1) Back wall Aluminum Extrusions
- 2) Counter/Case Components
- 3) Graphics
- 4) LED Lights
- 5) Drop Cloth kit
- 6) Power supply/cords
- 7) Stem Lights

#### Case 2



- 1) Back wall Aluminum Extrusions
- 2) Counter/Case Components
- 3) Graphics
- 4) LED Lights
- 5) Drop Cloth kit
- 6) Power supply/cords
- 7) Stem Lights