

Assembly Instructions:

20' x 20' InfiniTruss - IT2020-01

IT2020-01 Truss Components are shown below:

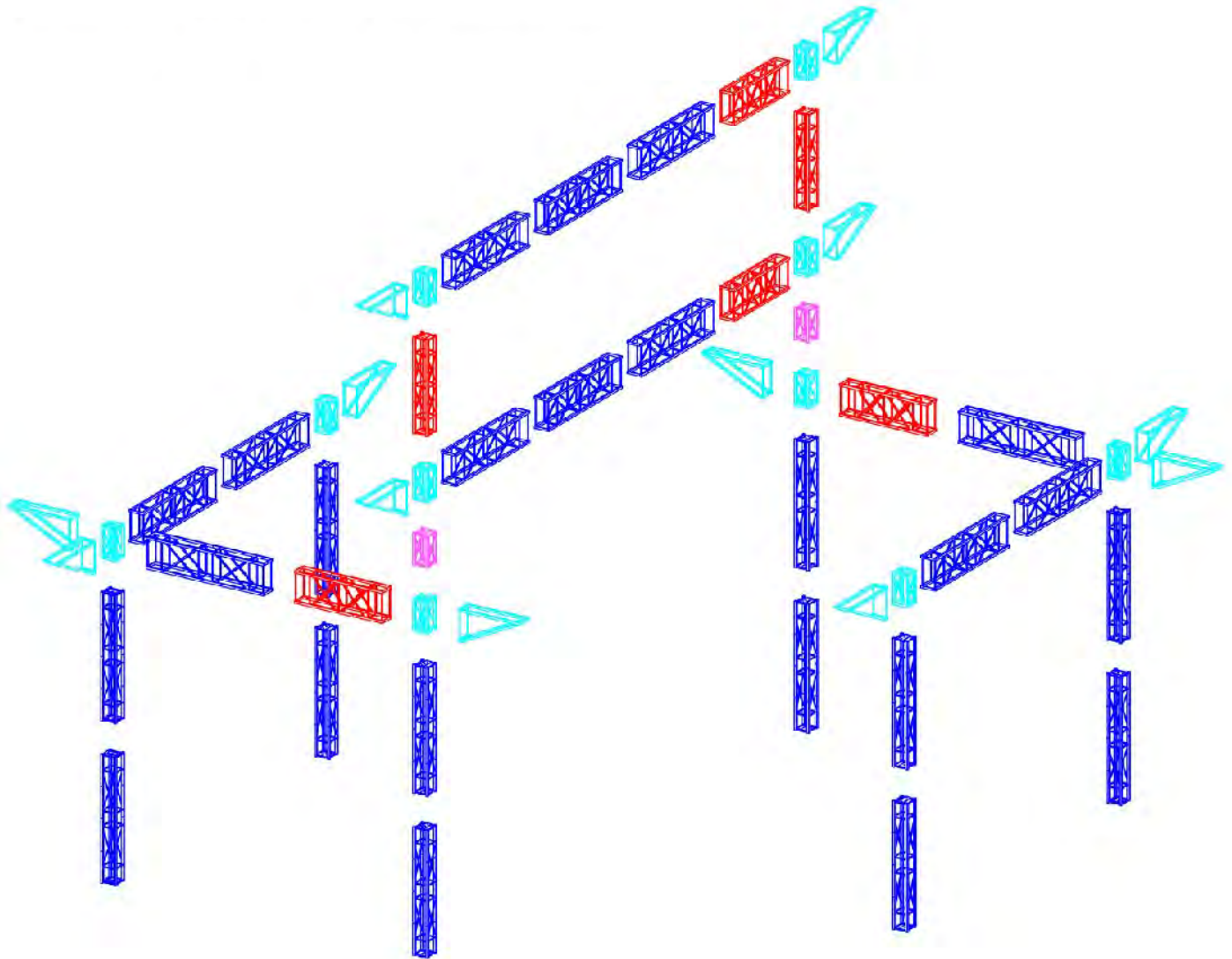

LEGEND

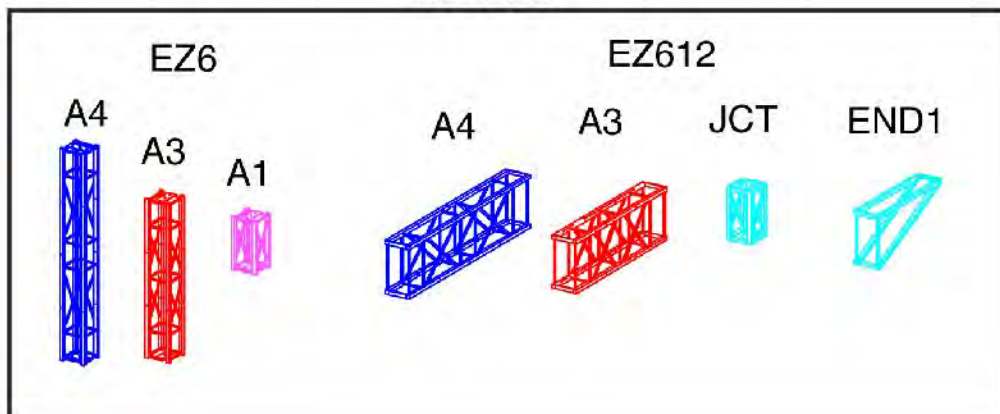

Assembly Instructions:

20' x 20' InfiniTruss - IT2020-01

Connect Leg Assembly pairs together with Carriage Bolts at Endplates.

A) Orient Truss sections so that the two square openings in the Endplates are aligned.

B) Insert Carriage Bolts through the two aligned square openings.

C) Thread a Wingnut onto each Carriage Bolt and hand-tighten. DO NOT use a wingnut wrench.

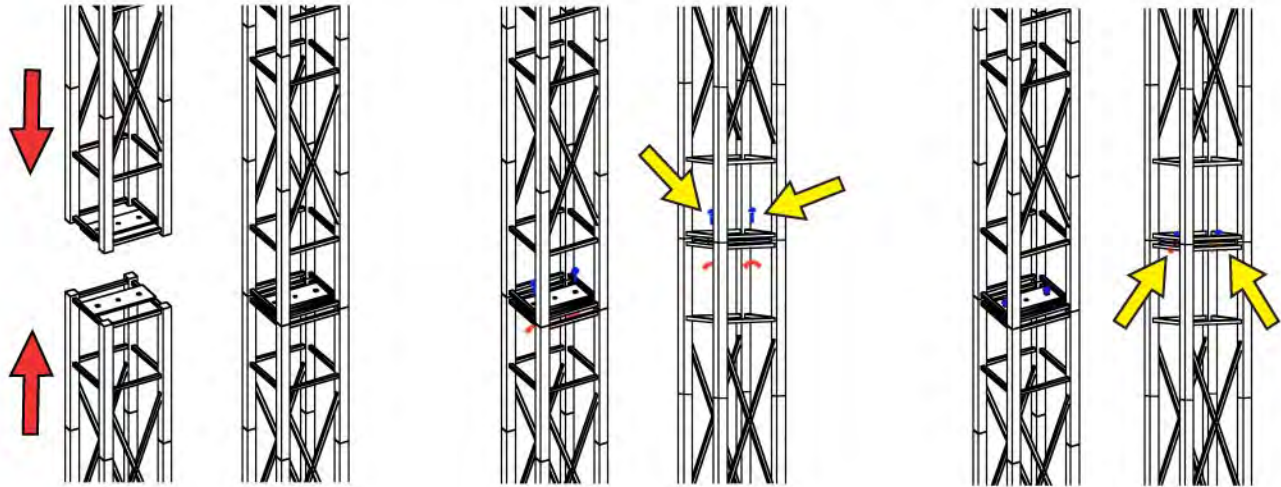

Detail view showing two Trusses, Endplates, Carriage Bolts, and Wingnuts.



Assemble Truss Units together at right angles with Corner Brackets.

A) **Upper Truss:** Insert the Corner Bracket into Truss vertically as shown. Hang the Bracket off the top wire with the lower hooks behind the lower wire.

B) **Lower Truss:** Insert Corner Bracket into Truss vertically as shown. Hang the Bracket off the upper wire with the lower hooks behind the bottom wire.

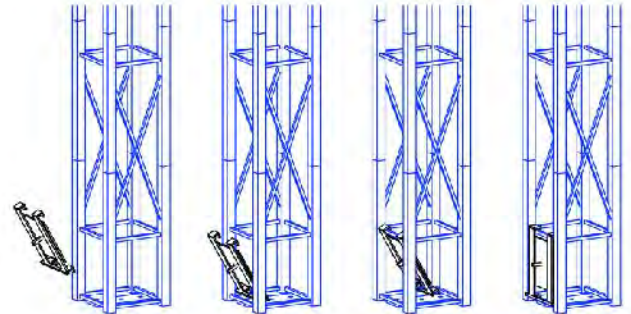
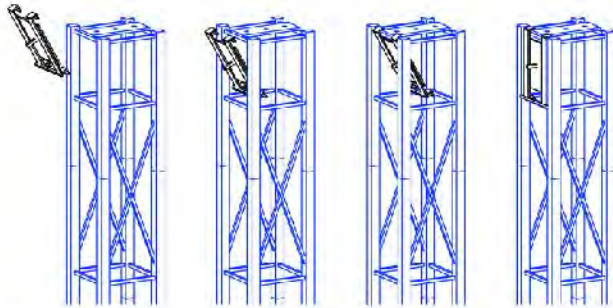

C) Attach horizontal Truss so that the stud on the Corner Bracket passes through the center opening of the Endplate. Lock components into position using wingnut. Ensure that the alignment rod on the Corner Bracket is seated between the Truss cords.

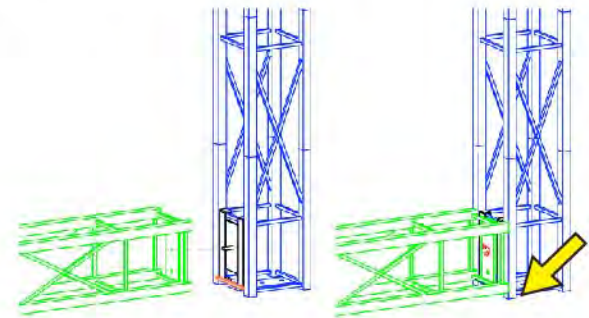
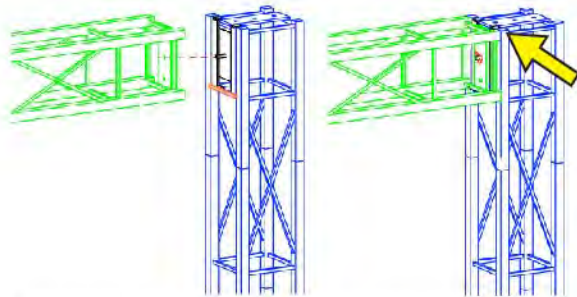

Upper horizontal Trusses mount flush with the top of the upright.

Base horizontal Trusses mount 1/2" off the floor.

Detail views showing typical steps to Corner Bracket assembly.

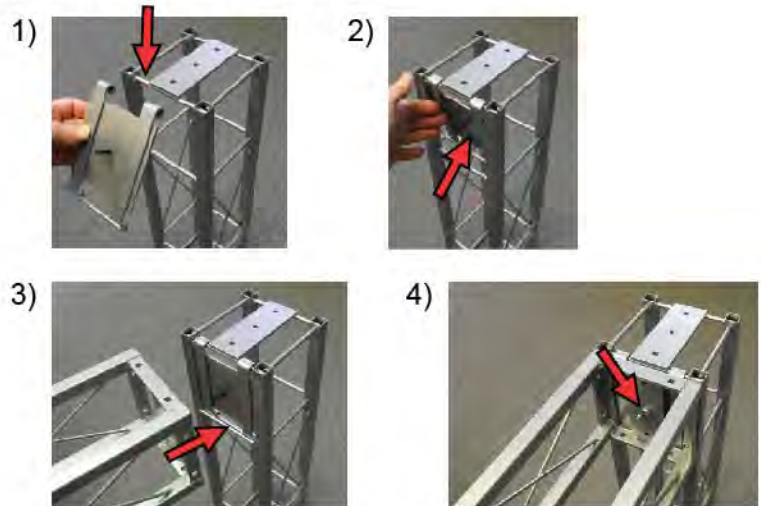
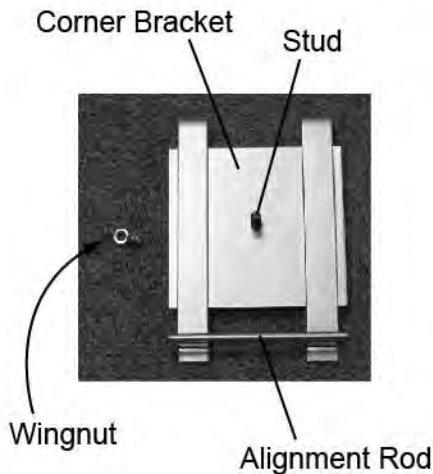

Unroll the Fabric Graphics and attach to the Truss frame with Banner Clips.

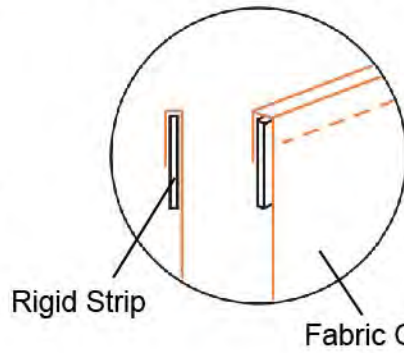

Rigid strips are sewn into the top and bottom ends of the banners (Fabric Graphics).

Fabric Graphics may be on either side of the Truss frame. The top seam on the banner will determine which side of the graphic faces forward.

- A) Slide the rigid edge of the banner down into the hook end of the Banner Clip about every two feet. Attach Banner Clips onto Truss tube.
- B) Alternately, you can attach the clips to the Truss first with the hook end facing out then firmly insert the graphic into the clip.

Banner Clip

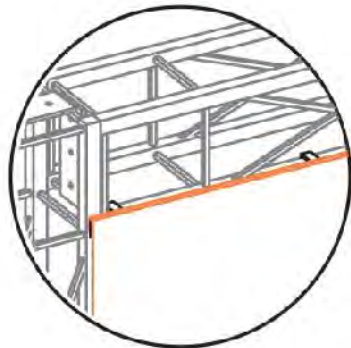
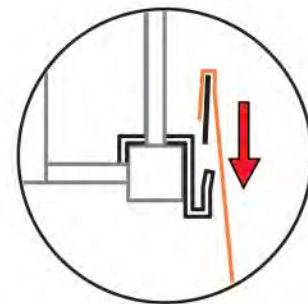
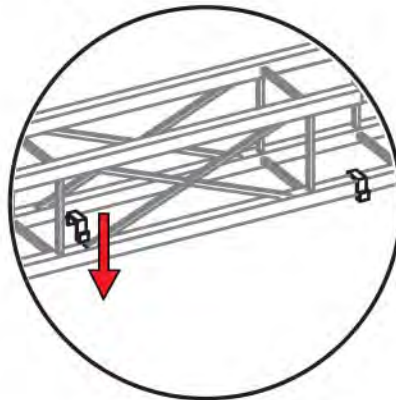
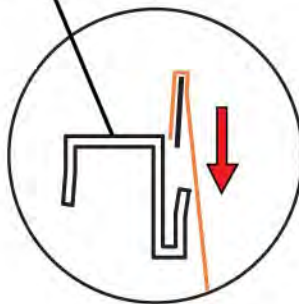

- C) Repeat the procedure along the bottom edge of the graphic in the reverse direction.



Assembly Instructions:

20' x 20' InfiniTruss - IT2020-01

Attach Internal Shelves to frame with Shelf Brackets.

A) Connect Shelf Brackets to Truss frame at desired locations.

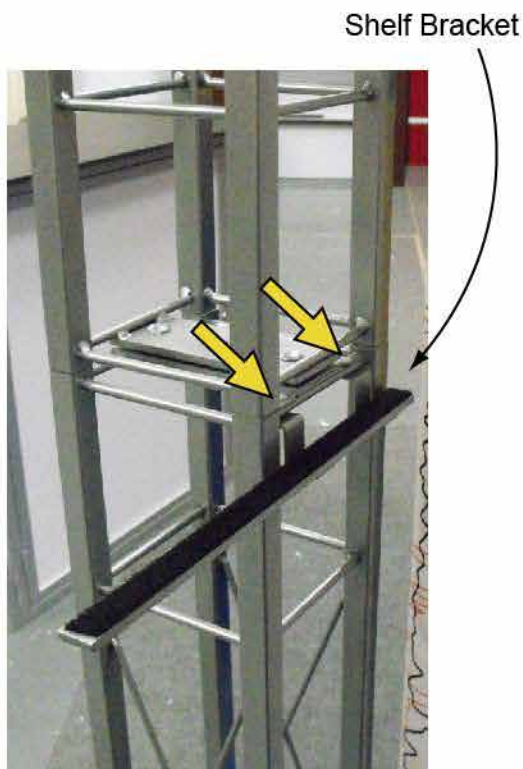

B) Attach Internal Shelves to Shelf Brackets with Velcro.

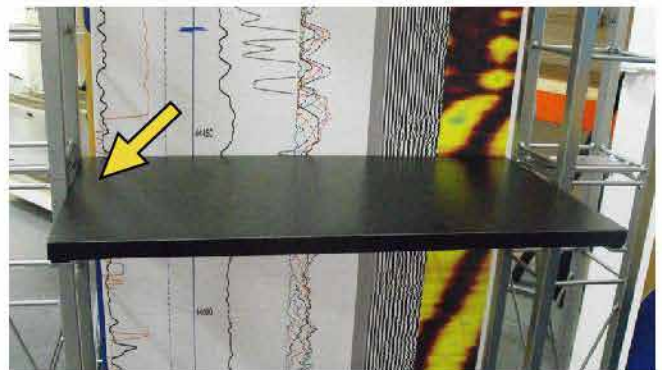
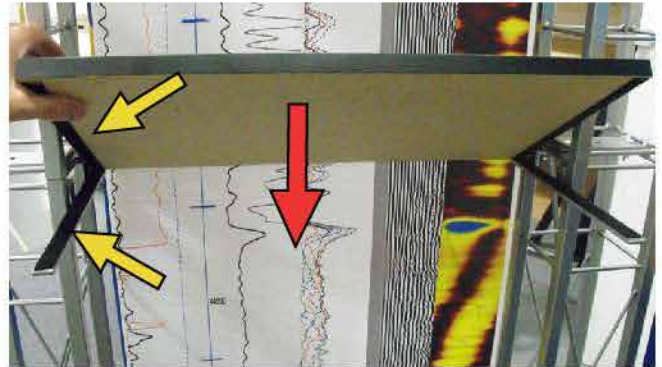

Attach External Shelves to Truss frame and secure with thumbscrews.

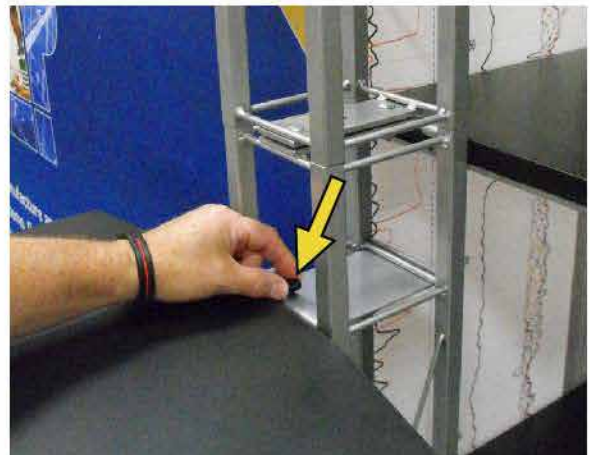

Attach Flat Screen Mounts to Truss frame and secure with thumbscrews.



A) Attach Flat Screen Mount to Truss frame. Swivel the frame so that it is facing the desired direction and tighten the top bolt to secure in place.

B) Attach crossbar and plastic spacers at choice of openings on frame and tighten securely with wingnuts.

C) Mount J-clips to monitor in the top two mounting holes using the bolts supplied by the monitor manufacturer.

D) Hang J-clips onto crossbar and tighten with provided thumbscrew to secure.

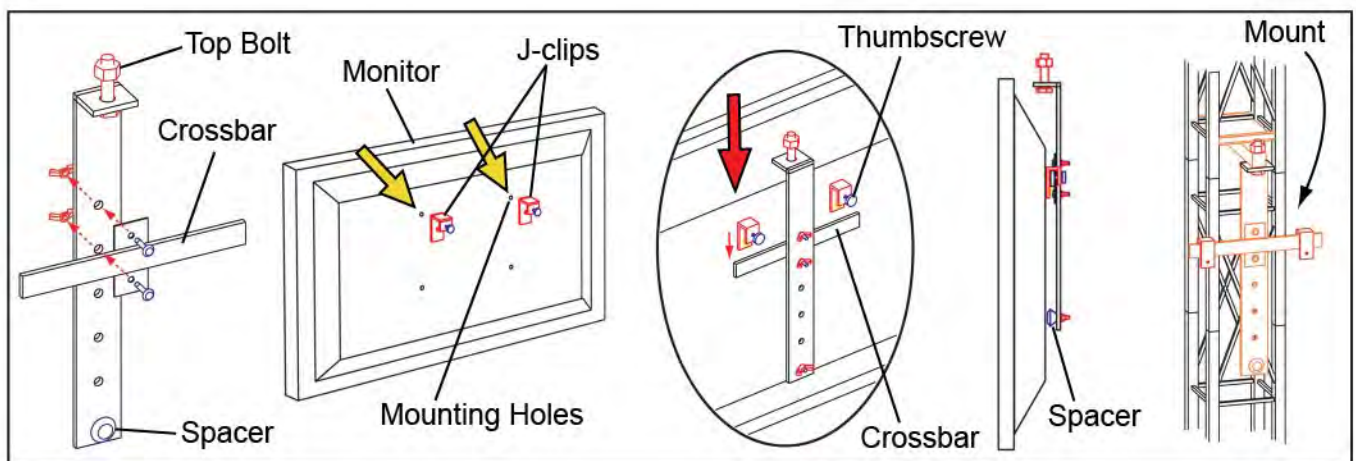

Assembly Instructions:

20' x 20' InfiniTruss - IT2020-01

Attach Lights to Truss frame at desired locations and tighten with thumbscrews.



Displays are packed and shipped in Tubs and/or Cases (depending on the size and number of components used for the Booth Display).



Shipping Tub



Shipping Cases