

THAMES & KOSMOS

Display Setup Instructions



10' x 30' Display Booth





14" x 14" Pillar
5

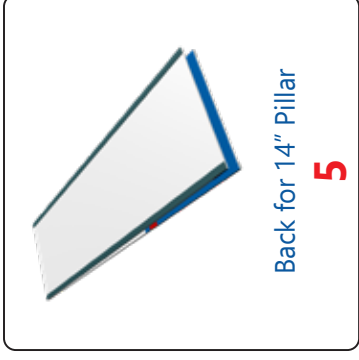

Back for 14" Pillar
5

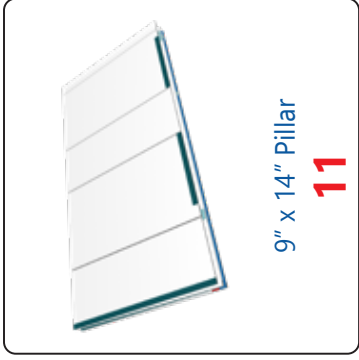

9" x 14" Pillar
11

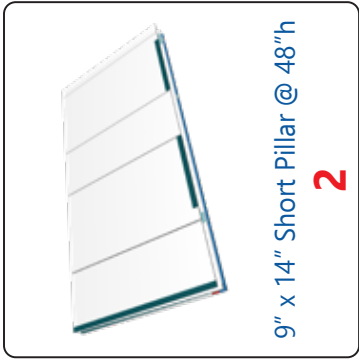

9" x 14" Short Pillar @ 48"h
2

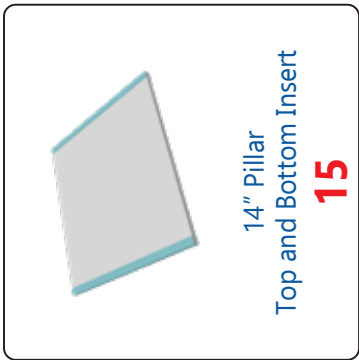

14" Pillar
Top and Bottom Insert
15

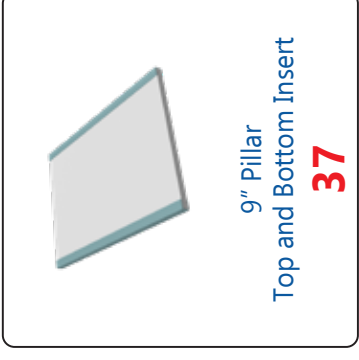

9" Pillar
Top and Bottom Insert
37

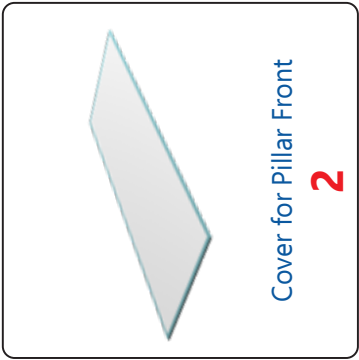

Cover for Pillar Front
2

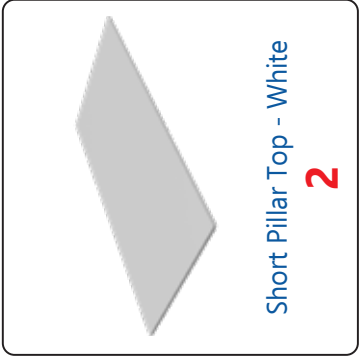

Short Pillar Top - White
2



44" Wall Panel
5



40" Wall Panel
2

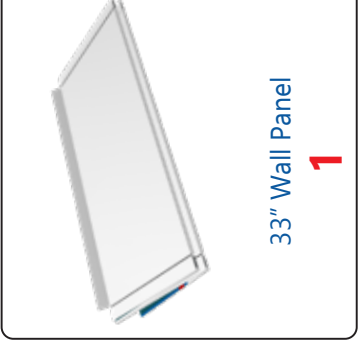

33" Wall Panel
1

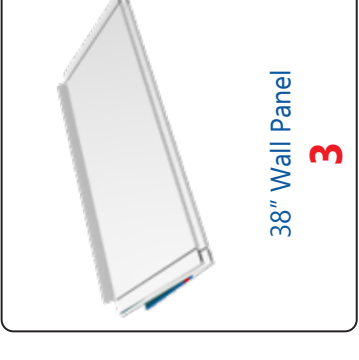

38" Wall Panel
3

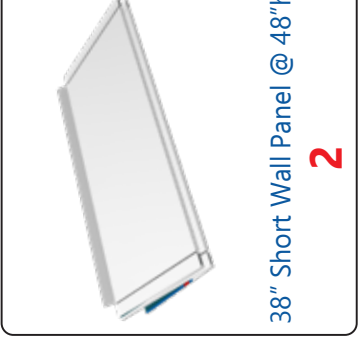

38" Short Wall Panel @ 48"h
2

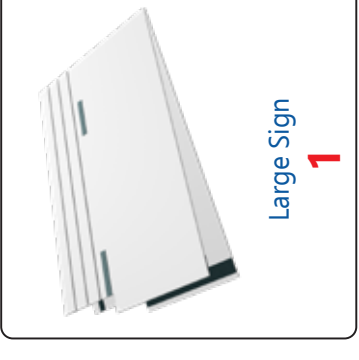

Large Sign
1



Corner Sign 30ft Display
2

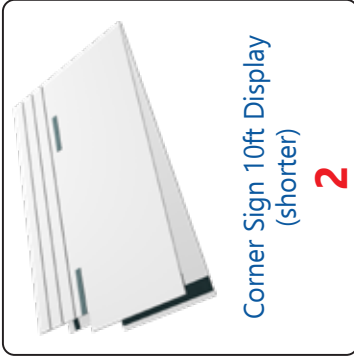

Corner Sign 10ft Display
(shorter) **2**

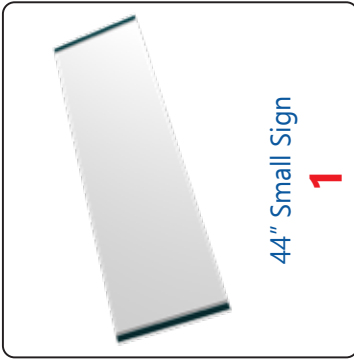

44" Small Sign **1**

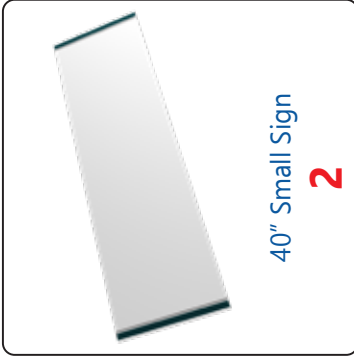

40" Small Sign **2**

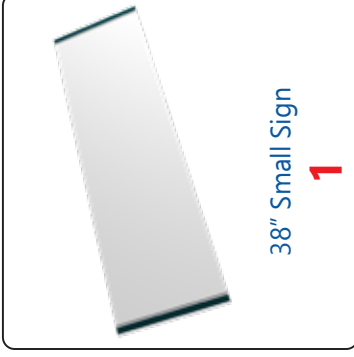

38" Small Sign **1**

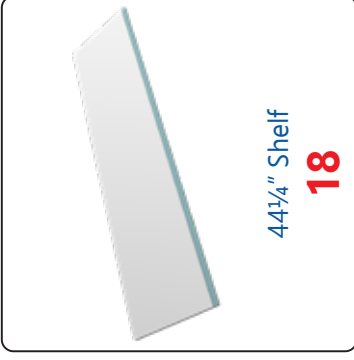

44 $\frac{1}{4}$ " Shelf **18**

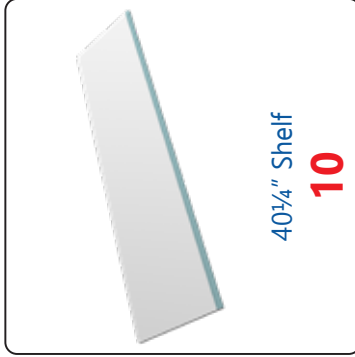

40 $\frac{1}{4}$ " Shelf **10**

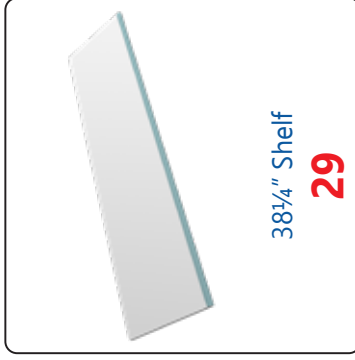

38 $\frac{1}{4}$ " Shelf **29**

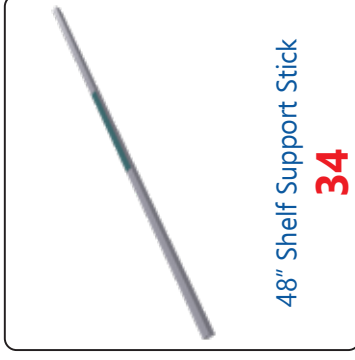

48" Shelf Support Stick **34**

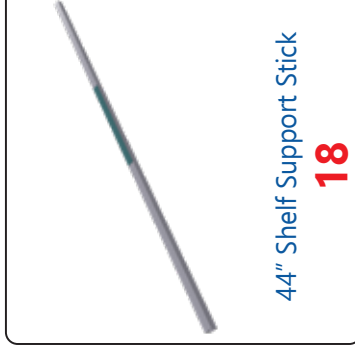

44" Shelf Support Stick **18**

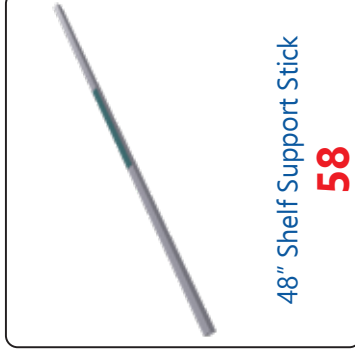

48" Shelf Support Stick **58**

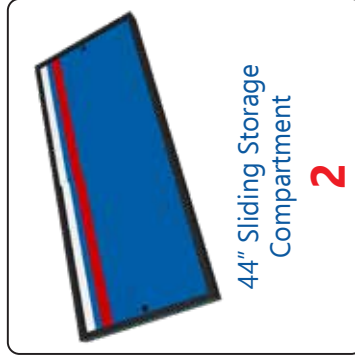

44" Sliding Storage
Compartment **2**

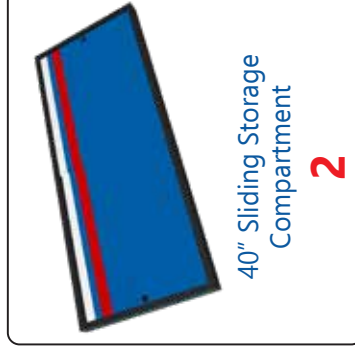

40" Sliding Storage
Compartment **2**

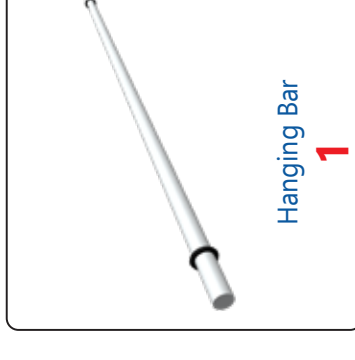

Hanging Bar **1**



White Stem Light - SL518 **12**

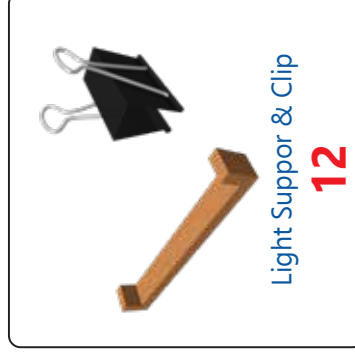

Light Support & Clip **12**

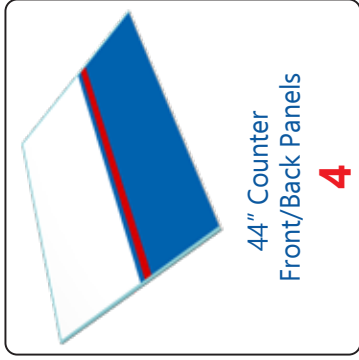

44" Counter
Front/Back Panels **4**

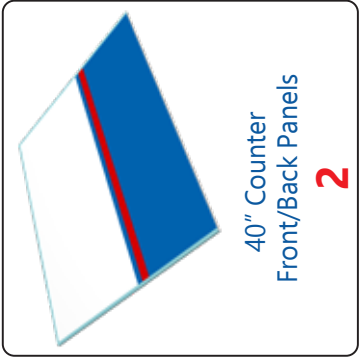

40" Counter
Front/Back Panels **2**

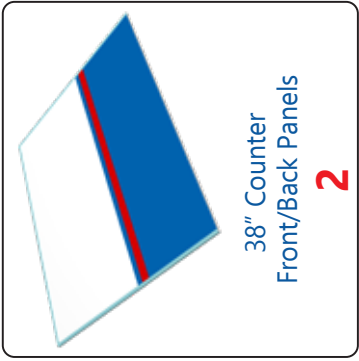

38" Counter
Front/Back Panels **2**

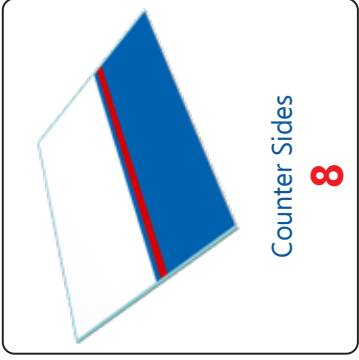

Counter Sides **8**

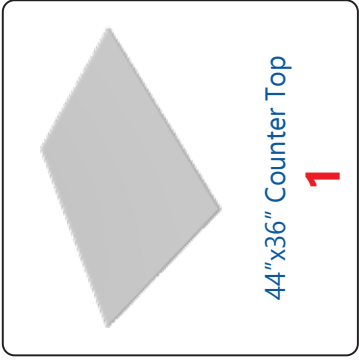

44"x36" Counter Top **1**

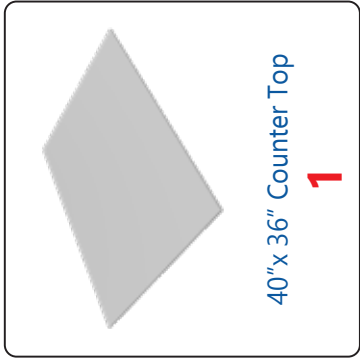

40"x 36" Counter Top **1**

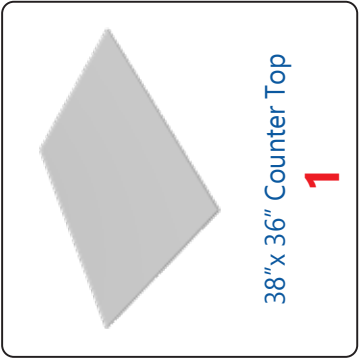

38"x 36" Counter Top **1**

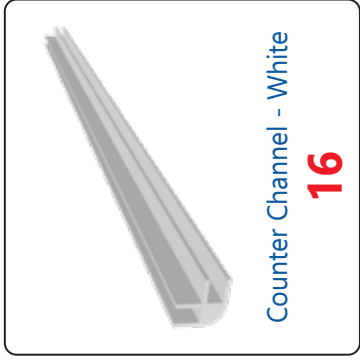

Counter Channel - White **16**



Power/Extension Cord **2**

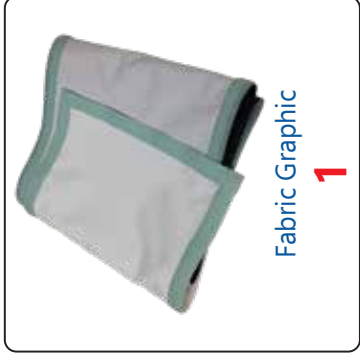

Fabric Graphic **1**



Large Sign Graphic **1**



Corner Sign Graphic **2**



Small Sign Graphic **2**

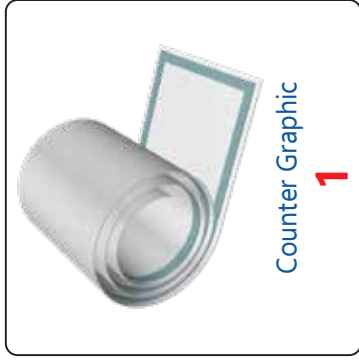

Counter Graphic **1**

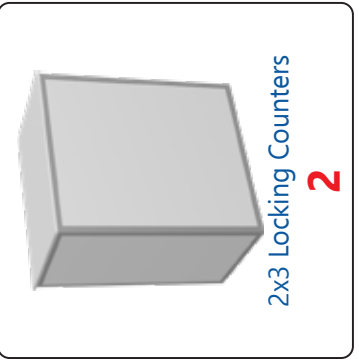

2x3 Locking Counters **2**

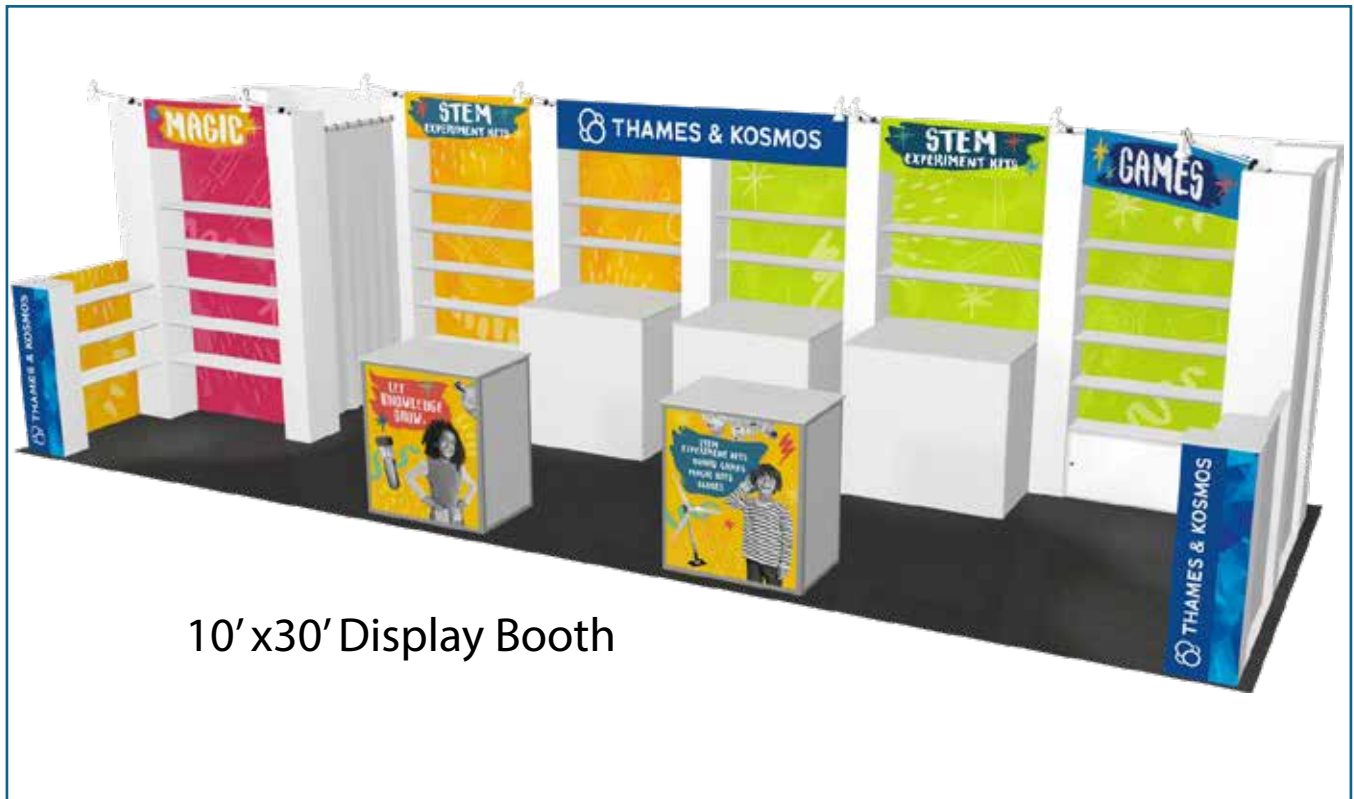

10' x 30' Display Booth

Steps to Assemble the InfiniLite Multi Section Exhibit Booth:

- Step 1: Assemble the Pillars and Corner Pillars.
- Step 2: Place Pillars upright in their proper order and orientation.
- Step 3: Attach Wall Panels to Pillars.
- Step 4: Install Shelf Support Bars and Light Bars into sides of Pillars.
- Step 5: Install Storage Doors.
- Step 6: Attach Shelves to Shelf Support Bars with Velcro.
- Step 7: Attach Signs to inside of Pillars with Velcro
- Step 8: Install Hanging bar and curtain
- Step 9: Attach Stem Lights to tops of Pillars.
- Step 10: Build Reception counters and place them within the booth space.

Enter the link below for an instructional video:

<http://youtu.be/-INxoiV-fG4>

Assembly Instructions: InfiniLite 30-05

Assemble the Pillars.

A) Unfold the Pillar Panels with the front sides facing downward.

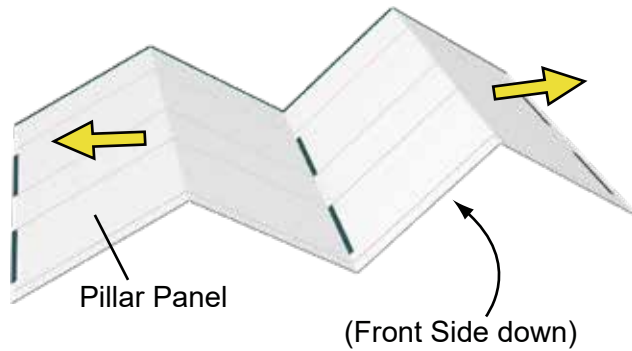

B) Attach the Top, Middle and Bottom Supports to the back of the Pillars with Velcro.

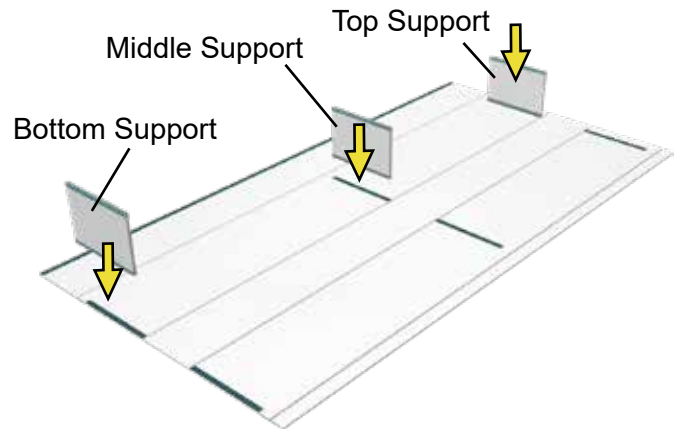

C) Fold Pillar around the Supports and attach with Velcro.

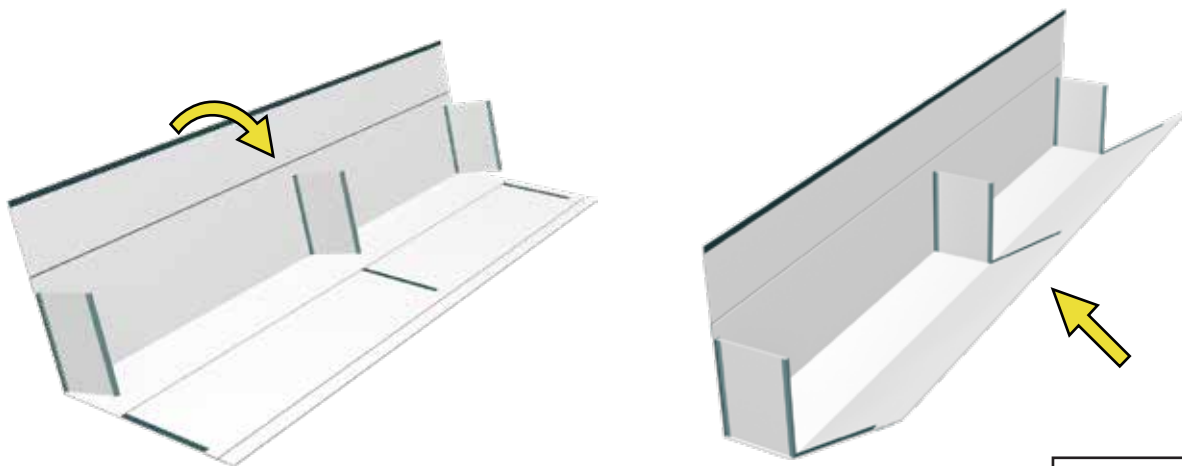

D) Close the Pillar using the Velcro strips along the Pillar edges.

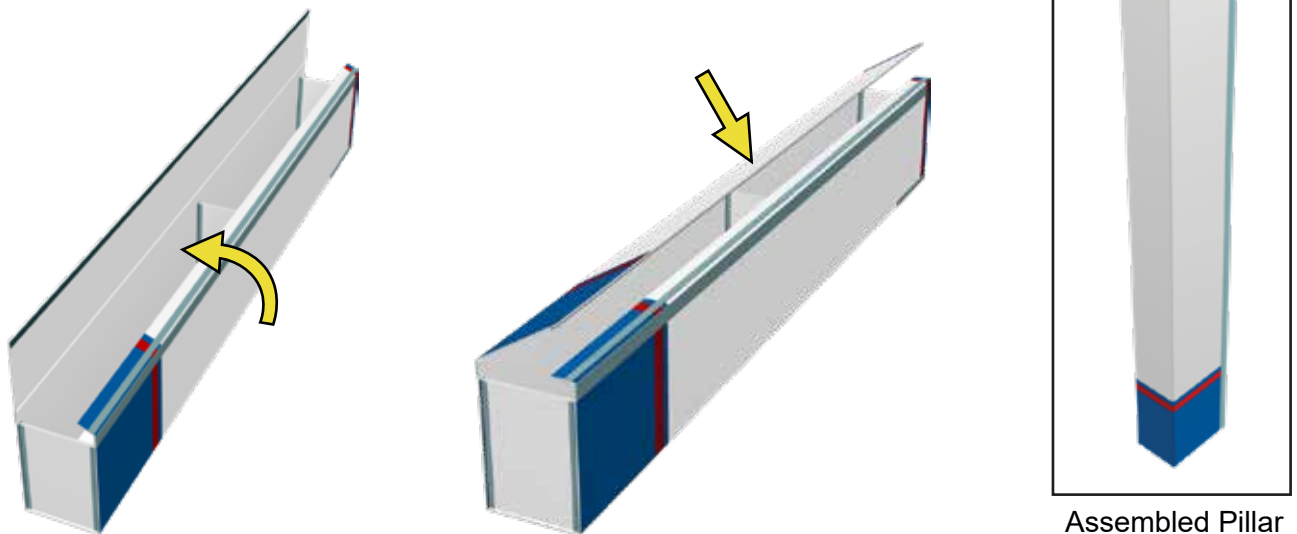

Assemble Corner Pillars.

A) Unfold the Corner Pillar Panels with the front sides facing downward.

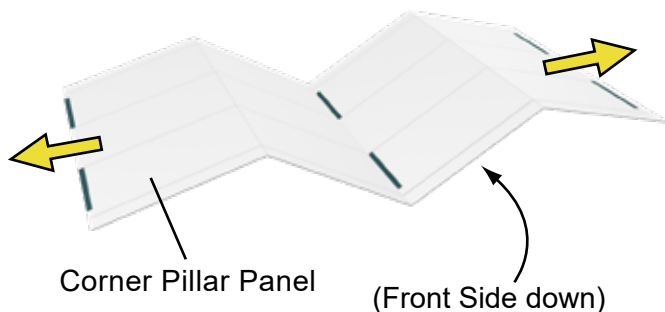

B) Attach the Top, Middle and Bottom Supports to the back of the Corner Pillars with Velcro.

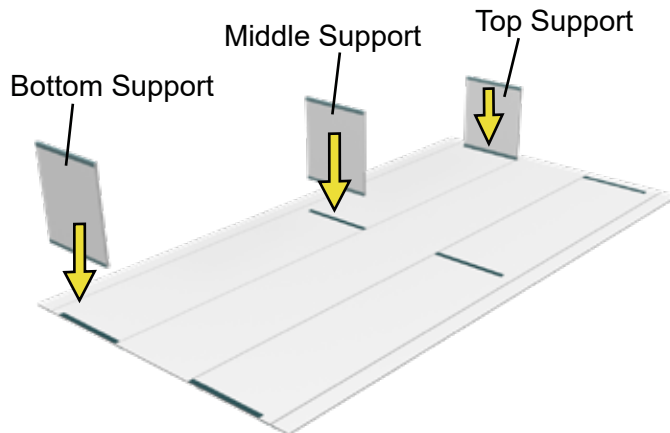

C) Fold the Corner Pillar around the Supports and attach with Velcro.

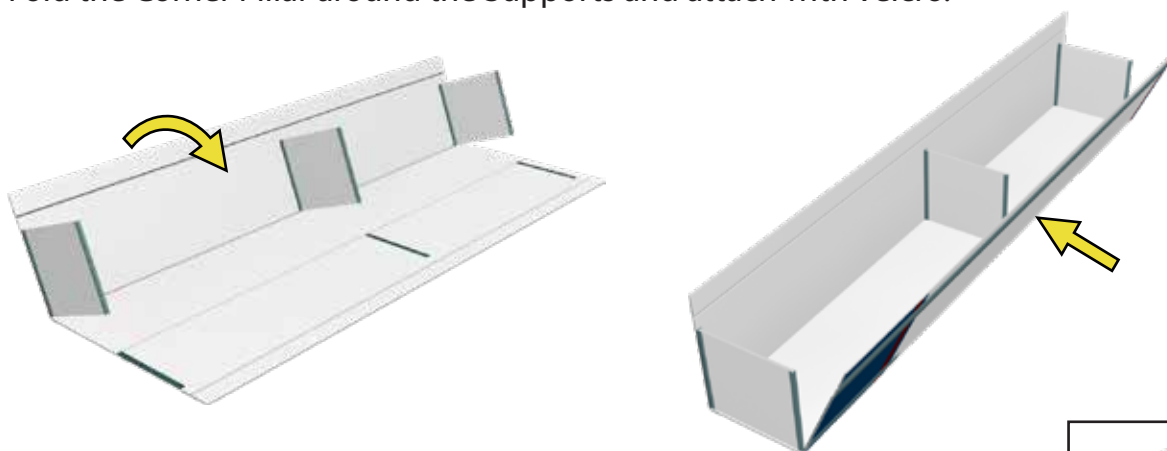

D) Attach the Back Cover to the bottom half of the Corner Pillar with Velcro; unfold the Back Cover; then attach the remaining Back Cover to the upper half of the Corner Pillar.

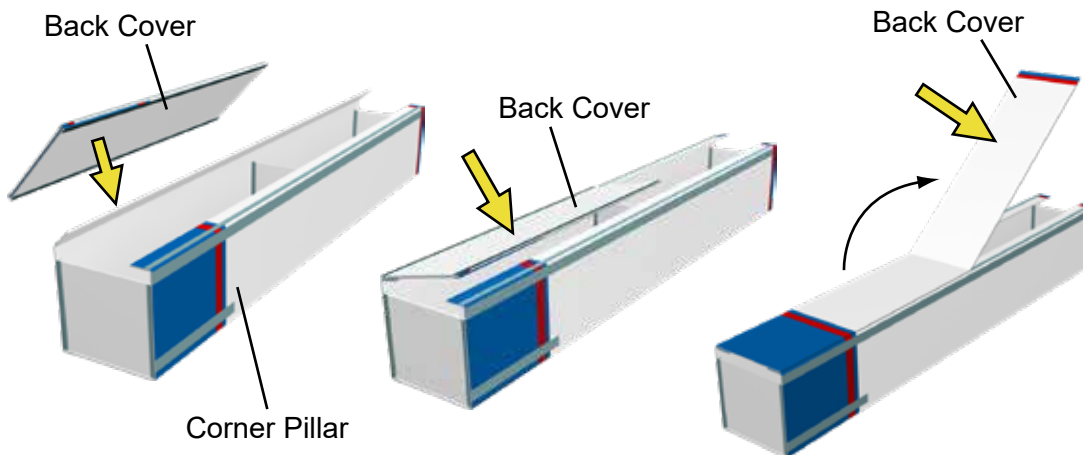

Assembled Corner Pillar

Assembly Instructions: InfiniLite 30-05

Assemble Short Pillars.

A) Unfold the Short Pillar Panels with the front sides facing downward.

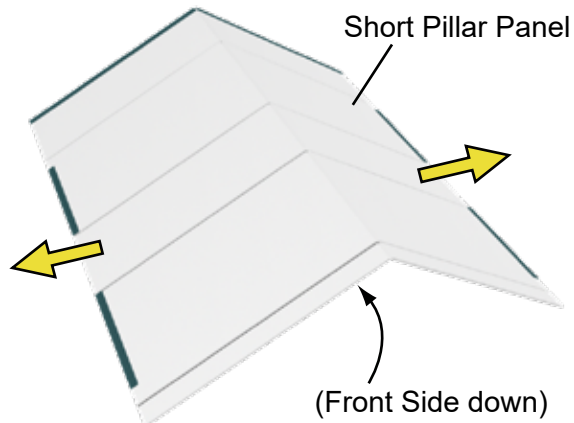

B) Attach Top and Bottom Supports to the back of the Short Pillars with Velcro.

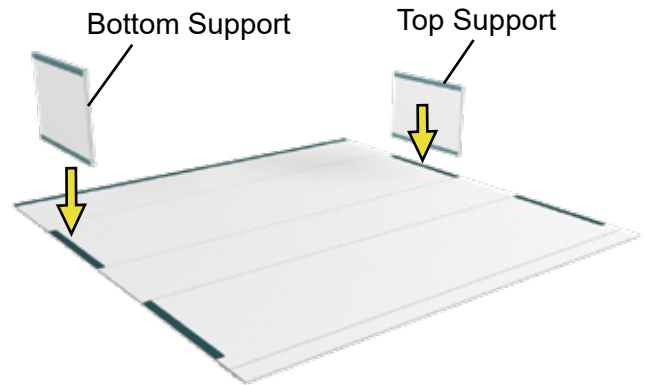

C) Fold Short Pillar around the Top and Bottom Supports and attach with Velcro.

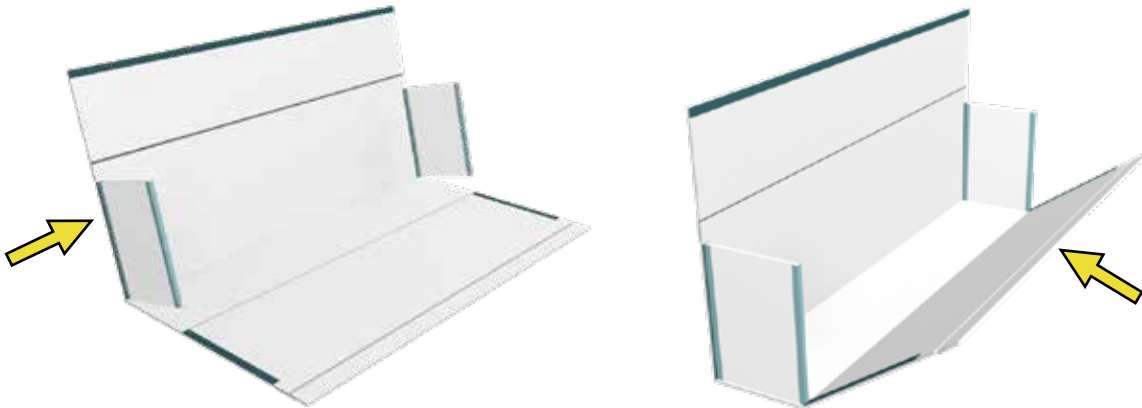

D) Close the Short Pillar using the Velcro strips along the edges.

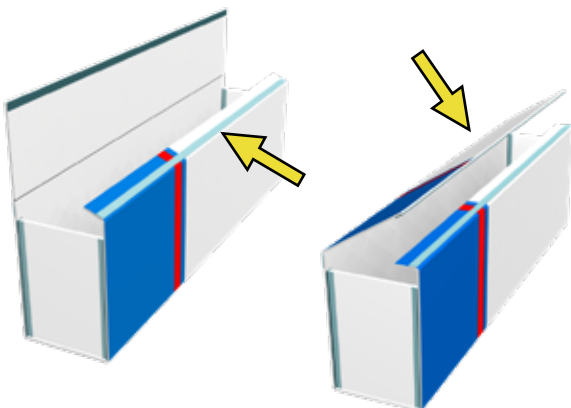

E) Attach Pillar Top to the Short Pillar with Velcro.

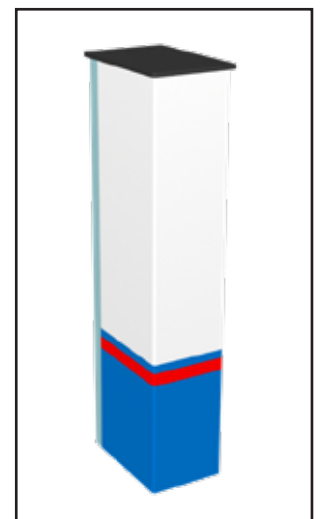

Assembled Short Pillar

Assembly Instructions:

InfiniLite 30-05

The following Floor Plans identifies the locations of the Booth Components when the Display is assembled as a 10'x30'

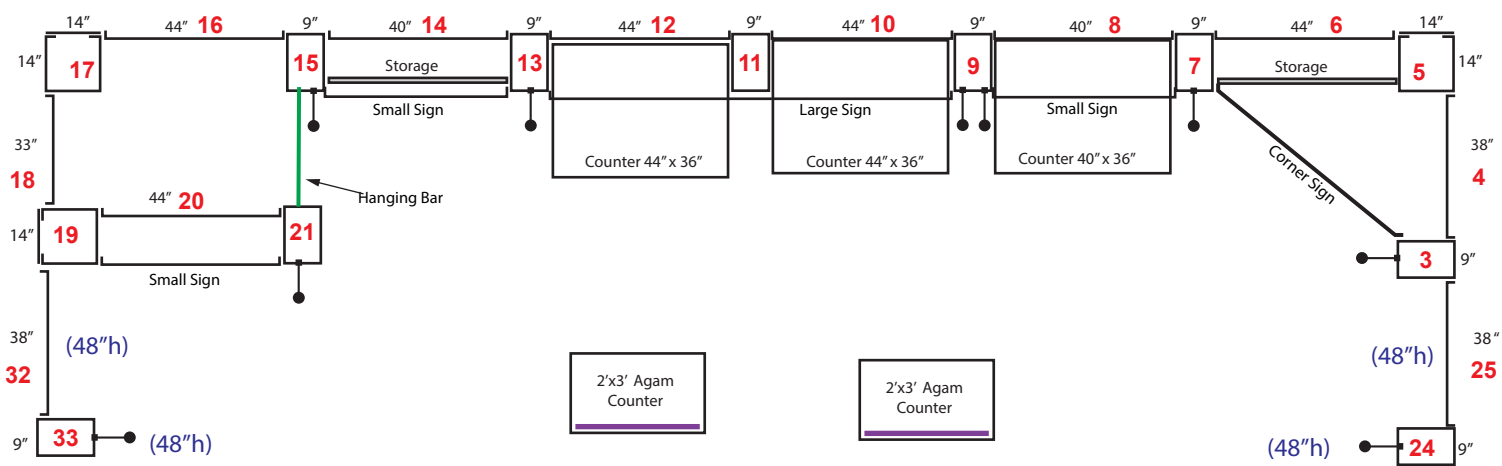

TOP VIEW
Floor Plan A2: 10'x30'

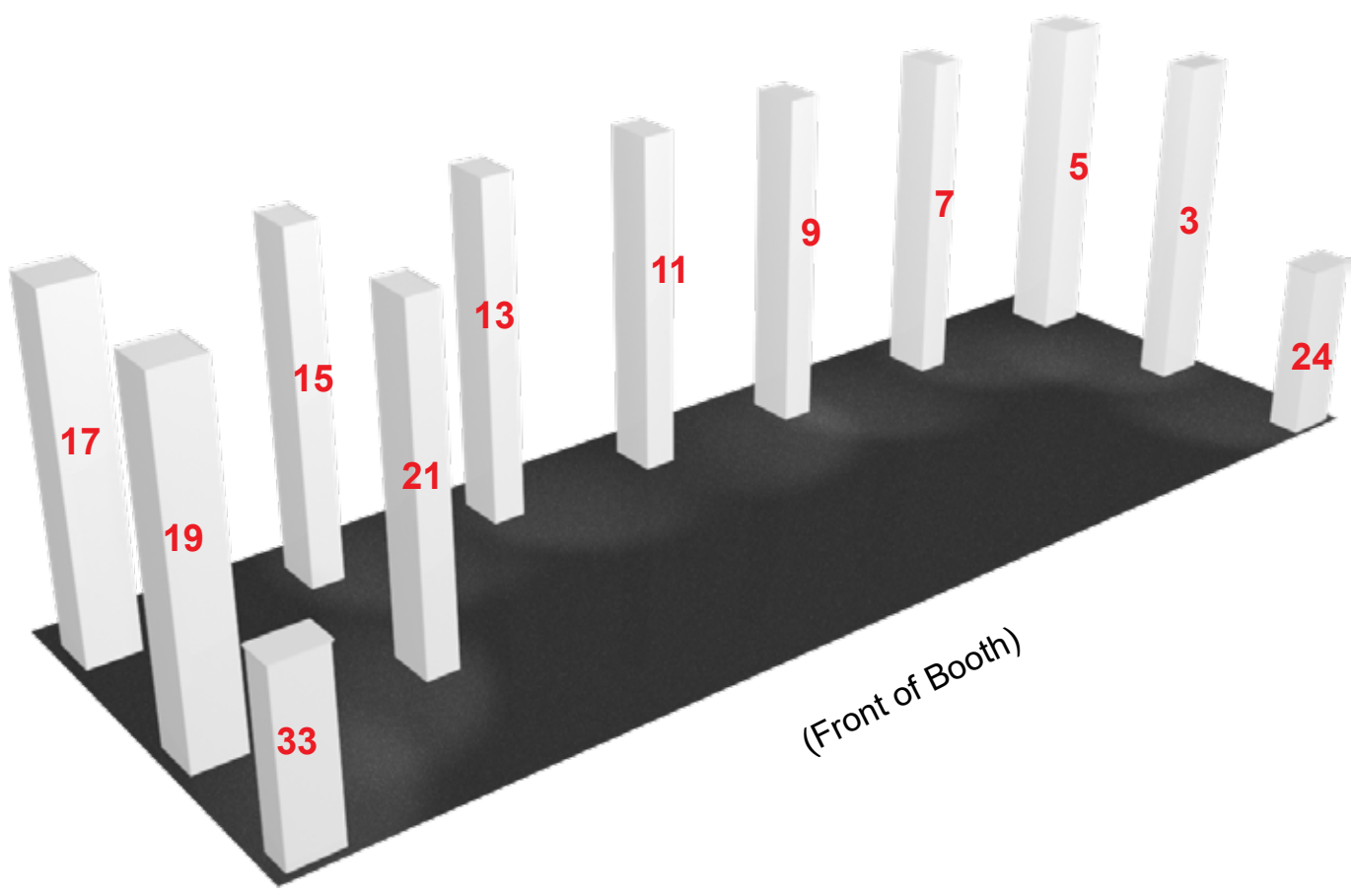

Attach Wall Panels to Pillars.

A) Unfold the bottom half of the Wall Panel, hold upright and attach to the side of the Pillar with Velcro. (Make sure that the Pillar and Wall Panel are flat on the floor surface when attaching and that the accent stripes are aligned with each other.) Begin assembly from either the left or right side of the Booth.

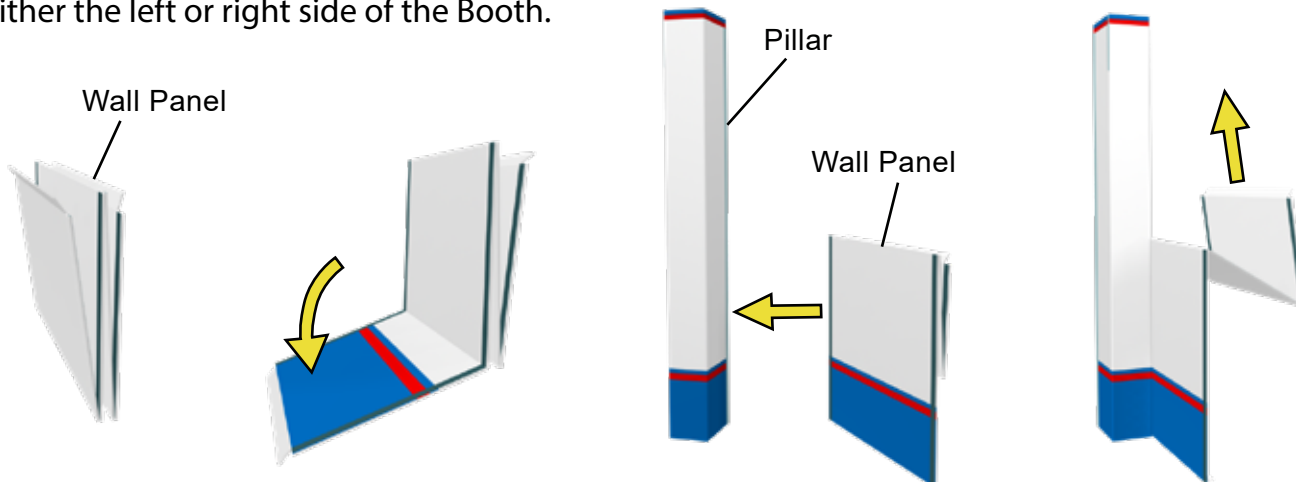

B) Unfold the top half of the Wall Panel and attach it to the top half of the Pillar matching the Velcro strips along the edges. Rotate the Wall Panel into position. Attach the next Pillar to the Wall Panel so that it is flat against the front face of the Wall Panel. Rotate the Pillar into position.

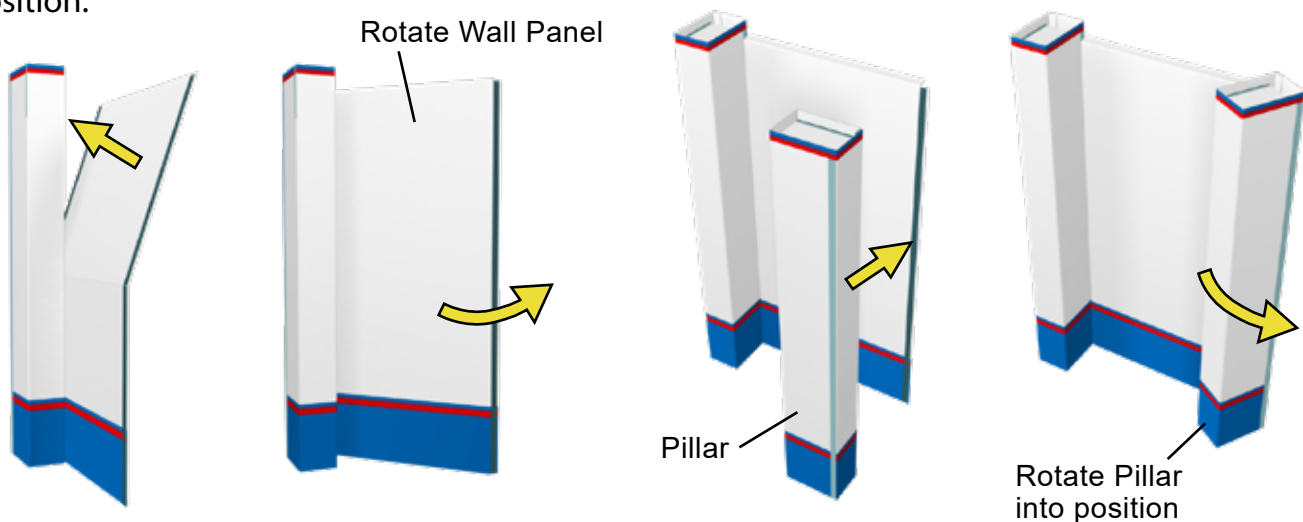

C) Repeat this process with the remaining Wall Panels and Pillars.

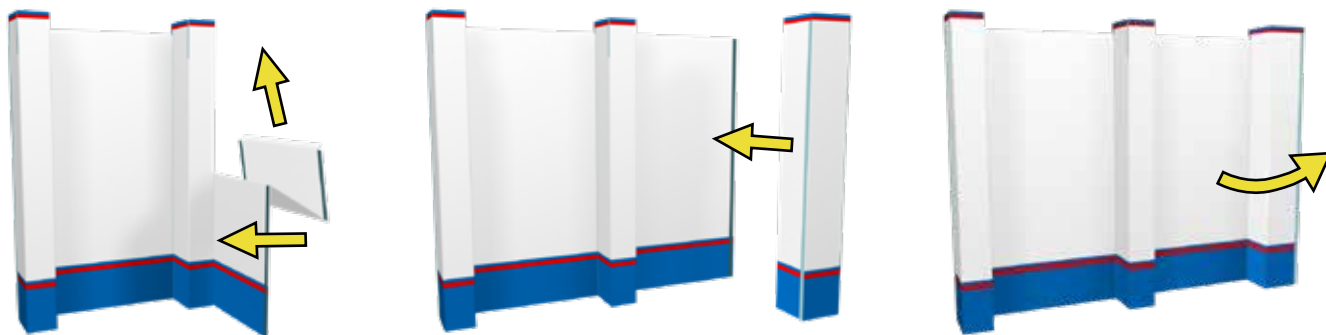

Attach Short Wall Panel to Pillars.

A) Unfold the Short Wall Panel, hold upright, and attach to Pillar with Velcro. (Make sure that the bottoms of the Pillar and Short Wall Panel are flat against the floor when attaching and that the accent stripes are aligned with each other.)

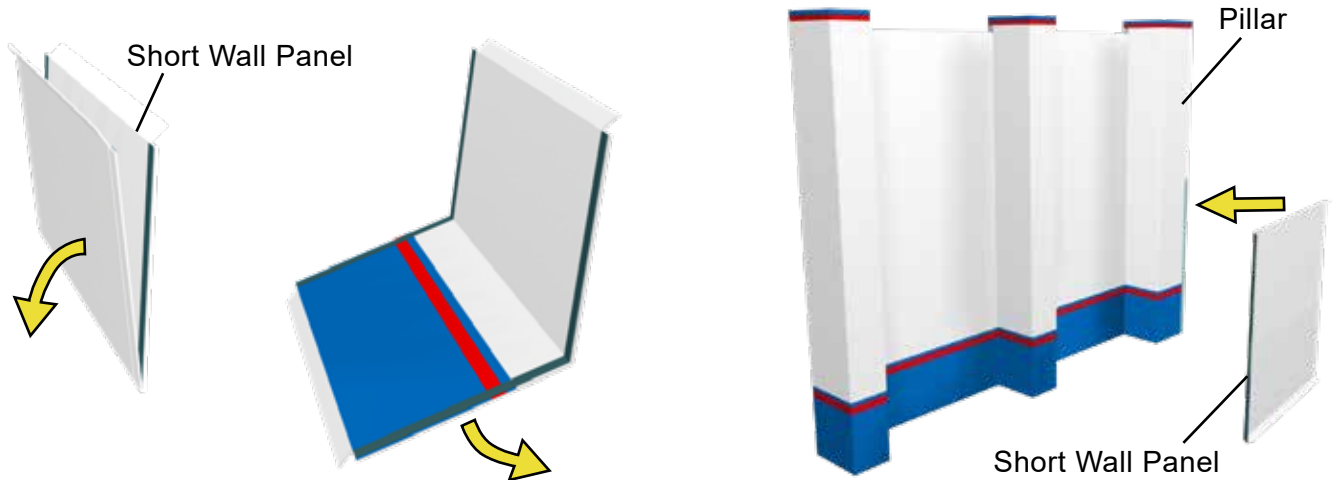

B) Rotate the Short Wall Panel into position. Attach the Short Pillar to the Short Wall Panel so that it is flat against the front face of the Short Wall Panel. Rotate the Pillar into position.

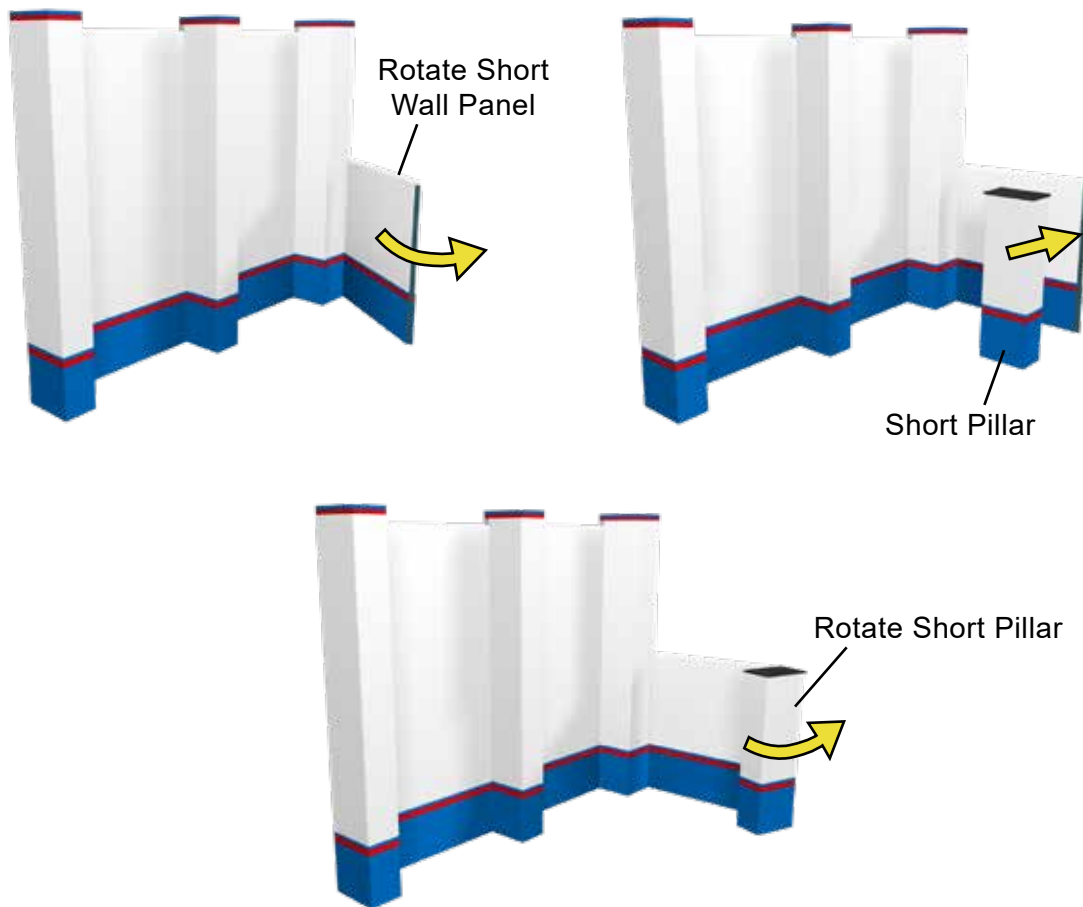

Attach the Fabric Graphics and posters to the Wall Panels with Velcro.

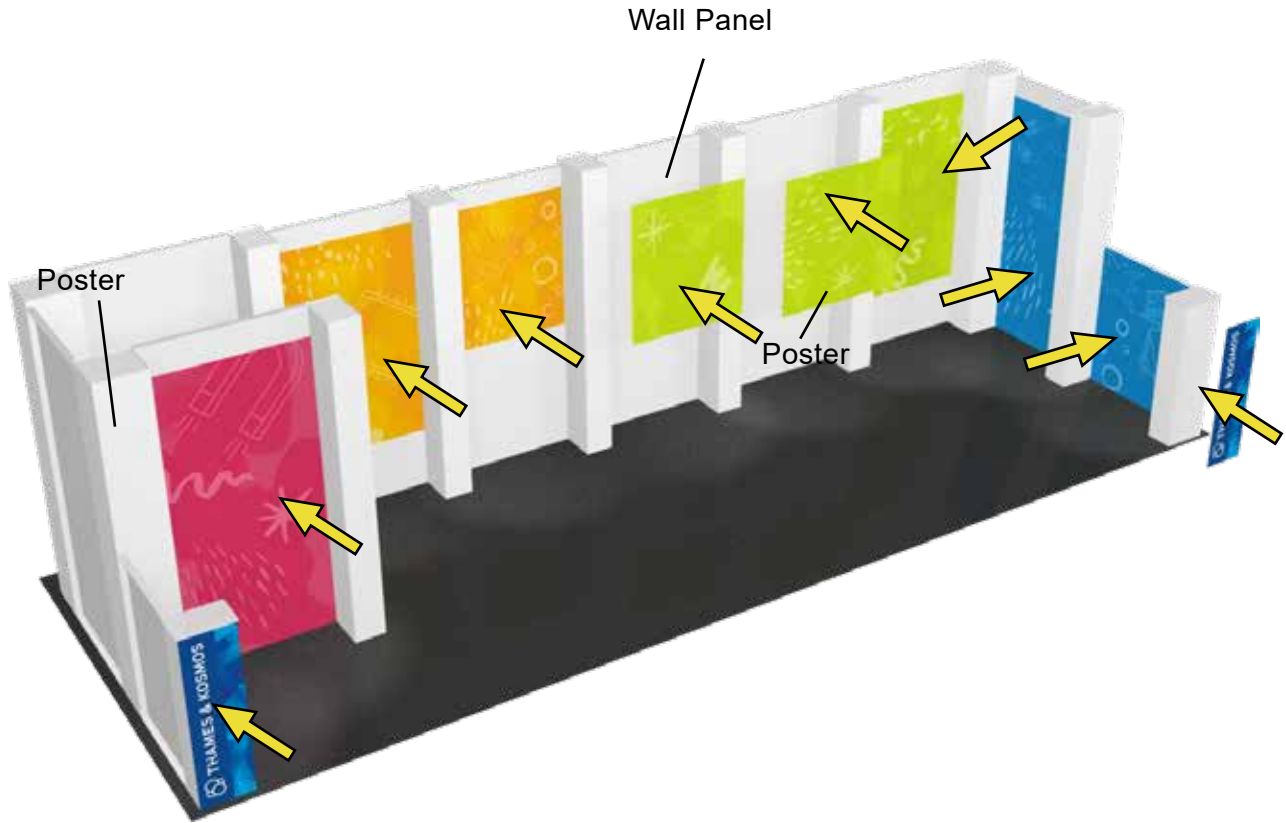

Assembly Instructions: InfiniLite 30-05

Install Shelf Support Bars.

A) Insert the shelf support bar into the designated openings in the Pillars.

Make sure that the Velcro on the bar is facing up to attach the shelf.

NOTE: Images on this page show typical installation of Shelf Support Bars, Storage Doors, and Shelves.

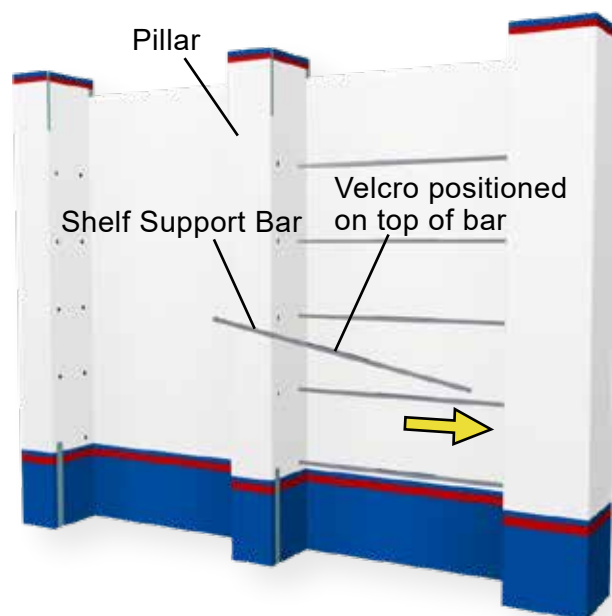

Install Storage Doors. (Attach Storage Doors to the inside of the Pillars with Velcro.)



Attach Shelves to Shelf Support Bars and top of Storage Doors with Velcro after the Fluorescent Lights have been installed. (See following pages for light installation.)

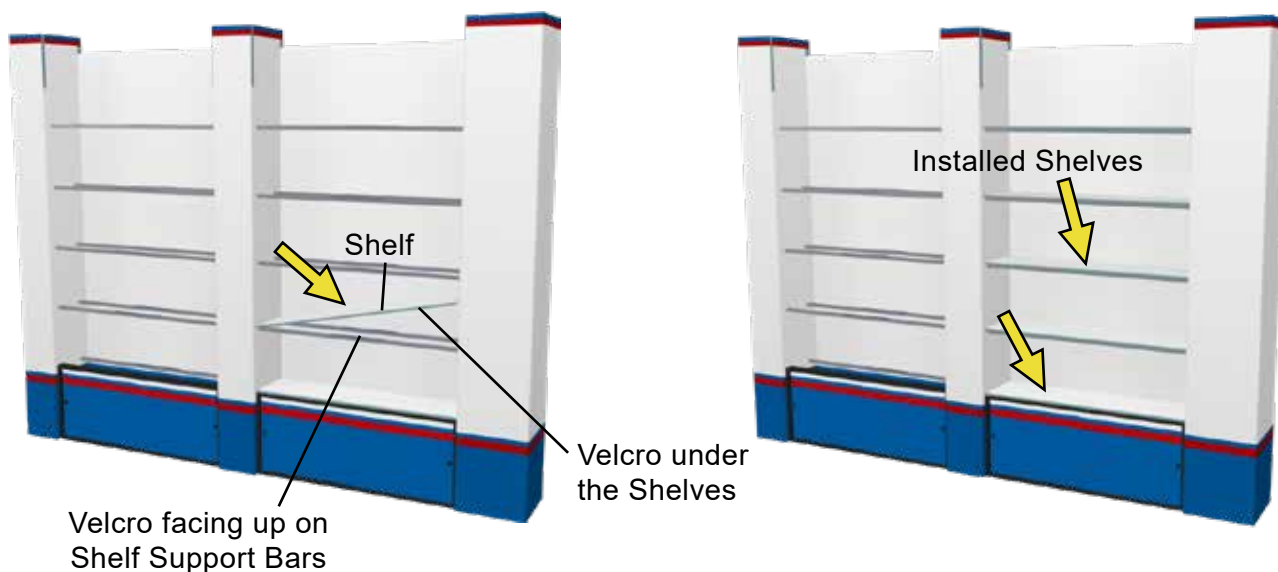

Assembly Instructions: InfiniLite 30-05

Assemble Signs and attach to Pillars with Velcro.

A) Unfold the Large Signs and Corner Signs. (The Small Signs are not folded in half.)



B) Fold down the top sections of the Sign along the flutes to form a triangle and Velcro closed.

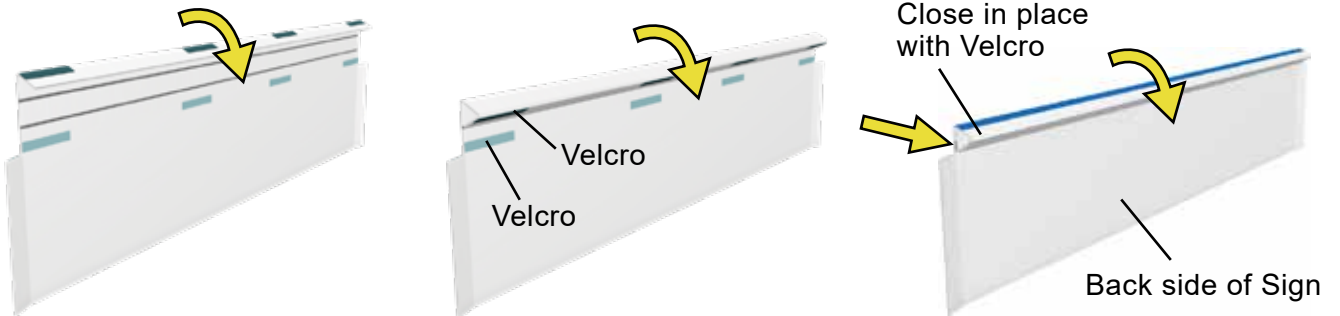

C) Attach Signs to Pillars with Velcro.

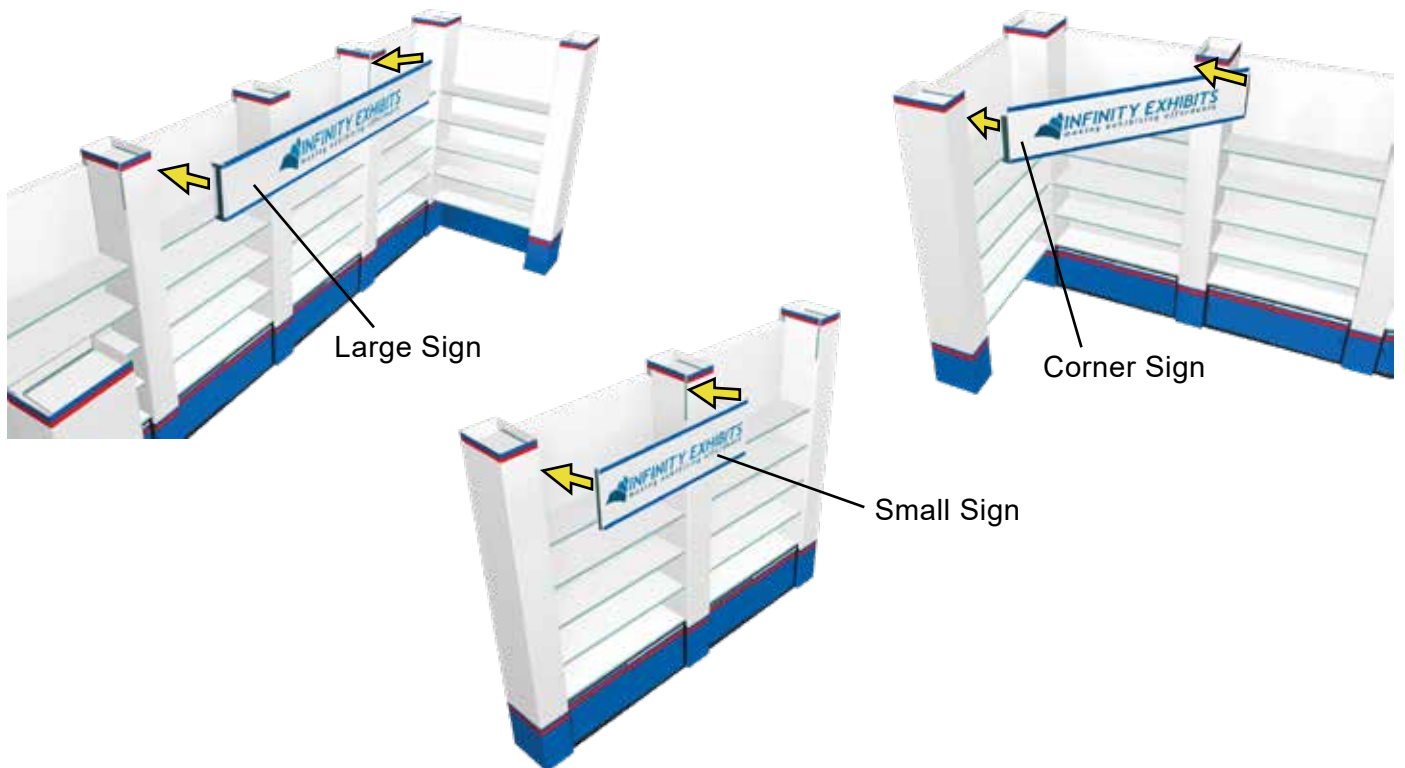

Install the Curtains along the inside of the Pillars.

A) Slide the Curtain and (2) Rubber Stoppers onto the Hanging Bar. Insert the Hanging Bar into the specified openings in the sides of the Pillars. Push the rubber stoppers against the Pillars. One stopper should be at each end of the bar to keep the bar securely in place.

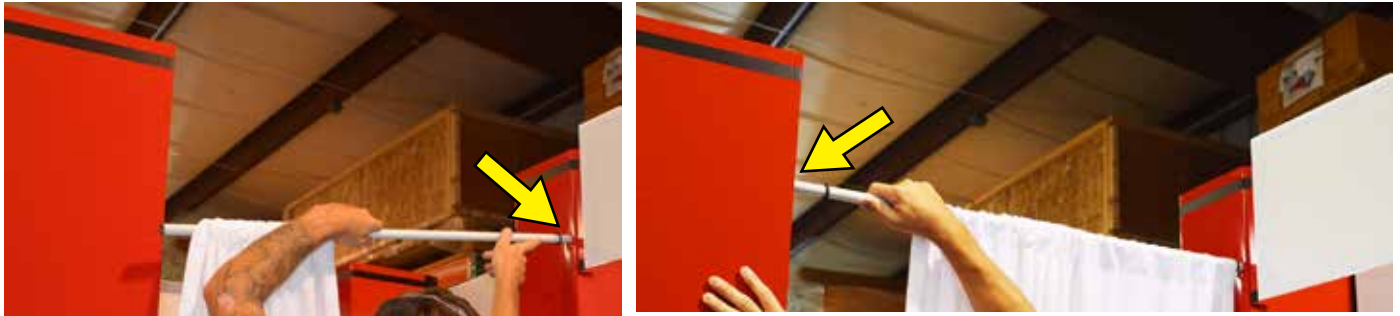

B) Additional Rubber Stoppers may be placed on the Hanging Bar from within the Pillars to further secure the Hanging Bar in place.

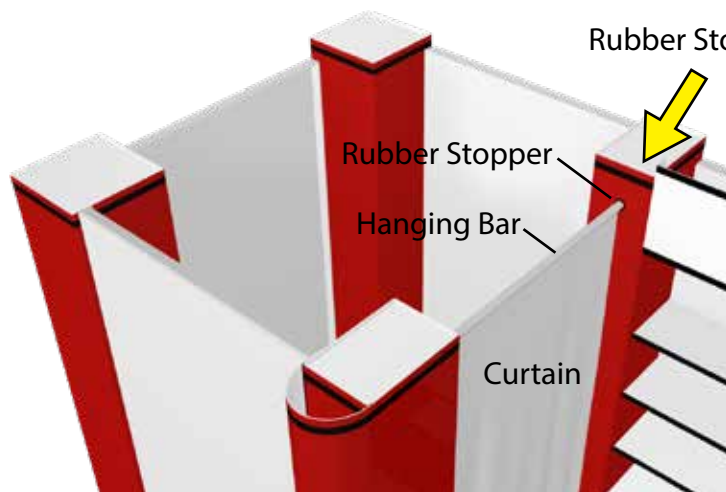

View showing installed Curtain.



Attach the Stem Lights to the tops of the Pillars.

A) Place a wooden Light Support Stick on top of the proper Pillars as shown. (Use a ladder or step stool to access the top of the Pillar.) Secure the Stick to the back of the Pillar with a Binder Clip.

B) Attach the Stem Light to the front end of the Pillar and Support Stick by adjusting the thumbscrew on the back of the Stem Light. (DO NOT overtighten the thumbscrew. Overtightening the adjustment thumbscrew may damage the Pillar.)

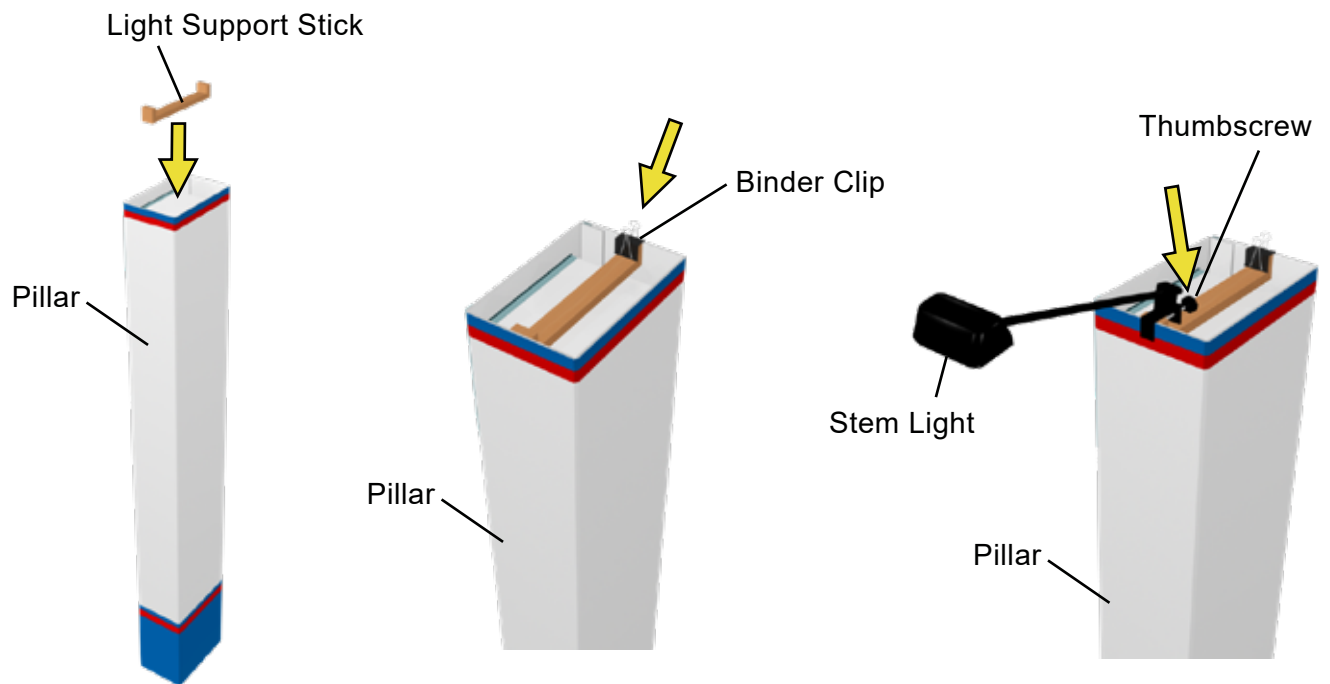

Assembly Instructions: **InfiniLite 30-05**

Attach the Pillar Covers to the Pillars with Velcro.

A) Some Configurations will require a cover panel to hide unused shelf support holes

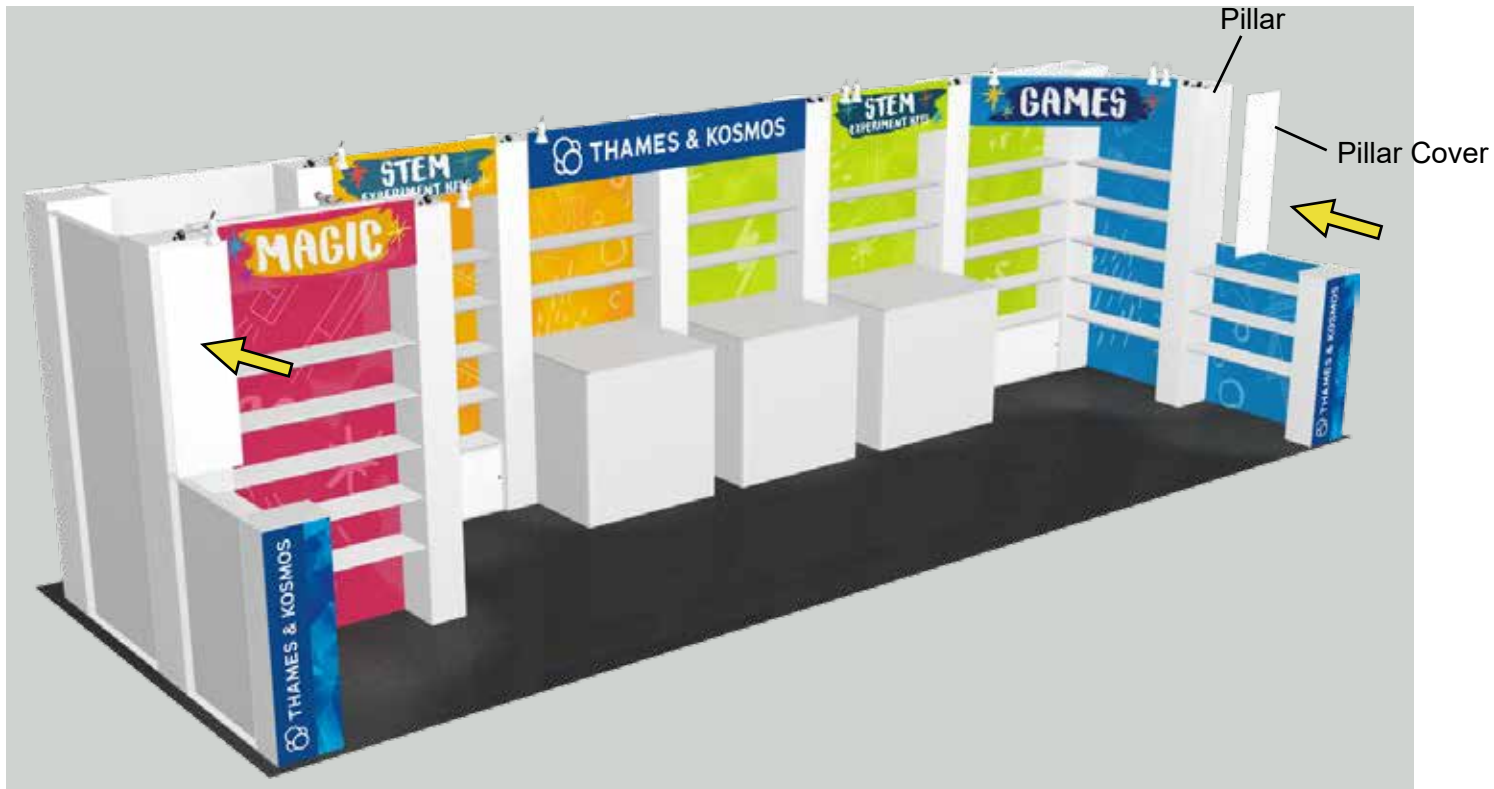

Counter Assembly Instructions

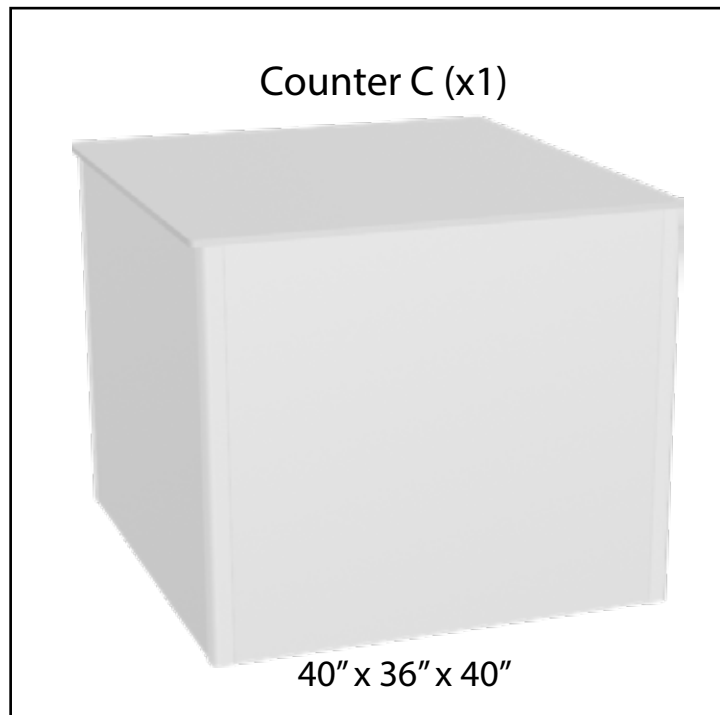
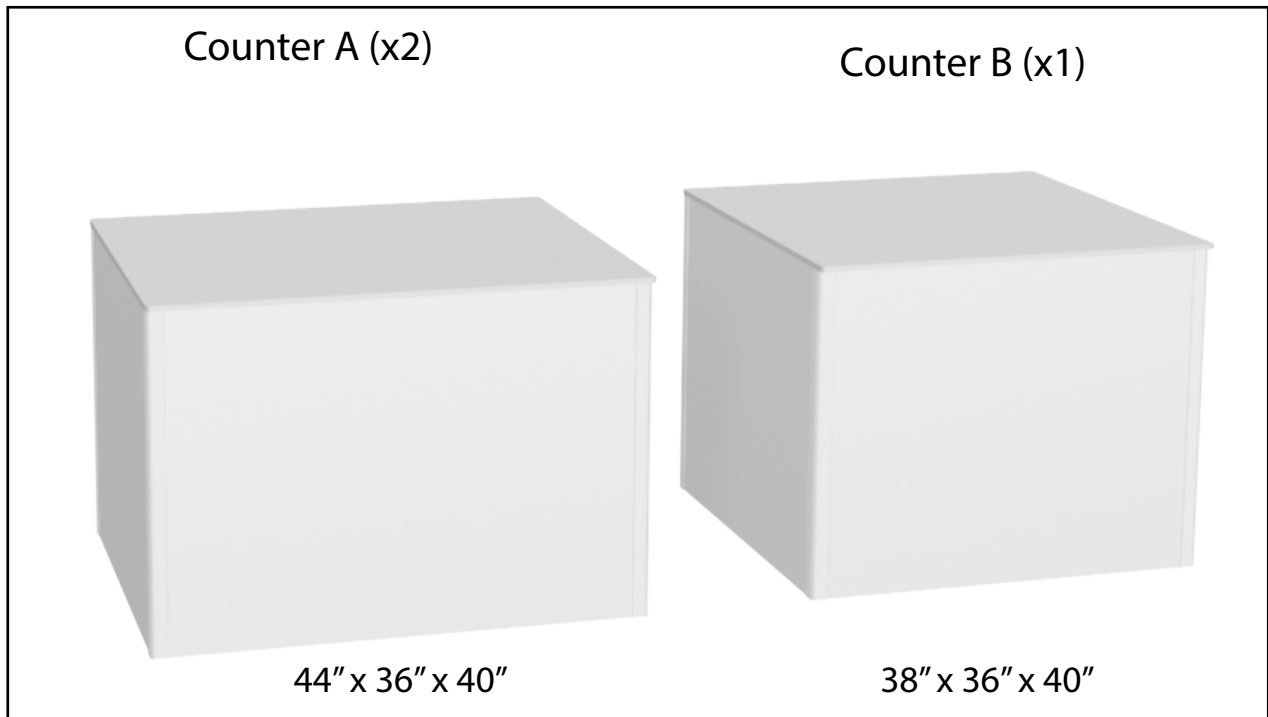

Counter A - Assembly:

A) Connect the Counter Panels together with the 90° Channels. (Make sure that the Velcro is oriented along the top of the Panels for attaching the Counter Top.)

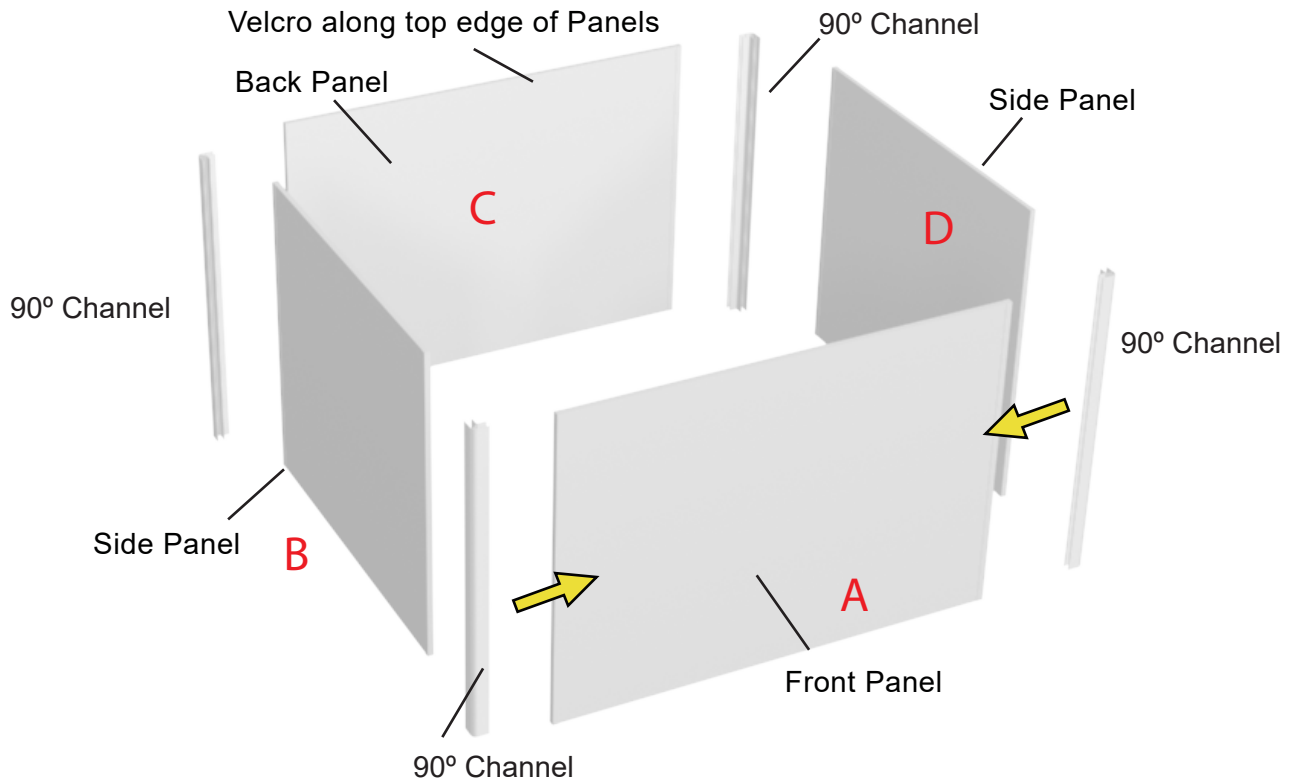

B) Attach the Counter Top to the tops of the Panels with Velcro.

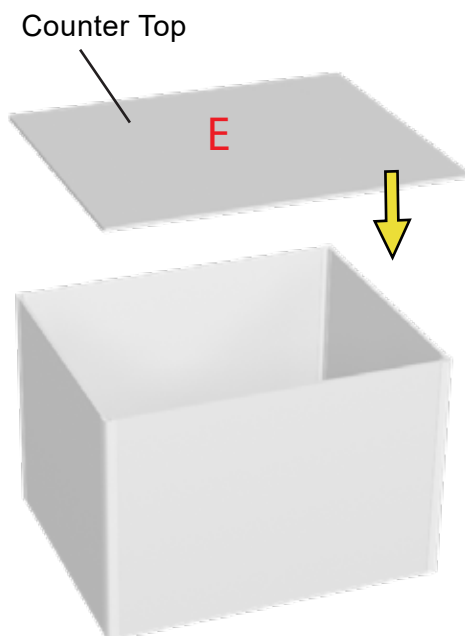

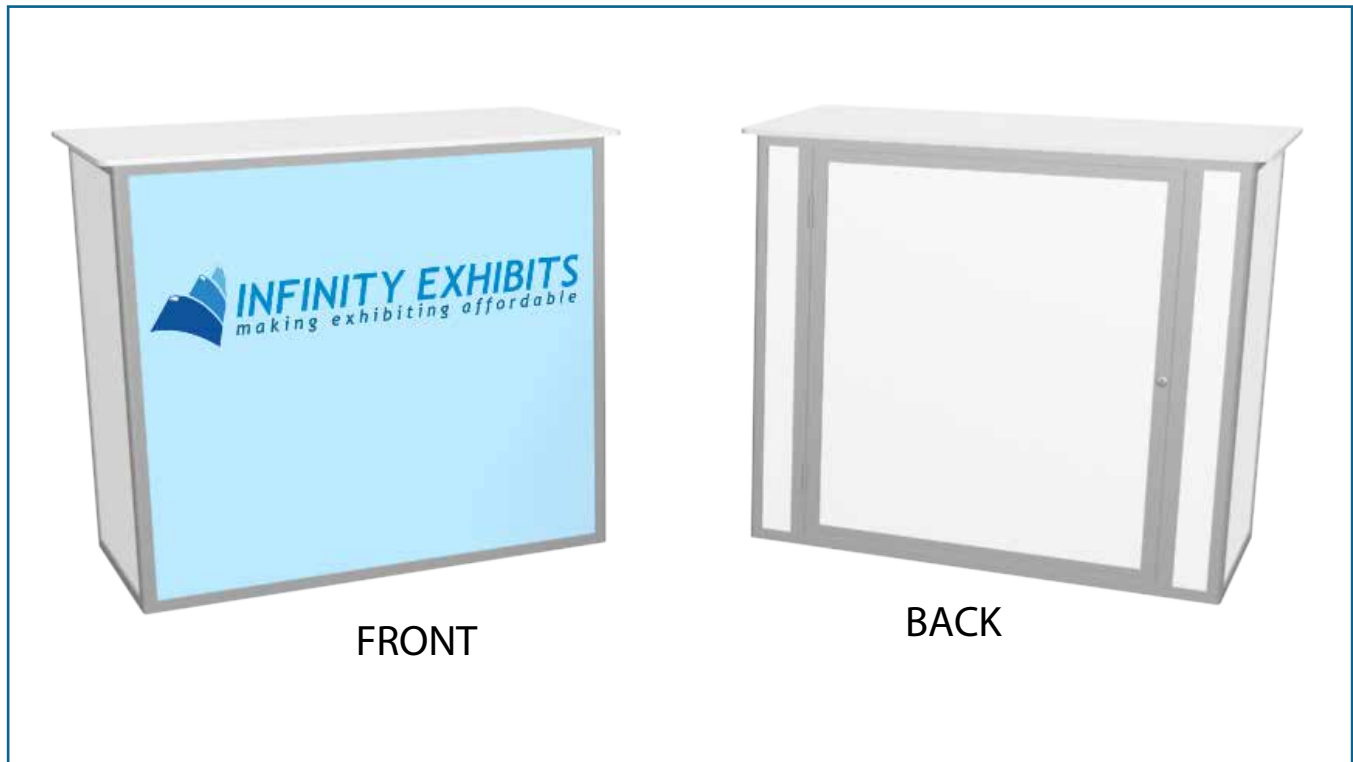

Steps to Assemble the Locking Counter with Shelf:

- Step 1: Attach the Bottom Braces to the Front and Back Panel Assemblies.
- Step 2: Slide one of the Side Panels into the frame.
- Step 3: Place Shelf onto Shelf Brackets.
- Step 4: Slide the second Side Panel into the frame.
- Step 5: Attach Top Braces to Front and Back Panels.
- Step 6: Attach Counter Top to frame with Velcro.
- Step 7: Attach Poster(s) to the Counter with Velcro.

Assembly Instructions: InfiniLite 30-05

Step 1: Attach the Bottom Braces to the Front and Back Panel Assemblies with the Tension Locks and hex key.

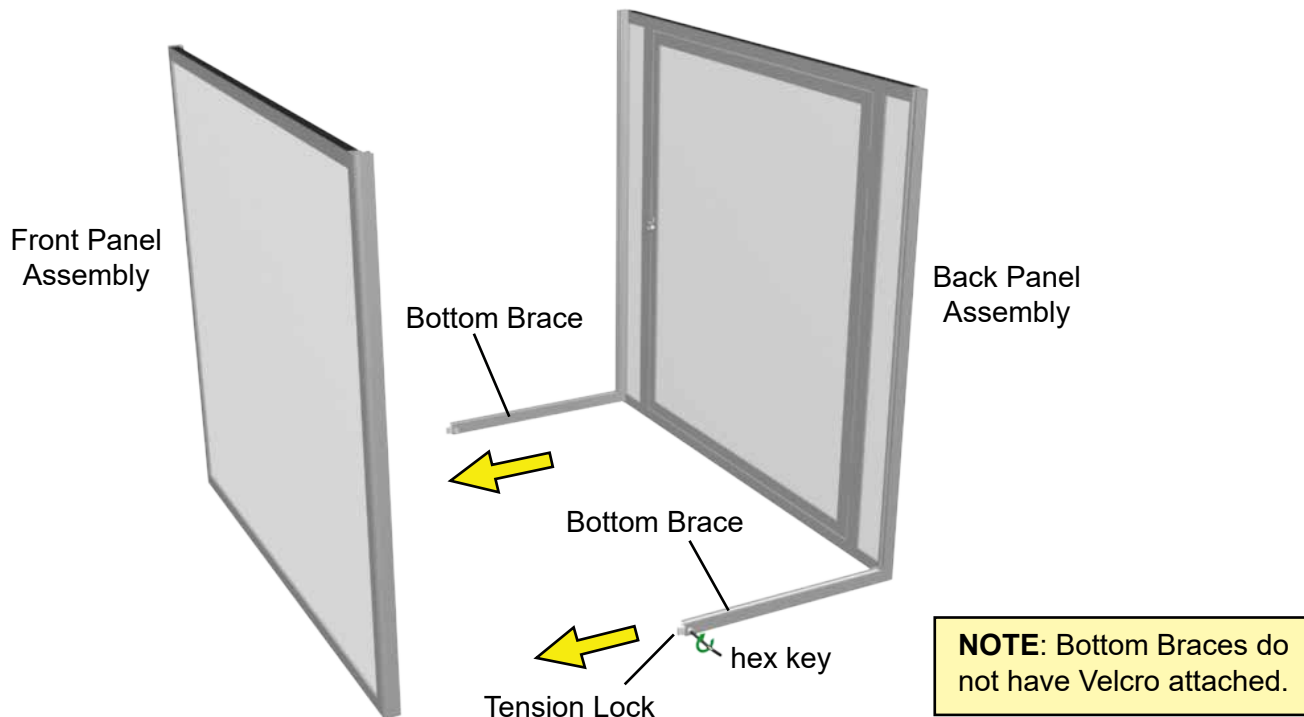

Step 2: Slide one of the Side Panels into the frame.

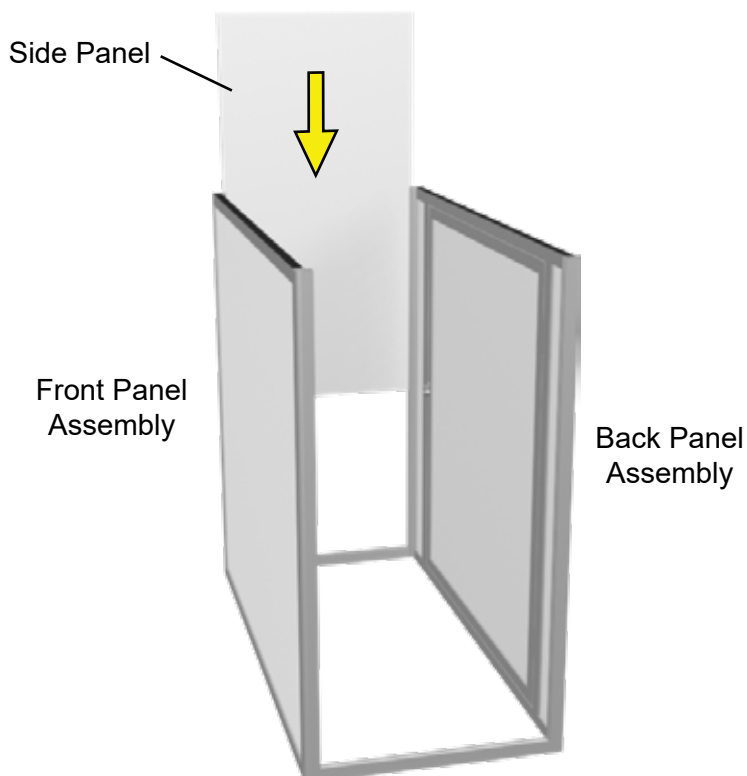

Step 3: Place the Shelf onto the Shelf Brackets. (Attach the Shelf Brackets along the interior tracks of the Front and Back Panel Assemblies if they are not already attached. Also, adjust the heights of the Shelf Brackets as desired.)

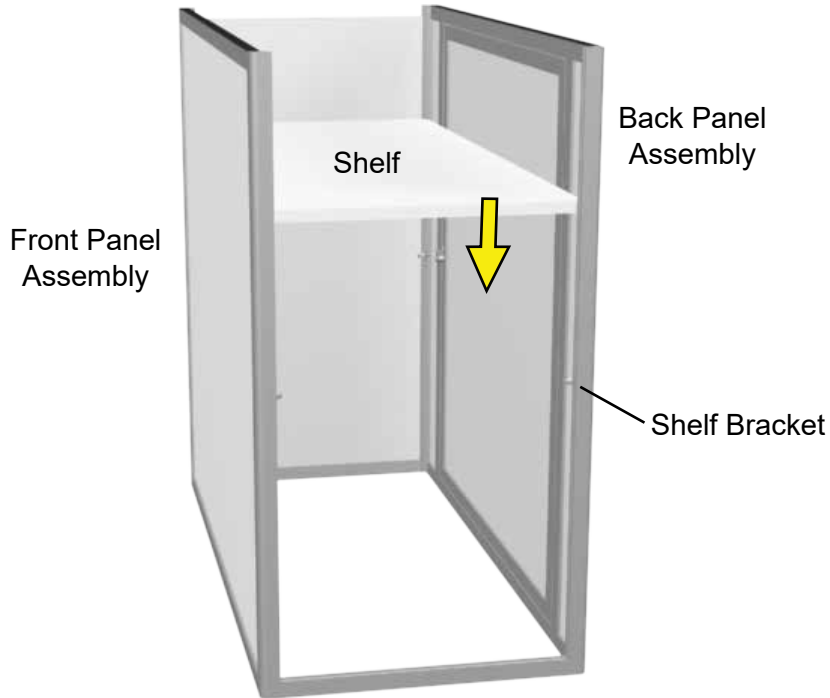

View showing Shelf Bracket installed along track.

Step 4: Slide the second Side Panel into the frame.

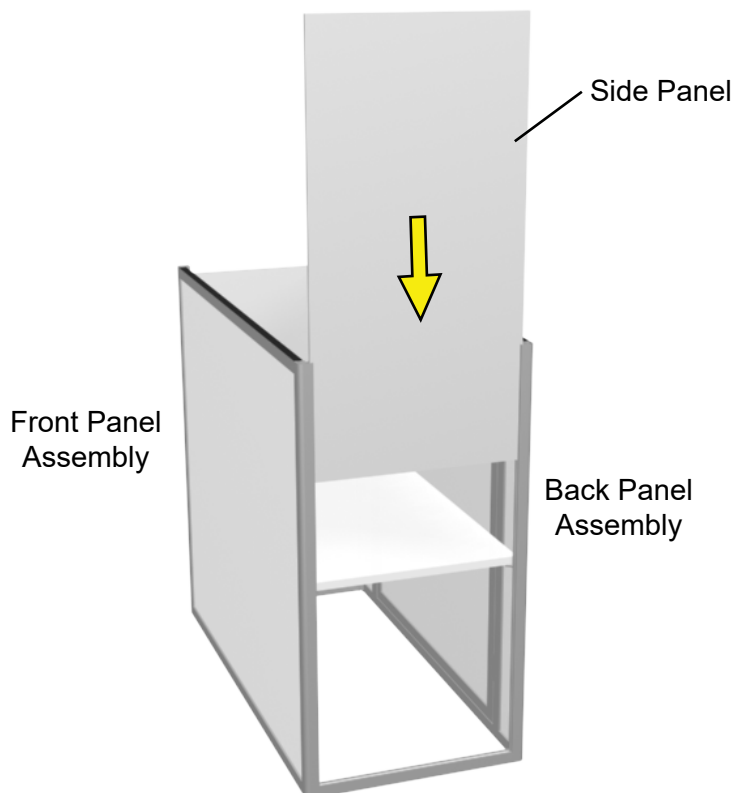

Assembly Instructions: InfiniLite 30-05

Step 5: Attach the Top Braces to the frame.

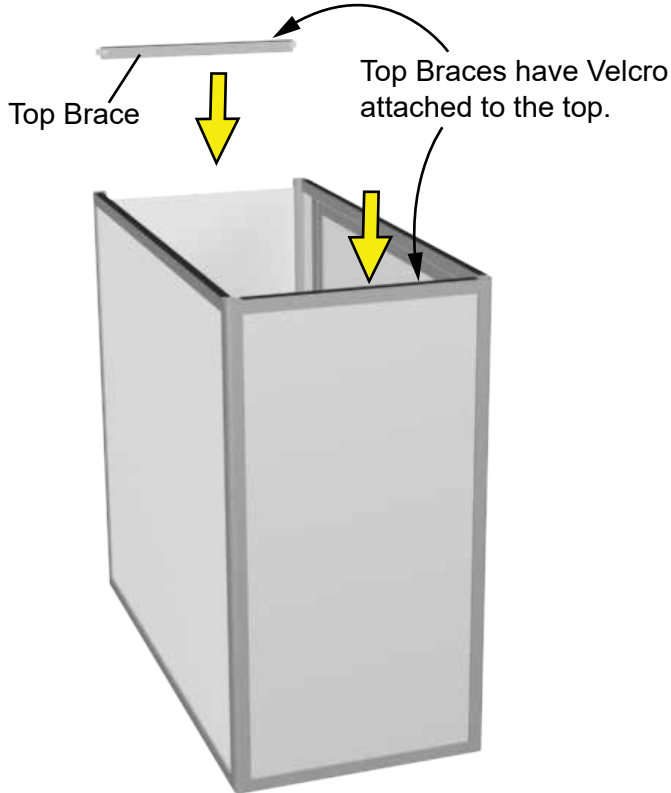

Secure the Top Braces with hex key and Tension Locks.

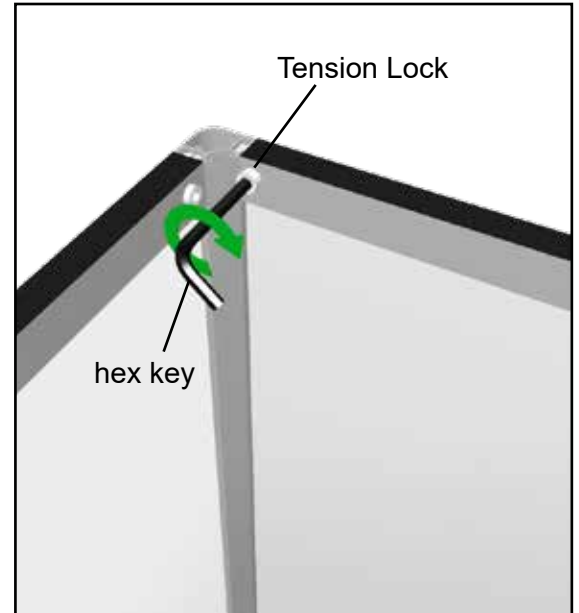

Step 6: Attach Counter Top to frame with Velcro.

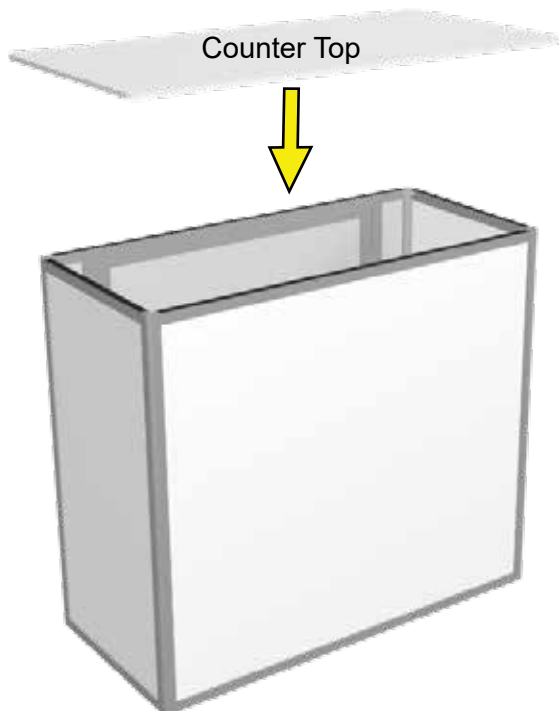

Step 7: Attach Poster to the front of the Counter with Velcro.

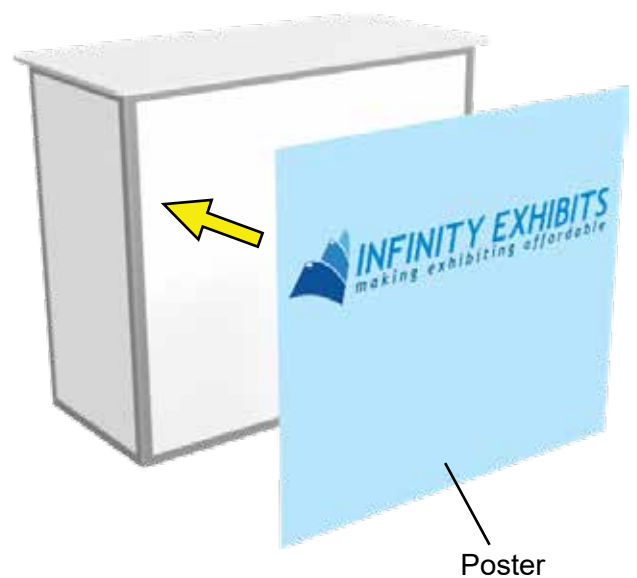

Tub Layout

Disassemble the booth components and pack them into the (2) shipping tubs and (1) case:



Shipping Tubs (x2)



Shipping Case (x1)

Tub

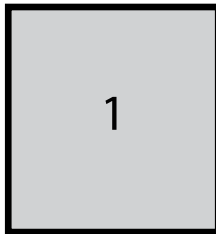

Booth Components

- 1) Pillars
- 2) Pillar Supports
- 3) Wall Panels
- 4) Signs
- 5) Shelves
- 6) Shelf Support Bars
- 7) Sliding Storages

NOTE: Pack the heavier components toward the bottom of the Tubs.

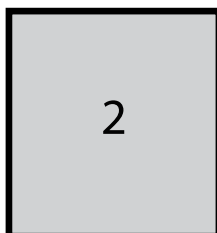

- 1) Pedestal Panels
- 2) Pedestal Tops
- 3) Counter Components
- 4) Counter Tops
- 5) Curtain Rod



View showing booth packed in shipping tubs and shipping case.

Case

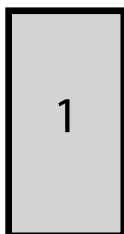

- 1) Prints
- 2) Lights
- 3) Light Supports
- 4) Power Cords
- 5) Curtain