



Display Setup Instructions



10' x 30' Display Booth



20' x 20' Display Booth



Steps to Assemble the InfiniLite Multi Section Exhibit Booth:

- Step 1:** Assemble the Soft Foam Flooring within the booth area.
- Step 2:** Assemble Pillars and Corner Pillars.
- Step 3:** Place Pillars upright in their proper order.
- Step 4:** Attach Wall Panels to Pillars.
- Step 5:** Install Storage Doors.
- Step 6:** Install Shelf Support Bars and Light Bars behind Signs.
- Step 7:** Attach Fluorescent Lights to Bars and connect in series.
- Step 8:** Attach Shelves to Shelf Support Bars with Velcro.
- Step 9:** Attach Fabric Graphic to middle Wall Panels and Center Pillar with Velcro.
- Step 10:** Attach Signs to Pillars with Velcro.
- Step 11:** Attach Stem Lights to top of Pillars

Assembly Instructions: InfiniLite 30-04

Assemble the Pillars.

A) Unfold the Pillar Panels with the front sides facing downward.

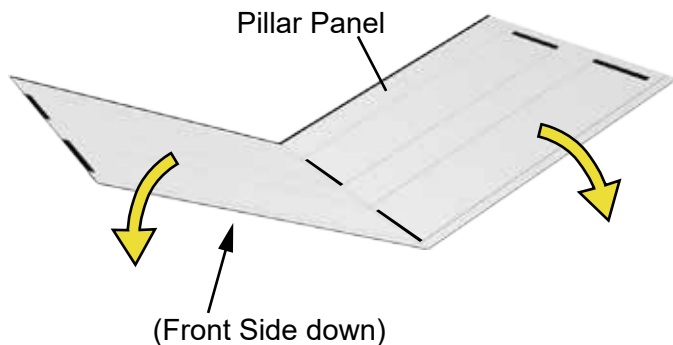

B) Attach the Top, Middle and Bottom Supports to the back of the Pillars with Velcro.

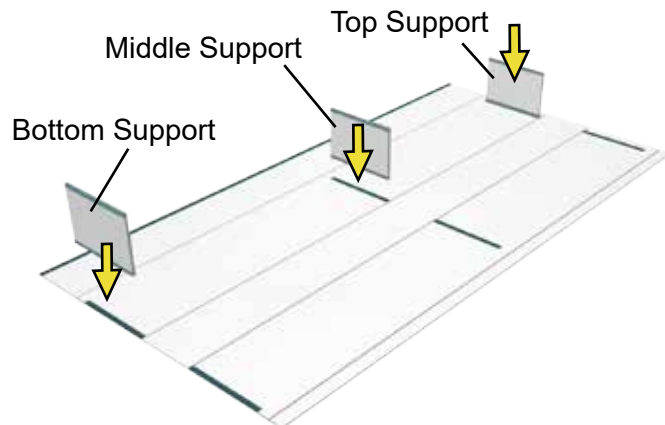

C) Fold Pillar around the Supports and attach with Velcro.

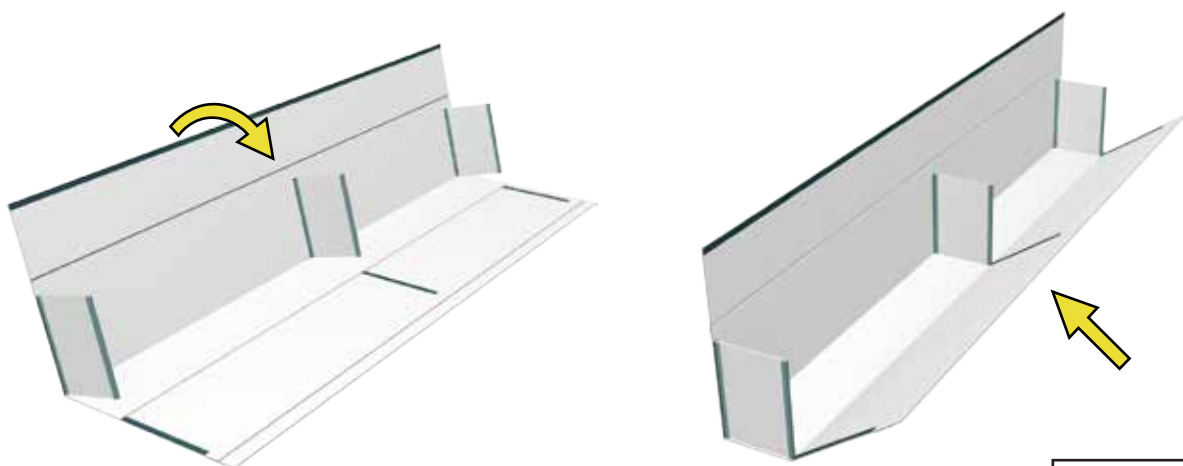

D) Close the Pillar using the Velcro strips along the Pillar edges.

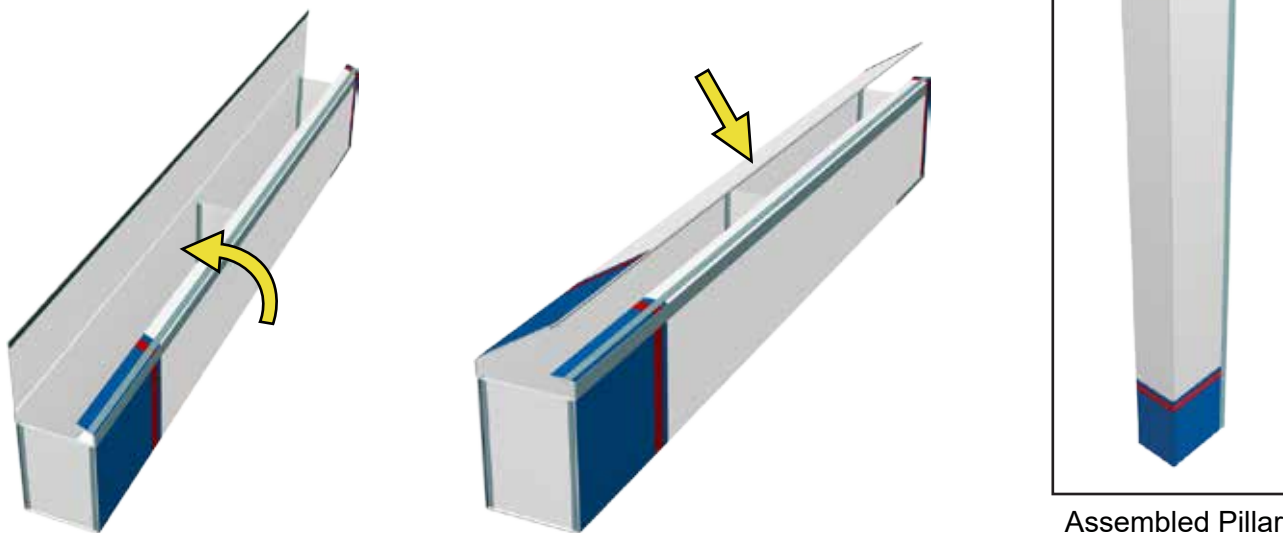

Assembly Instructions: InfiniLite 30-04

A) Unfold the Corner Pillar Panels with the front sides facing downward.

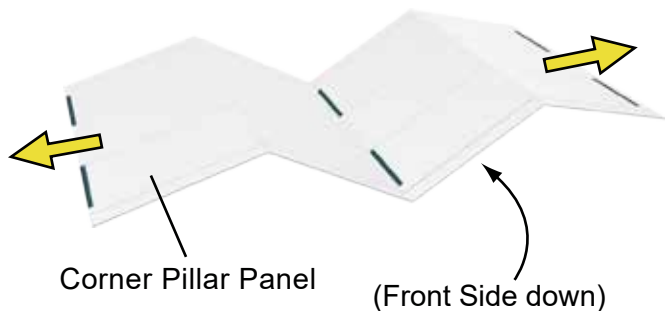

B) Attach the Top, Middle and Bottom Supports to the back of the Corner Pillars with Velcro.

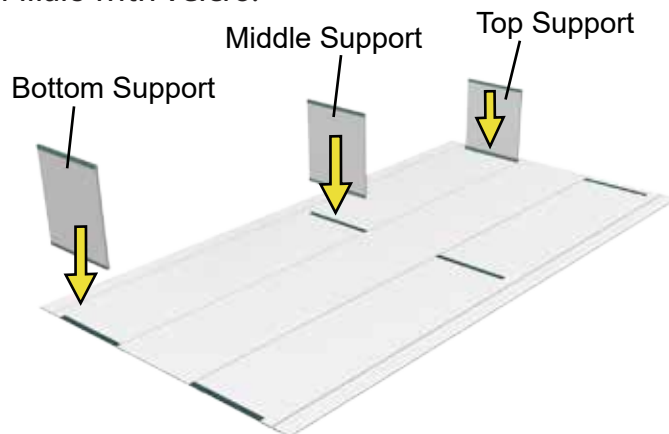

C) Fold the Corner Pillar around the Supports and attach with Velcro.

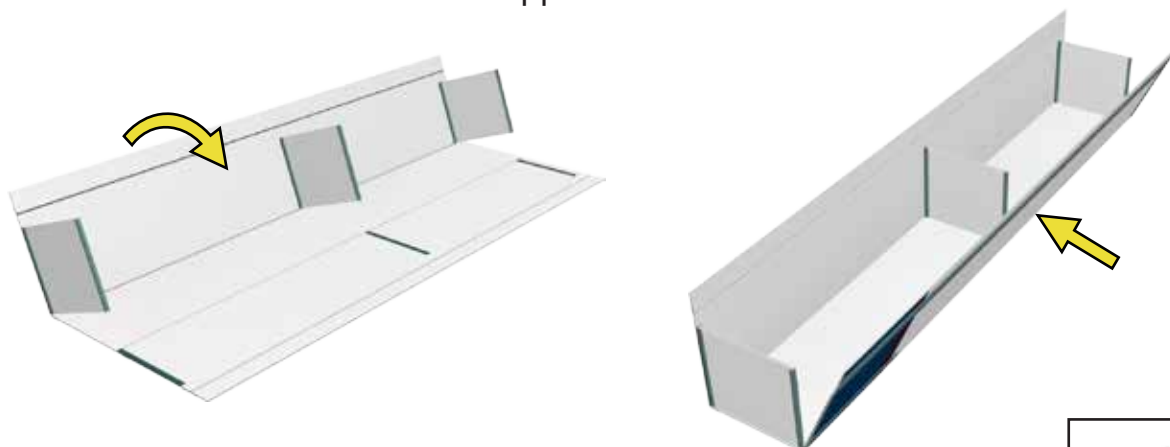

D) Attach the Back Cover to the bottom half of the Corner Pillar with Velcro; unfold the Back Cover; then attach the remaining Back Cover to the upper half of the Corner Pillar.

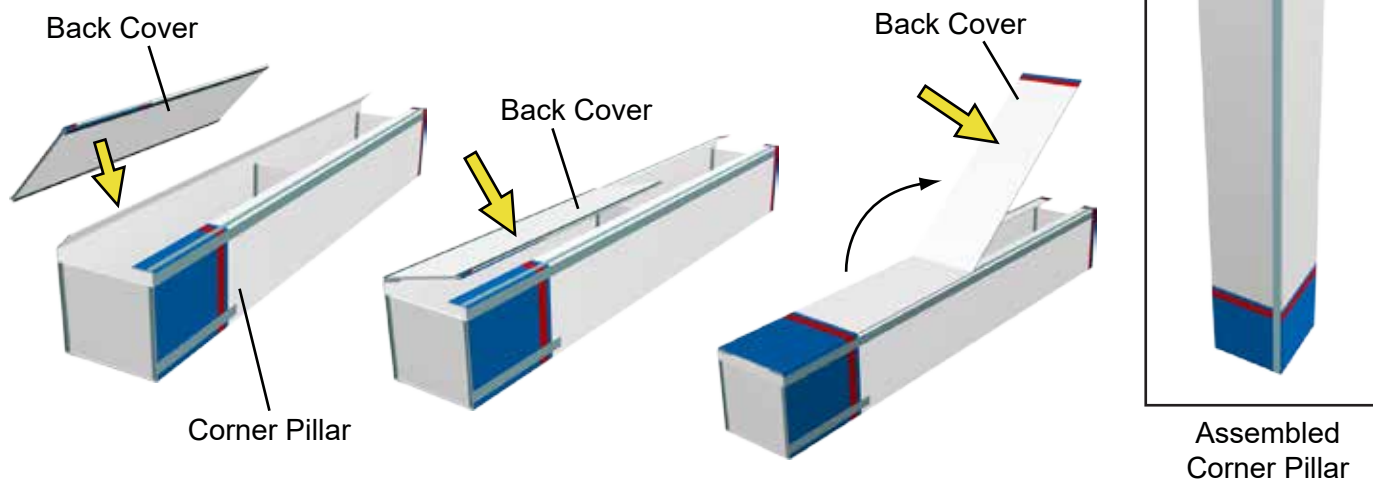

Assembly Instructions: InfiniLite 30-04

The following Floor Plan identifies the locations of the 10'x30' Booth Components:

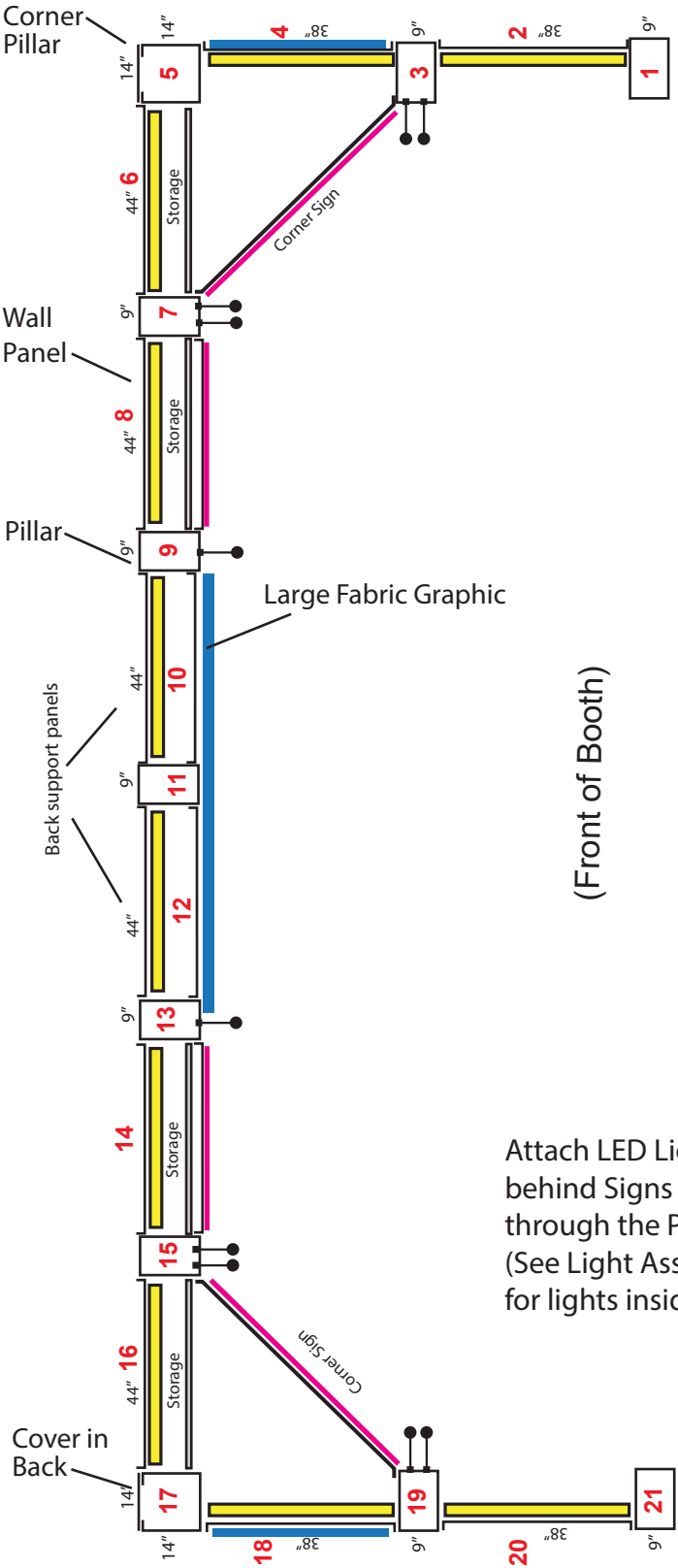

TOP VIEW
Floor Plan: 10'x30'

LEGEND

	Storage Doors
	Printed Poster
	Fabric Print
	LED Shelf Light
	Stem Light

(Front of Booth)

Attach LED Lights to shelf support bars beneath Shelves and behind Signs with Velcro and with power cords threaded through the Pillars. Connect lights in series with Link Cables. (See Light Assembly pages for details.) Connect Power Supply for lights inside Pillars 5 & 17.

Assembly Instructions: InfiniLite 30-04

Alternate Booth Assembly (20'x20').

- A) The 10'x30' Display Booth can be assembled as a 20'x20' Display.
- B) The following Floor Plan identifies the locations of the 20'x20' Booth Components.

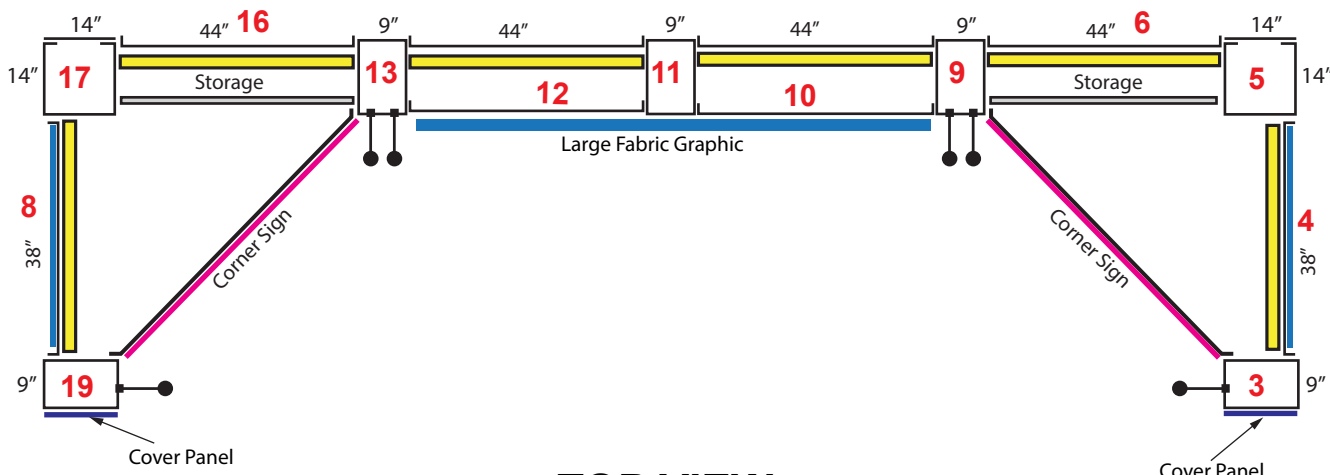

TOP VIEW
Floor Plan: 20'x20'

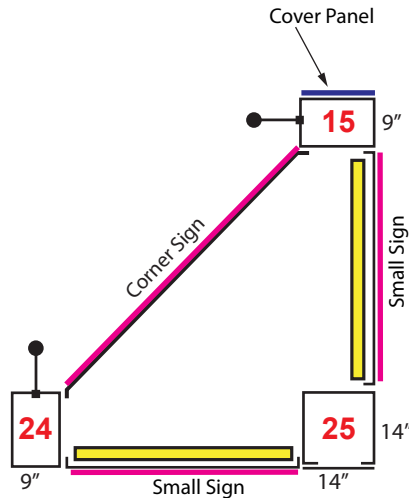
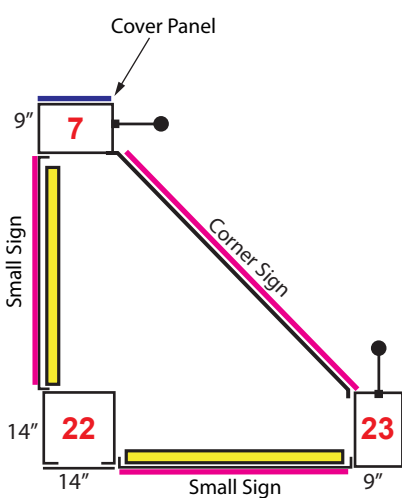

LEGEND

	Storage Doors
	Fabric Print
	Printed Poster
	LED Shelf Light
	Stem Light

Attach LED Lights to shelf support bars beneath Shelves and behind Signs with Velcro and with power cords threaded through the Pillars. Connect lamps in series with Link Cables. (See Lamp Assembly pages for details.) Connect Power Supply for lamps inside Pillars 5, 17, 22, & 25.

Assembly Instructions: InfiniLite 30-04

Place the assembled Pillars and Corner Pillars upright in their proper order and assigned locations as numbered and indicated on the Floor Plan.

TOP VIEW
Floor Plan: 10'x30'

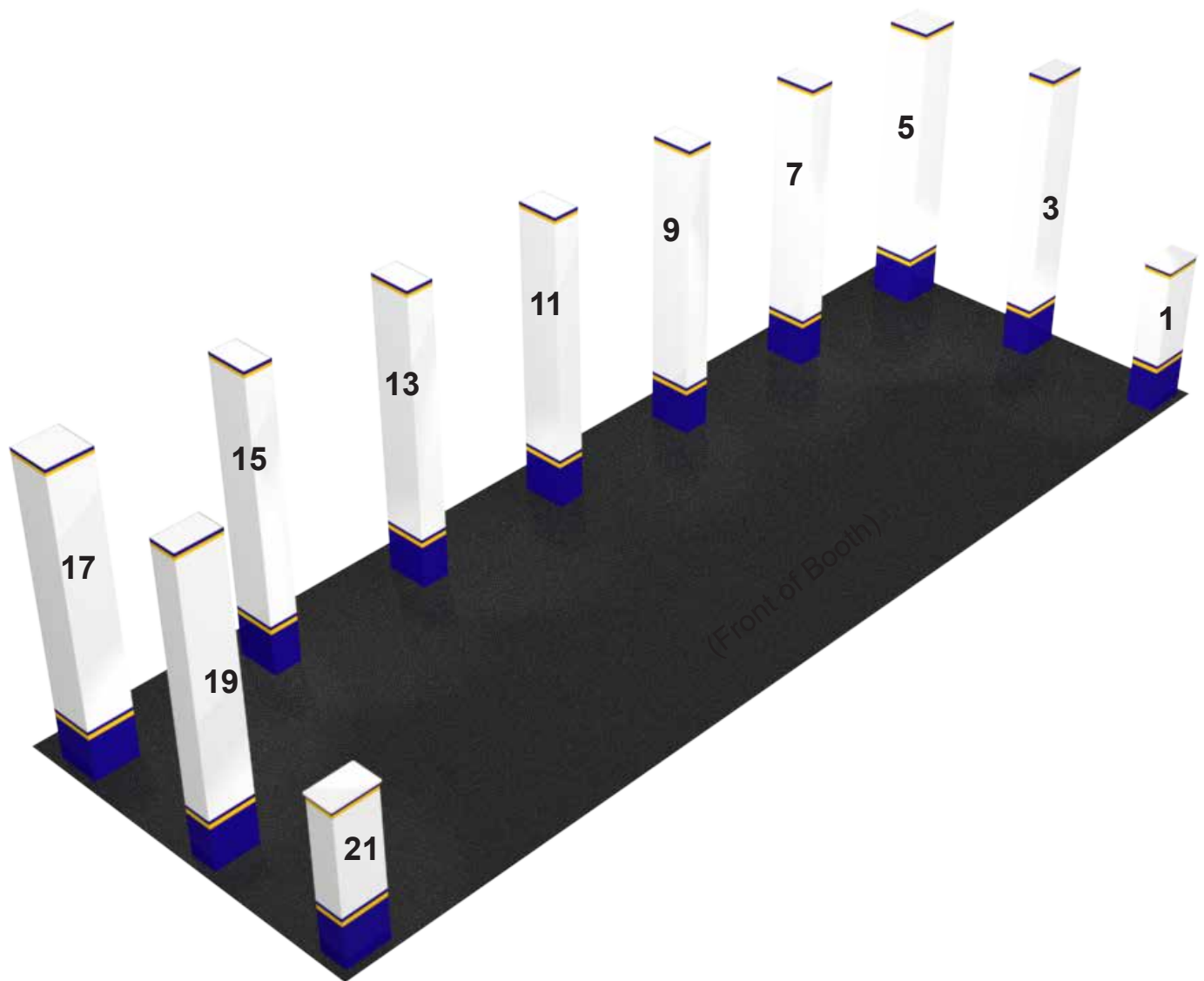

Assembly Instructions: InfiniLite 30-04

Place the assembled Pillars and Corner Pillars upright in their proper order and assigned locations as numbered and indicated on the Floor Plan.

TOP VIEW

Floor Plan: 20'x20'

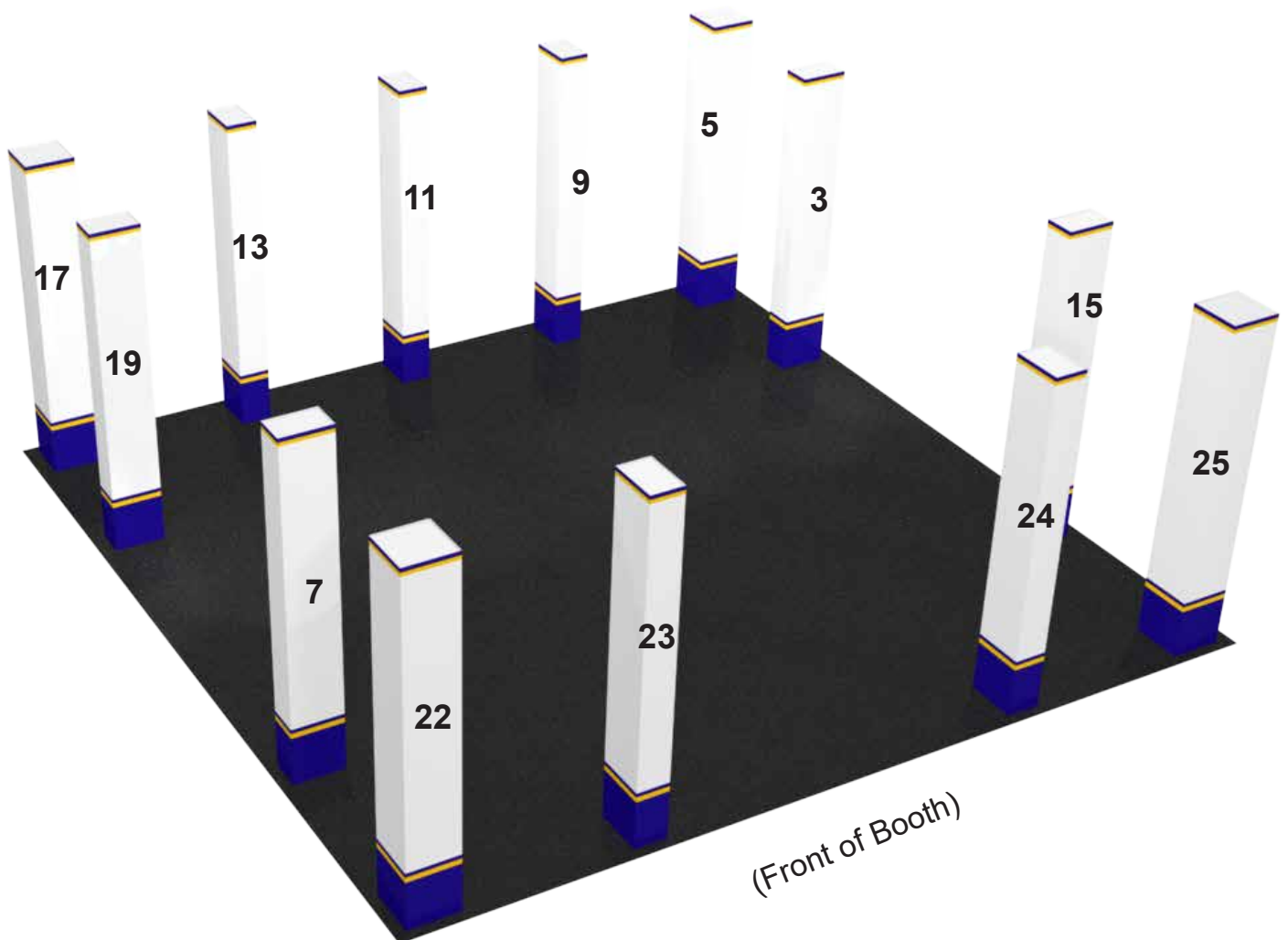

Assembly Instructions: InfiniLite 30-04

Attach Wall Panels to Pillars.

A) Unfold the bottom half of the Wall Panel, hold upright and attach to the side of the Pillar with Velcro. (Make sure that the Pillar and Wall Panel are **flat** on the floor surface when attaching and that the accent stripes are aligned with each other.) Begin assembly from either the left or right side of the Booth.

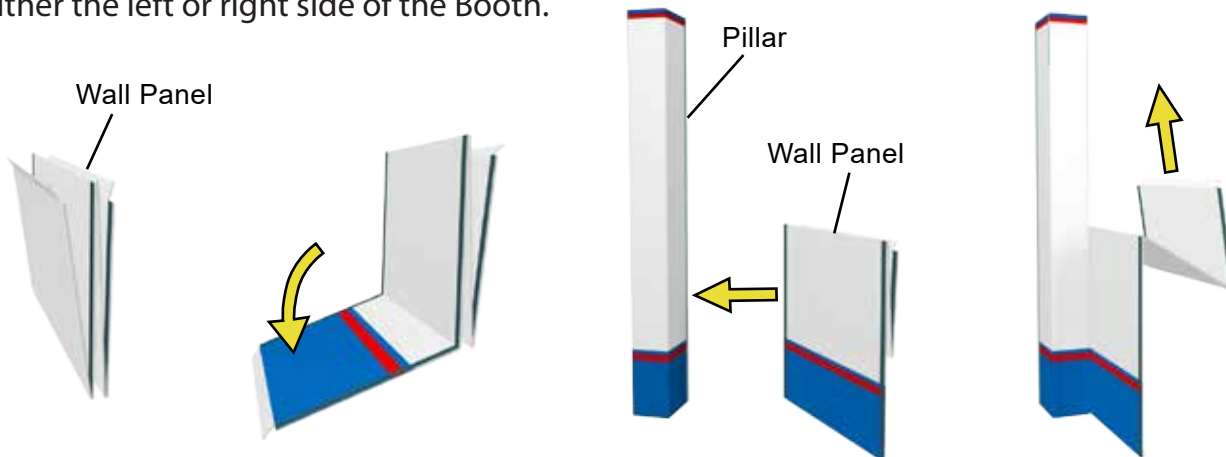

B) Unfold the top half of the Wall Panel and attach it to the top half of the Pillar matching the Velcro strips along the edges. Rotate the Wall Panel into position. Attach the next Pillar to the Wall Panel so that it is flat against the front face of the Wall Panel. Rotate the Pillar into position.

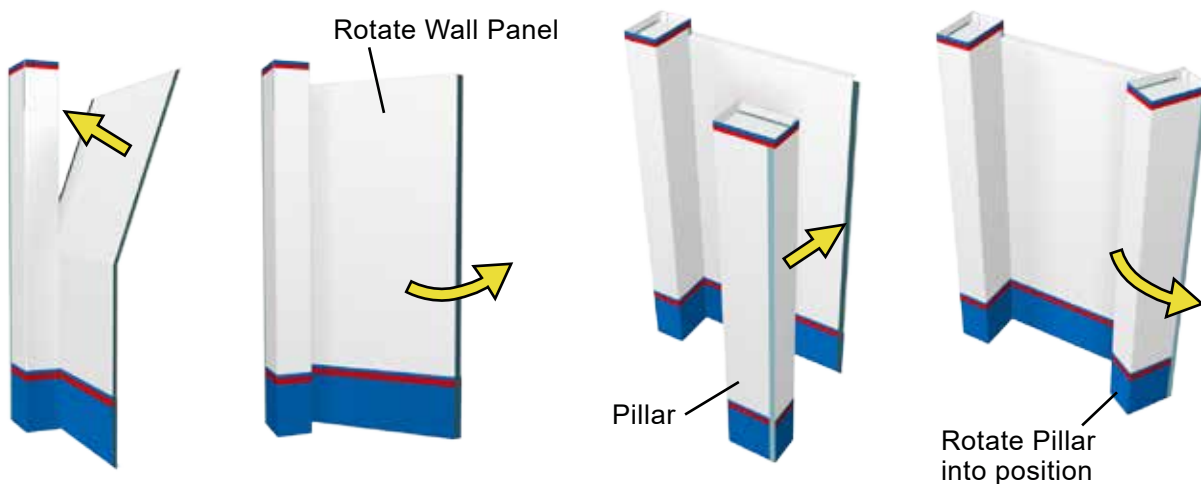

C) Repeat this process with the remaining Wall Panels and Pillars.



NOTE: Wall panel # 10, and 12, attach to the Front of the Pillars. (As seen in rendering [page 7.](#))

Assembly Instructions: InfiniLite 30-04

D) Sections 10 and 12 have Wall Panels that are reinforced in back with Support Sticks at the top and backwall supports at the bottom.

Attach the Support Sticks to the top of the backwall Wall Panels with Velcro.

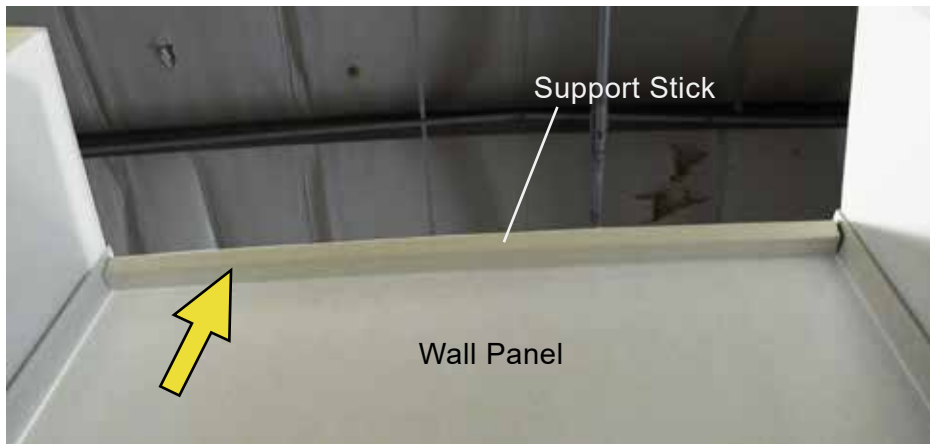

Support Stick attached to top of Wall Panel.

Attach the Backwall Supports to back of Pillars at the bottom with Velcro.

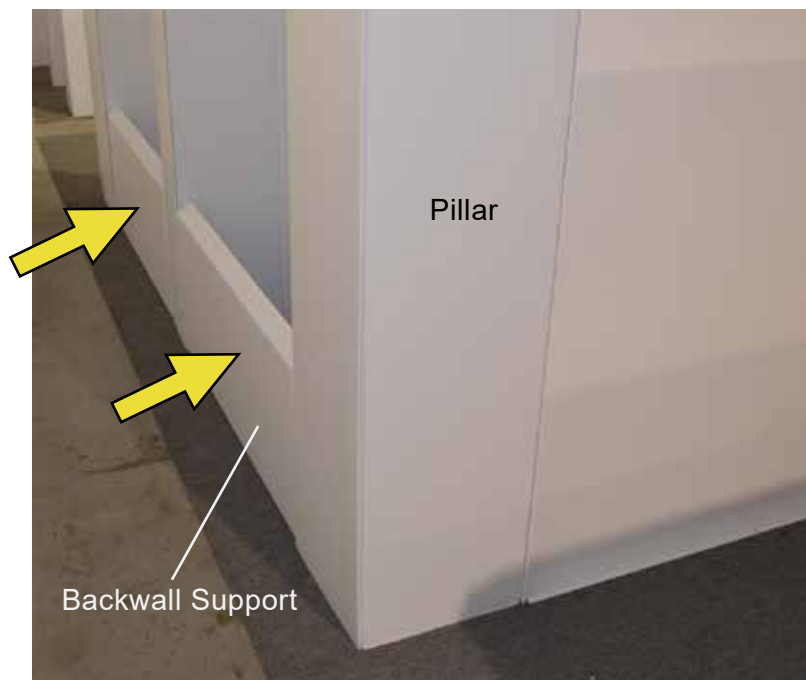

Backwall Supports aid to stabilize the booth.

Assembly Instructions: InfiniLite 30-04

Install Storage Doors. (Attach Storage Doors to Pillars with Velcro.)

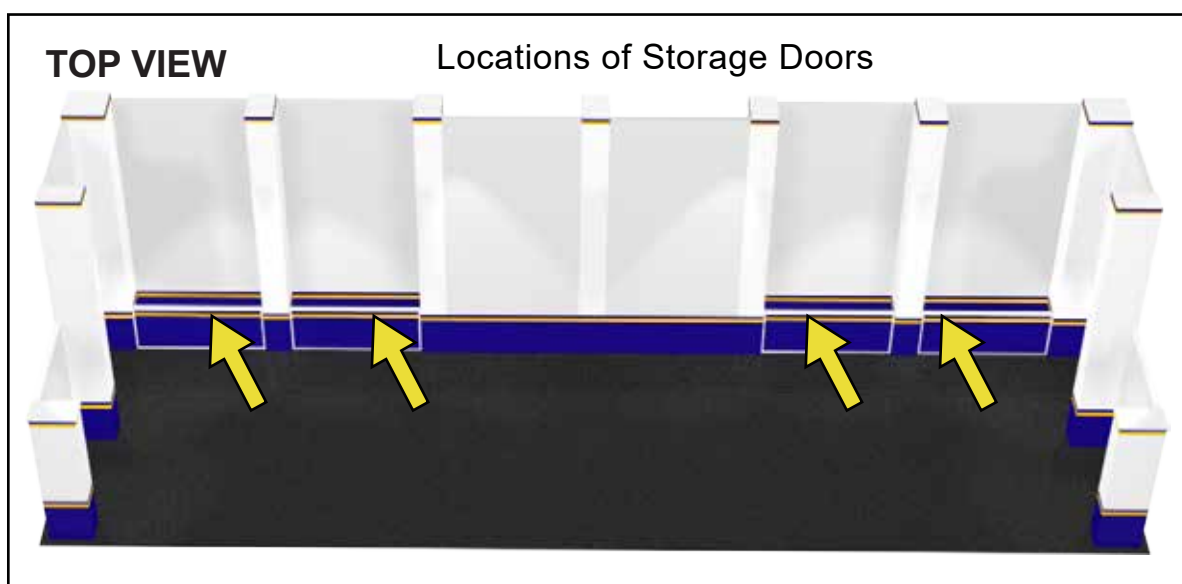

Install Shelf Support Bars.

A) Insert the shelf support bars into their designated openings in the Pillars with the **back bars** first, installing from the bottom upward. Then install the **front bars** from the bottom upward.

Make sure that the HARD (hook) Velcro on the bars is facing up to attach the shelves.

Bars with only (hook velcro go to the Back

Bars with hook and loop go to the Front (with the loop velcro facing the wall panel for lights to attach to.

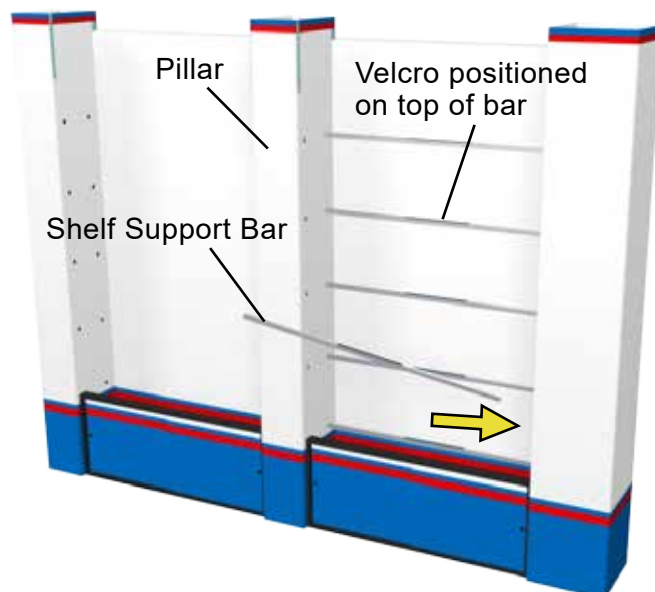

(See next page for Support Bar Detail)

Assembly Instructions: InfiniLite 30-04

Shelf Support Bar Detail for 10'x30' Booth Configuration:

There are three (2) sizes of Support Bars for the Shelves. The sizes and locations are shown below. Additionally, the Bars are color-coded to assist with identification during assembly.

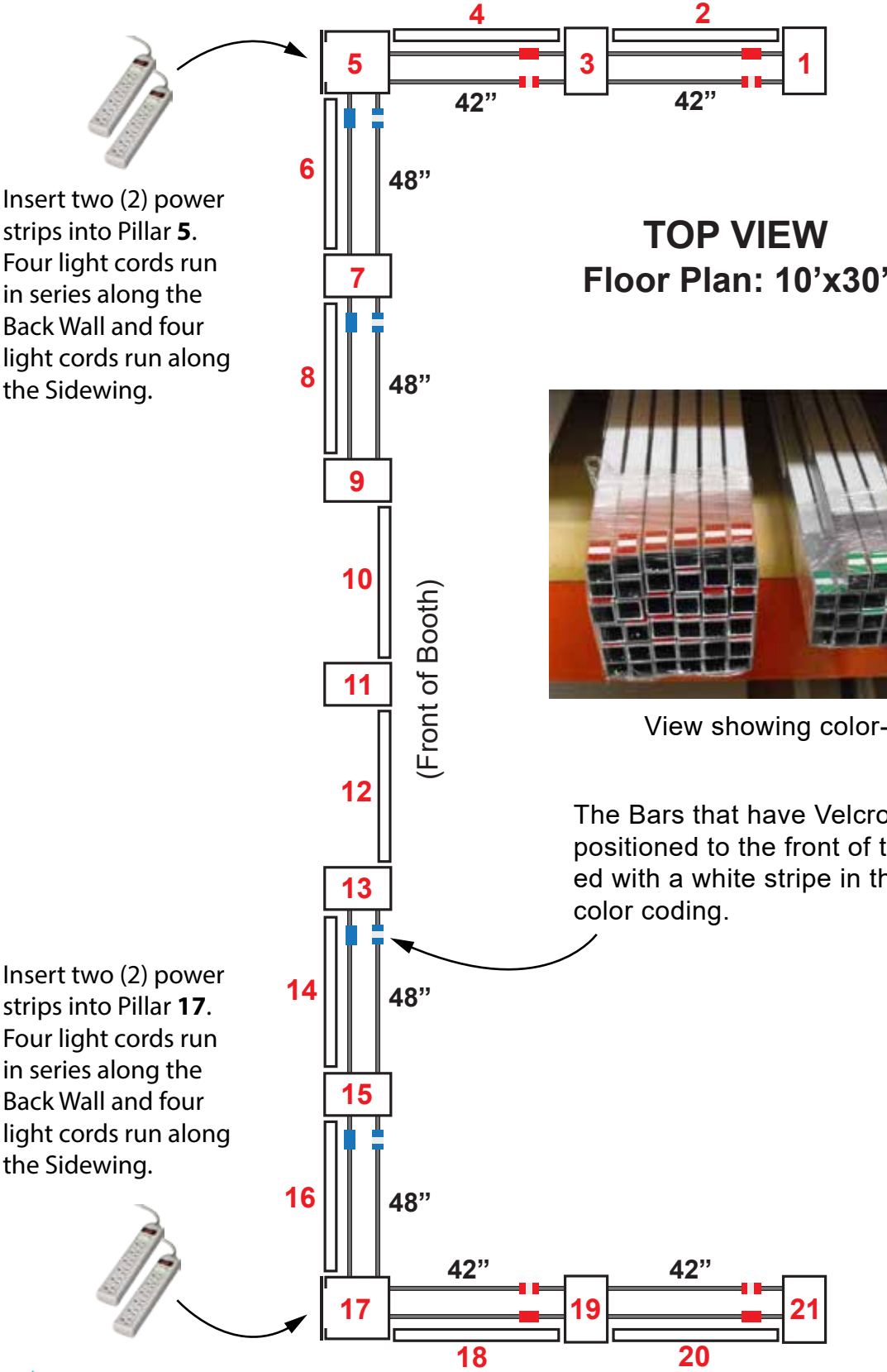

Insert two (2) power strips into Pillar 5. Four light cords run in series along the Back Wall and four light cords run along the Sidewing.

Insert two (2) power strips into Pillar 17. Four light cords run in series along the Back Wall and four light cords run along the Sidewing.

TOP VIEW
Floor Plan: 10'x30'



View showing color-coded bars.

The Bars that have Velcro for the LED Lights positioned to the front of the shelf are indicated with a white stripe in the middle of the color coding.

Assembly Instructions: InfiniLite 30-04

Shelf Support Bar Detail for 20'x20' Booth Configuration:

There are three (2) sizes of Support Bars for the Shelves. The sizes and locations are shown below. Additionally, the Bars are color-coded to assist with identification during assembly.

Insert one (1) power strip into Pillar **5**, **17**, **22**, and **25**.
Five light cords run in series along the Back Wall and Sidewings from each power strip.

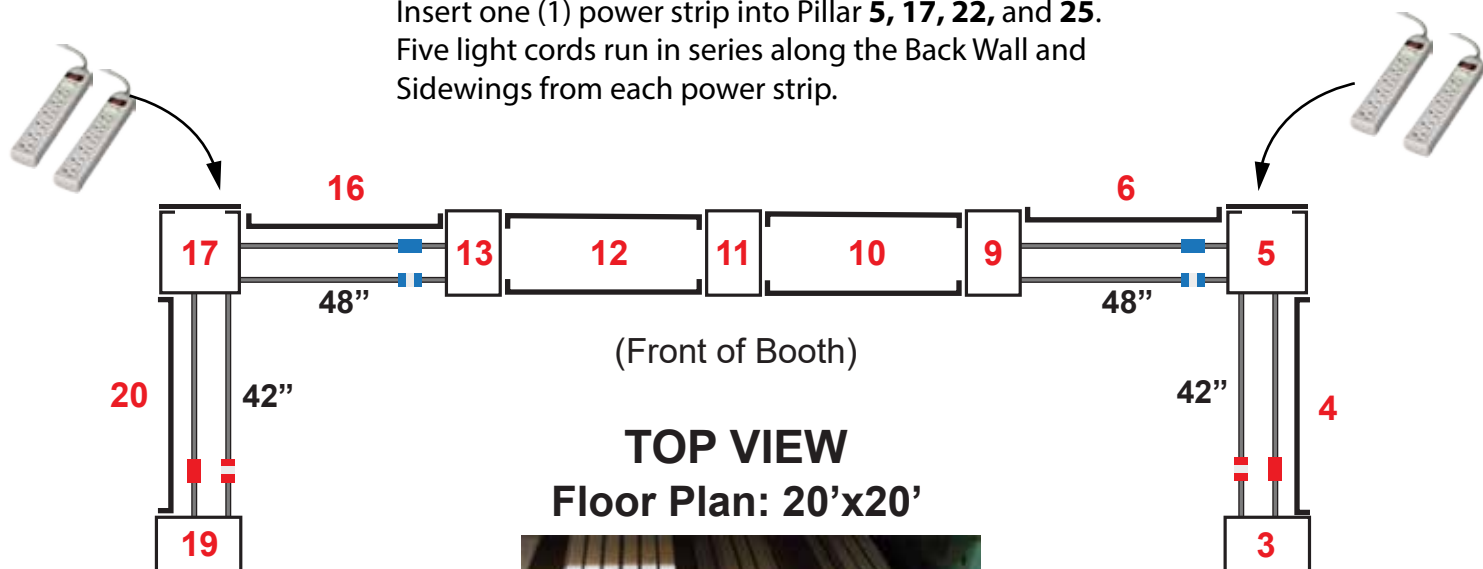

View showing color-coded bars.

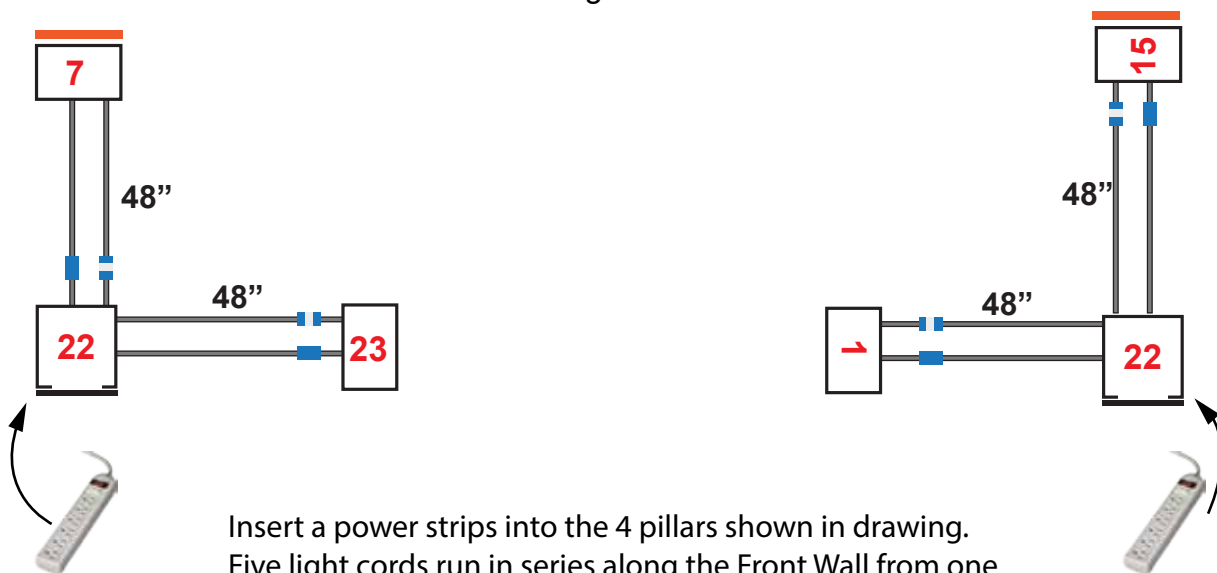

Insert a power strips into the 4 pillars shown in drawing.
Five light cords run in series along the Front Wall from one power strip and Five light cords run along the Sidewing from the other power strip.

Assembly Instructions: InfiniLite 30-04

LED Lamp Assembly Details

Step 1:



Start assembling the LED Lamps at the Pillars where the power will be connected. (Orient the Shelf Support Bars so that the Velcro is on top for the shelves and Velcro is in back of the front Bar for the LED Light.)

Step 2:

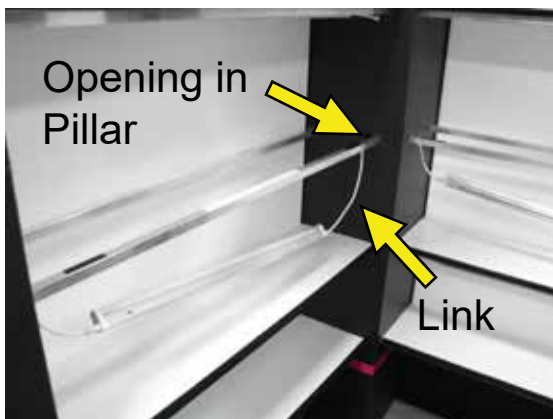

Attach LED Lights in series with Link Cables threaded through the openings in the Pillars.



Link Cable.

Step 3:



Attach the LED Lights to the back of the front Shelf Support Bars with Velcro.

Assembly Instructions: InfiniLite 30-04

LED Lamp Assembly Details

Step 4:



Support Bars for the LED Lamps at the tops of the Pillars are located behind the Signs. Assemble these bars so that the velcro is oriented to the back. Attach lights to the back of these supports with Velcro after they have been connected in series.

Step 5:

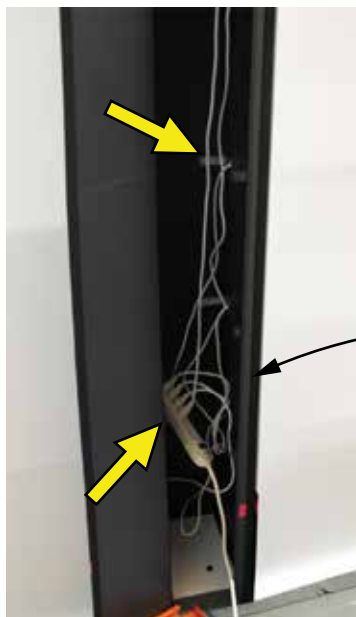

Connect the power for the LED Lights along the power strips located inside the Pillars as shown.

(Four light cords connected in series and plugged into the power strip inside the Pillar.)

Step 6:



Attach Shelves to the top of the Shelf Support Bars with Velcro.

Assembly Instructions: InfiniLite 30-04

Routing Method for Link Cables and Power Cords:

The following is an arrangement that can be used to attach the LED lights in series with power connected at the corner pillars.

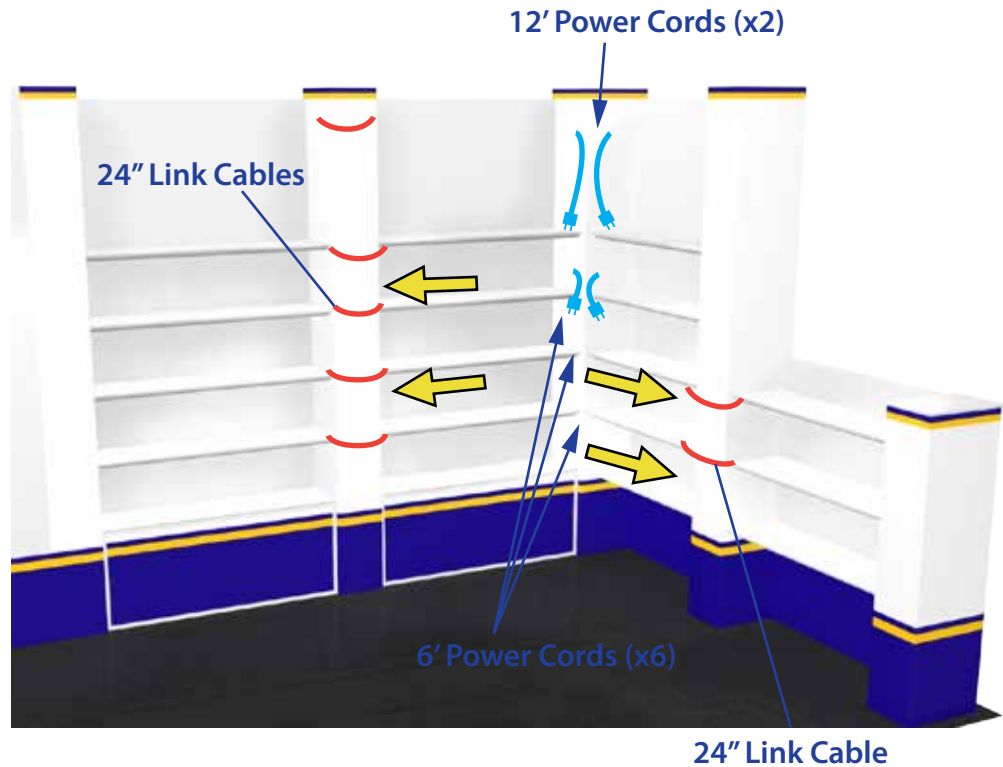

LEGEND

 24" Link Cable - used for short straight connections

Note (repeat same layout for left sidewing and for open sidewings on the 20'x20' Display)

Assembly Instructions: InfiniLite 30-04

Attach Shelves to Shelf Support Bars with Velcro.

A) Place the Shelves on top of the Shelf Support Bars and attach with Velcro.

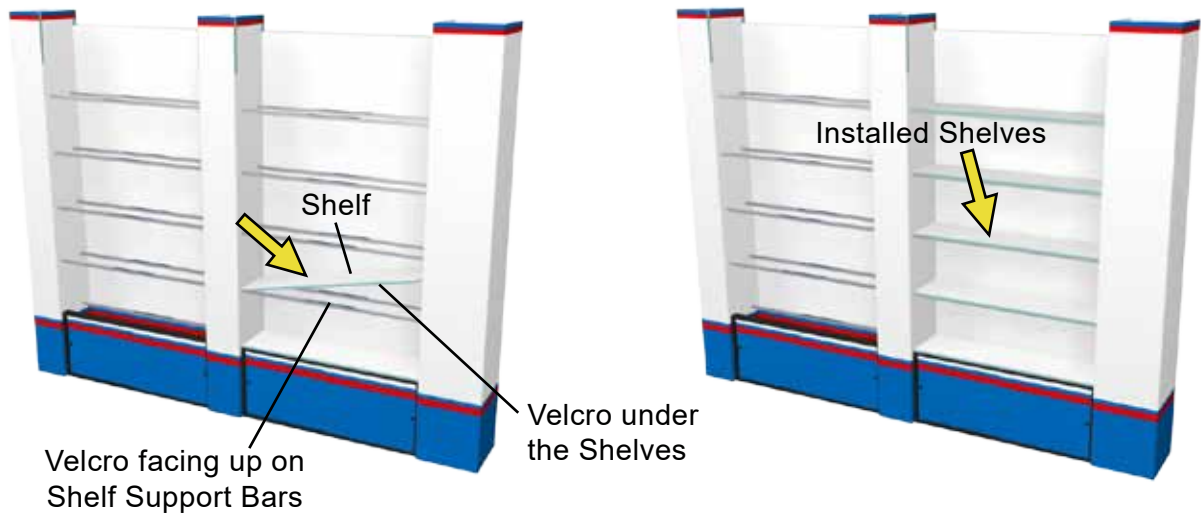

Backwall section



Front open wing sections for 20x20 Display

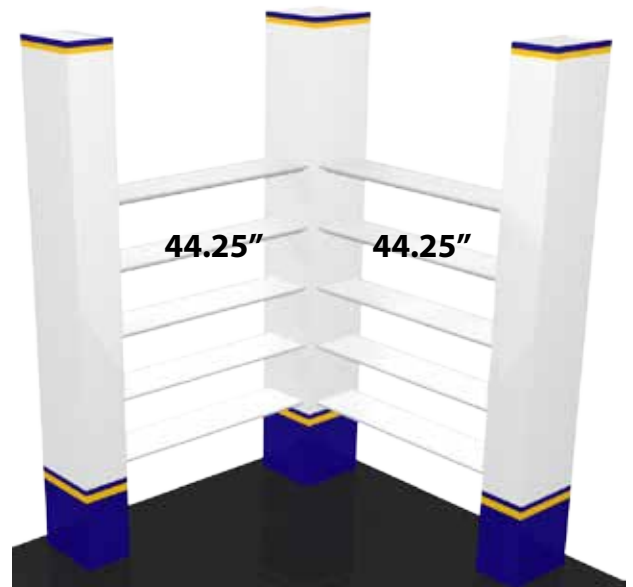

Assembly Instructions: InfiniLite 30-04

A) Unfold the Large Fabric Graphic and attach it to the middle Wall Panels and Center Pillar with Velcro.

B) Unfold and attach fabric prints to the outside of the side-wing panels With Velcro



Assembly Instructions: InfiniLite 30-04

Assemble Signs and attach to Pillars with Velcro.

A) Fold down the top sections of the Corner Signs along the flutes to form a triangle and Velcro closed.

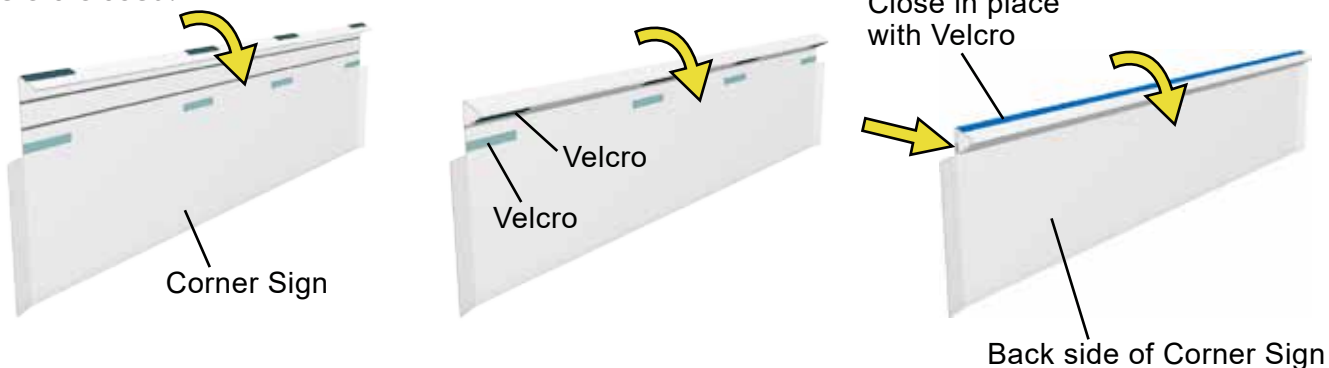

B) Attach Corner Signs and Small Signs to Pillars with Velcro.

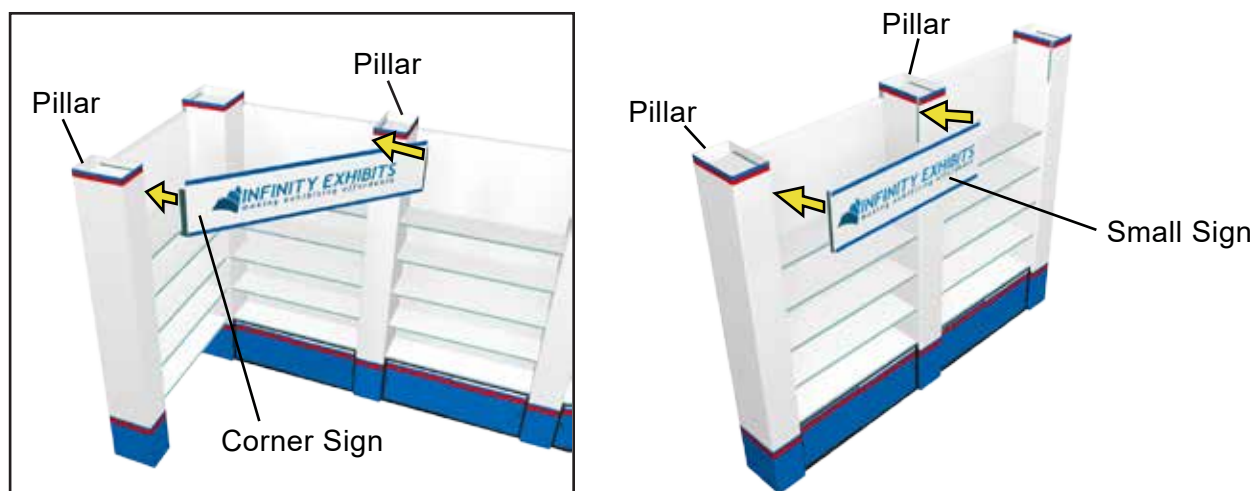

C) NOTE: The corner signs for the 10x30 backwall Display are smaller than the corner signs for the 20x20 Display

10'x30' Display Corner sign size = 63"

20'x20' Display Front wing Corner sign size = 66.5"

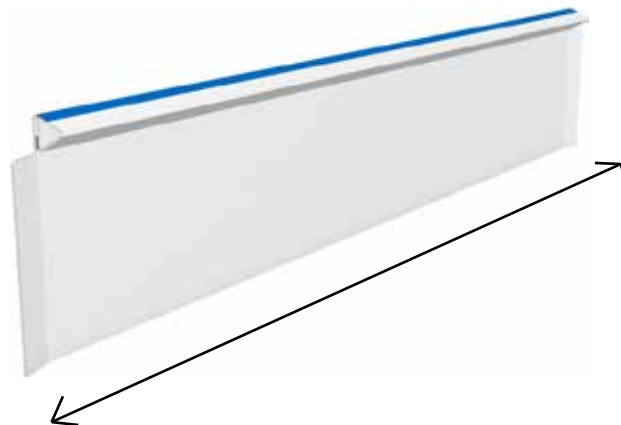

Assembly Instructions: InfiniLite 30-04

Sign location along the 10'x30' Booth Configuration is shown below:



Sign location along the 10'x20' Booth Configuration is shown below:



Assembly Instructions: InfiniLite 30-04

Attach the Stem Lights to the tops of the Pillars (if included with booth).

A) Place a wooden Light Support Stick on top of the proper Pillars as shown. (Use a ladder or step stool to access the top of the Pillar.) Secure the Stick to the back of the Pillar with a Binder Clip.

B) Attach the Stem Light to the front end of the Pillar and Support Stick by adjusting the thumbscrew on the back of the Stem Light. (**DO NOT** overtighten the thumbscrew. Overtightening the adjustment thumbscrew may damage the Pillar.)

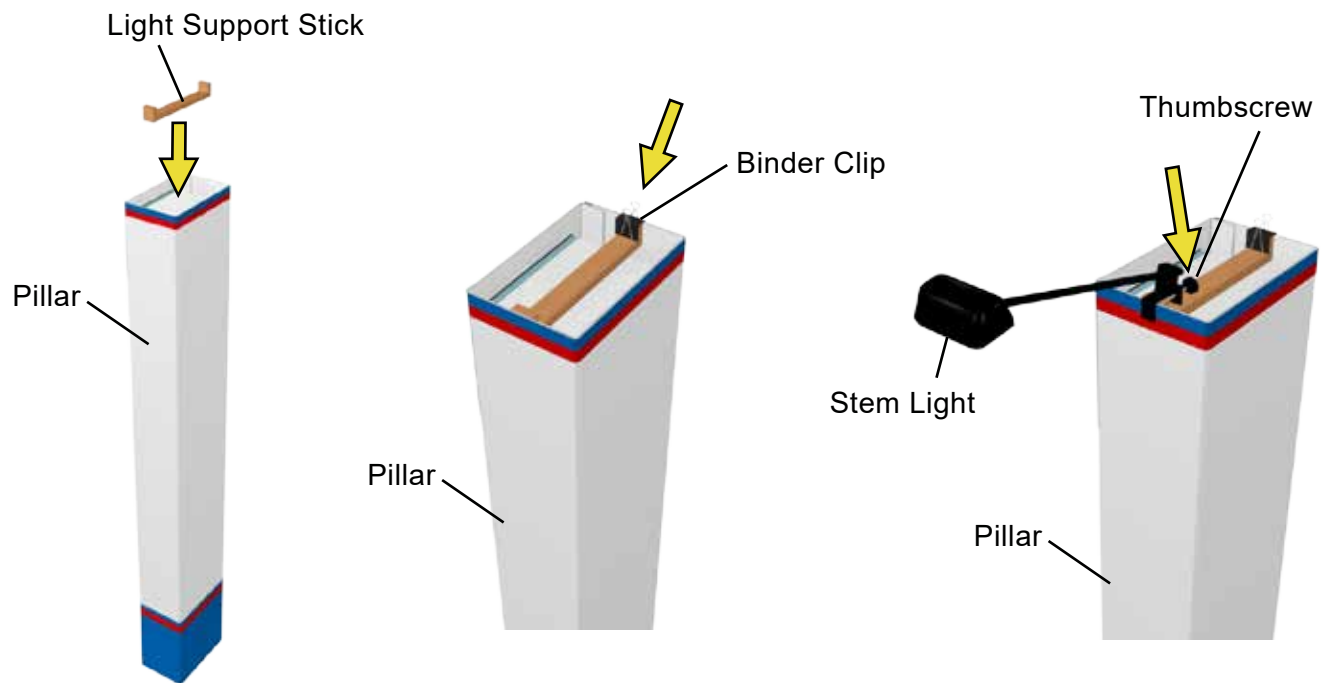

Assembly Instructions: InfiniLite 30-04

Case Layout

Divide the booth components and pack them in the tub and case in the following manner:

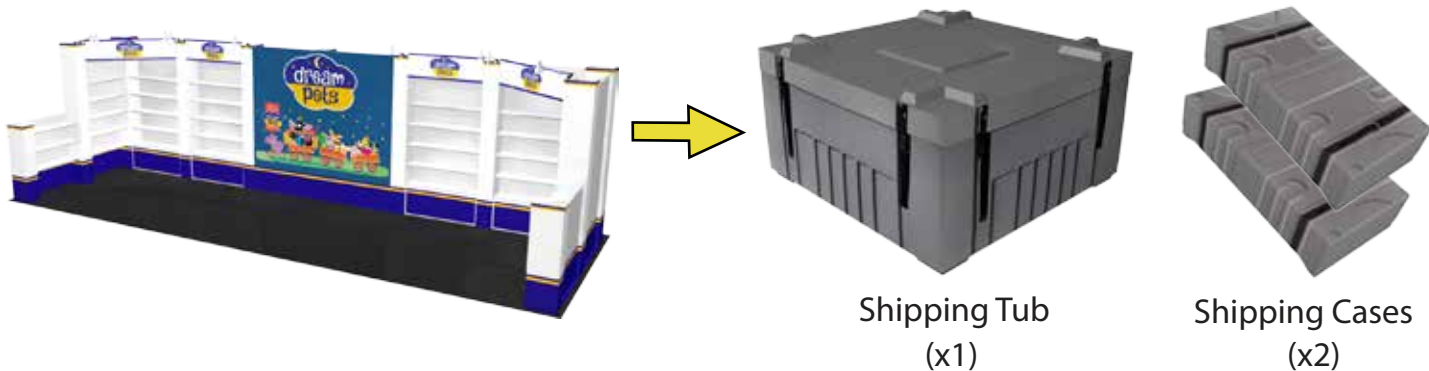

<u>Tub</u>	<u>10x30 Booth Components</u>	<u>Case</u>	<u>20x20 Booth Components</u>
1	<ol style="list-style-type: none"> 1) Posters 2) Signs 3) Wall Panels 4) Pillar Supports 5) Shelves 6) Pillars 7) Power Cords 8) Light sticks 9) Storage Frames 10) Aluminum Support Bars 	1	<ol style="list-style-type: none"> 1) Pillar Supports 2) Pillars 3) Signs
		2	<ol style="list-style-type: none"> 1) LED Lights 2) Electrical Cords 3) Posters 4) Support bars

NOTE: Pack the heavier components towards the bottom of the Tub and Cases.

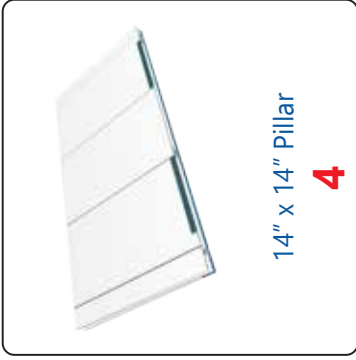

14' x 14' Pillar
4

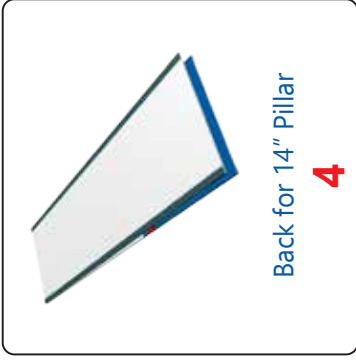

Back for 14' Pillar
4



9' x 14' Pillar
9

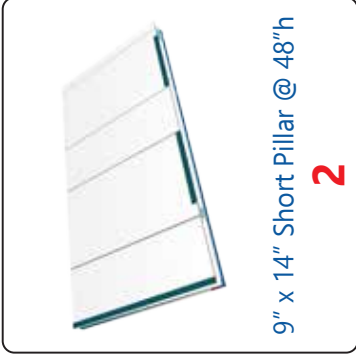

9' x 14' Short Pillar @ 48''h
2

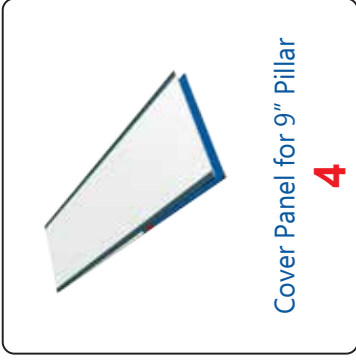

Cover Panel for 9' Pillar
4

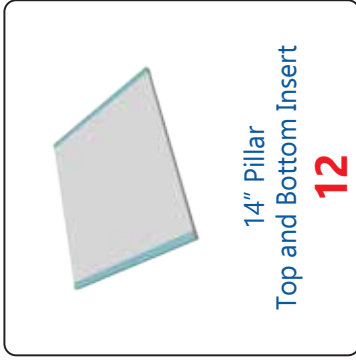

14' Pillar
Top and Bottom Insert
12

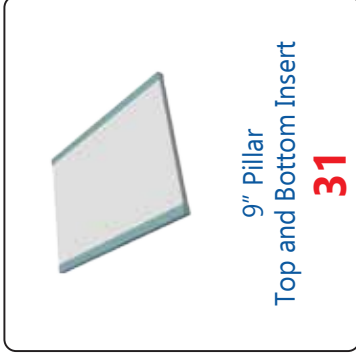

9' Pillar
Top and Bottom Insert
31



Backwall Support
2

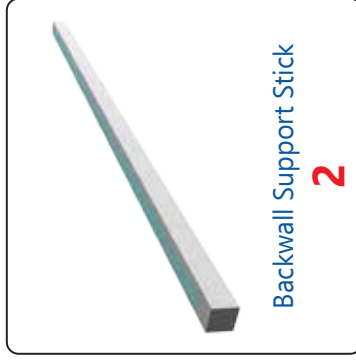

Backwall Support Stick
2



Corner Sign @ 66.5''
2



Corner Sign @ 62''
2

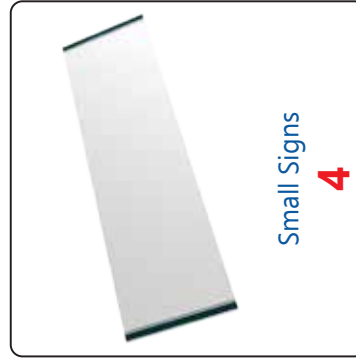

Small Signs
4

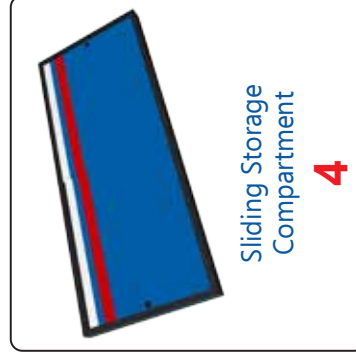

Sliding Storage
Compartment
4

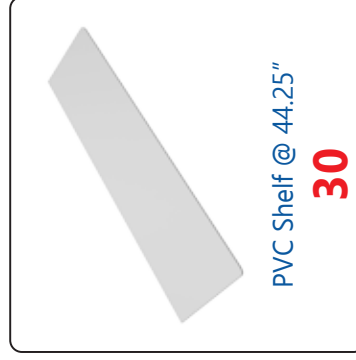

PVC Shelf @ 44.25''
30

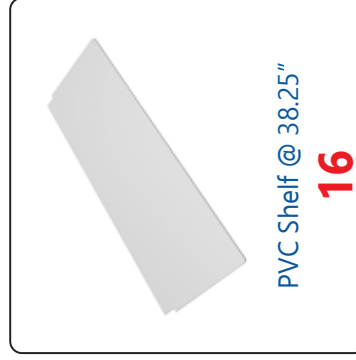

PVC Shelf @ 38.25''
16



48" Shelf Support Stick
48



44" Shelf Support Stick
32



White Stem Light - SL518
10



Extra Halogen Light Bulb
1



Wooden Light Stick
10

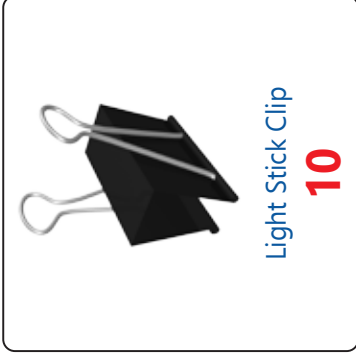

Light Stick Clip
10



Fluorescent Light
4



Fluorescent Power Cord - 12'
8



Fluorescent Power Cord - 6'
30



Fluorescent Link Cable - 24'
14

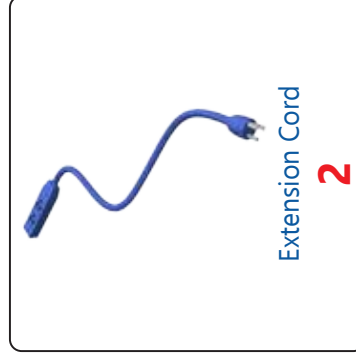

Extension Cord
2



Power Strip
4

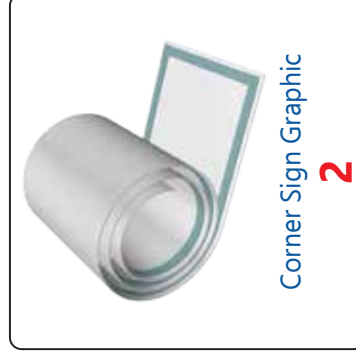

Corner Sign Graphic
2



Corner Sign Graphic
2



Small Sign Graphic
4

