

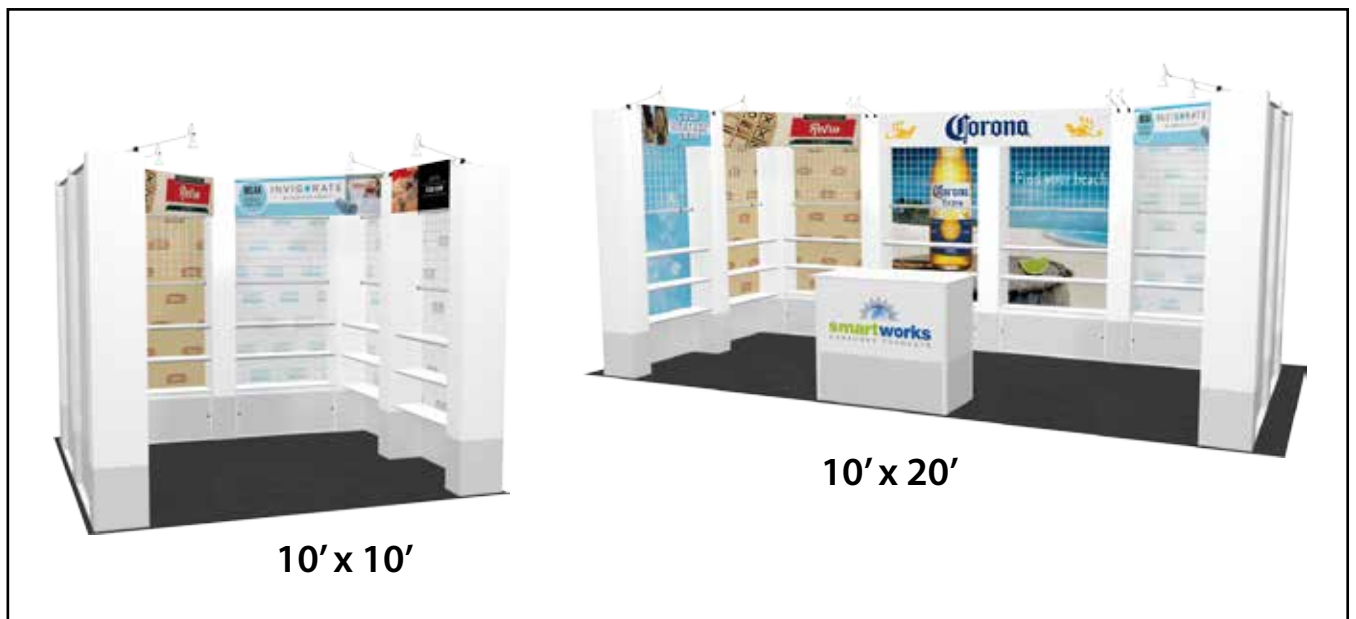

Display Setup Instructions



Alternate Booth Configurations:



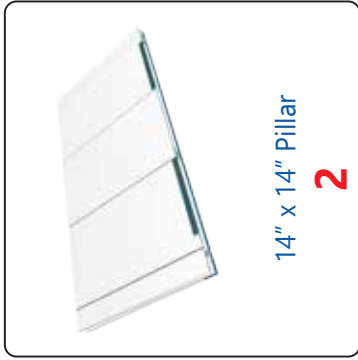

14" x 14" Pillar
2

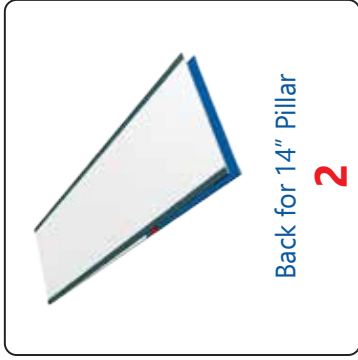

Back for 14" Pillar
2



9" x 14" Pillar
9

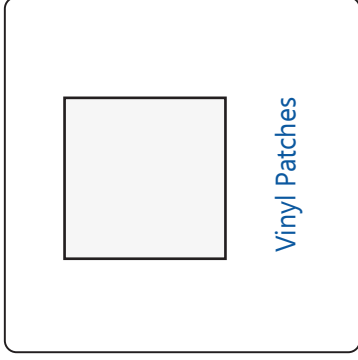

Vinyl Patches



44" Wall Panel
4



40" Wall Panel
2



38" Wall Panel
4



Large Sign
1



Corner Sign
2

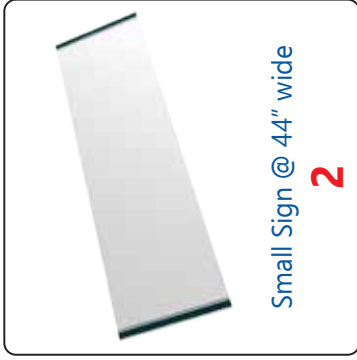

Small Sign @ 44" wide
2

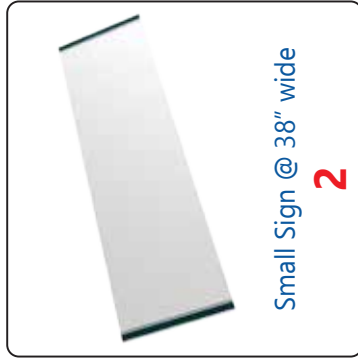

Small Sign @ 38" wide
2

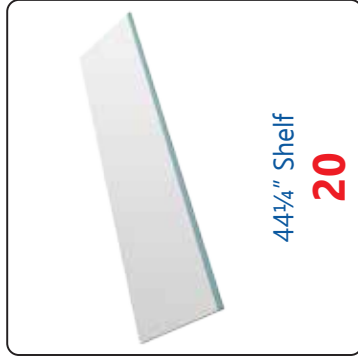

44 $\frac{1}{4}$ " Shelf
20



40 $\frac{1}{4}$ " Shelf
10

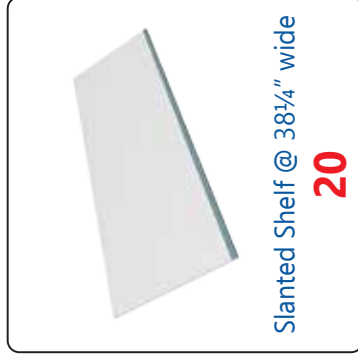

Slanted Shelf @ 38 $\frac{1}{4}$ " wide
20



48" Shelf Support Stick
36



44" Shelf Support Stick
18



42" Shelf Support Stick
36

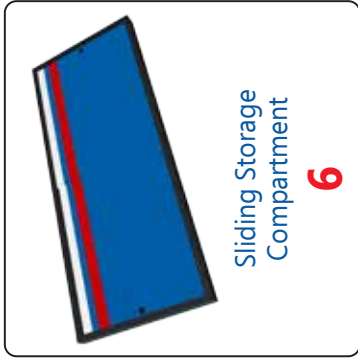

Sliding Storage
Compartment
6

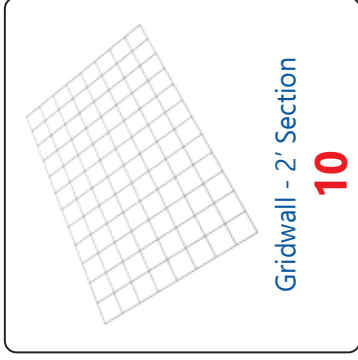

Gridwall - 2' Section
10



Gridwall Hanging Bar
20



White Stem Light - SL518
10



Wooden Light Stick
10



Light Stick Clip
10



Extra Halogen Light Bulb
1

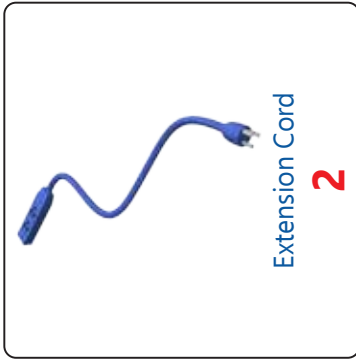

Extension Cord
2



Power Strip
2

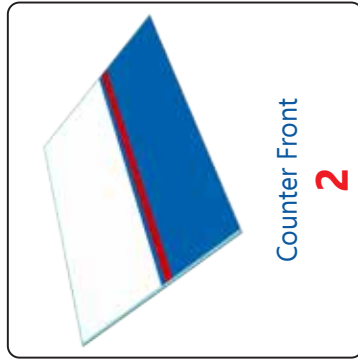

Counter Front
2

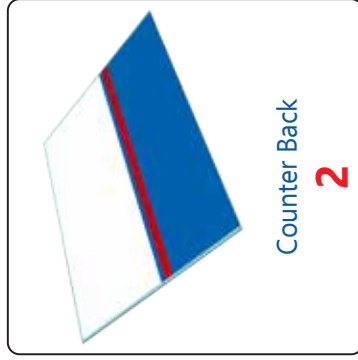

Counter Back
2

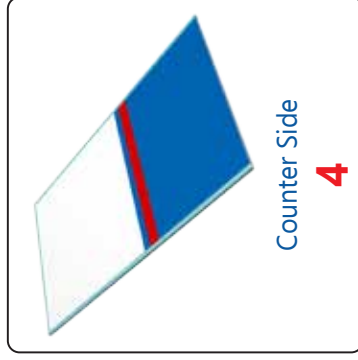

Counter Side
4

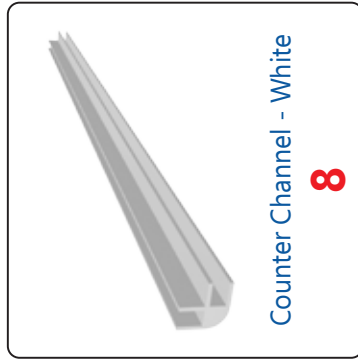

Counter Channel - White
8

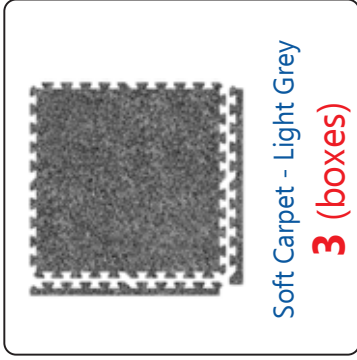
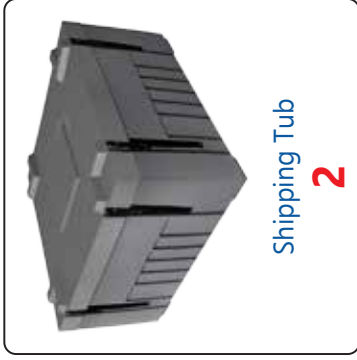
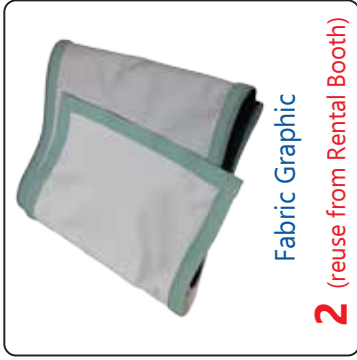
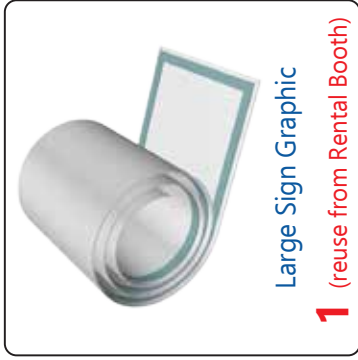
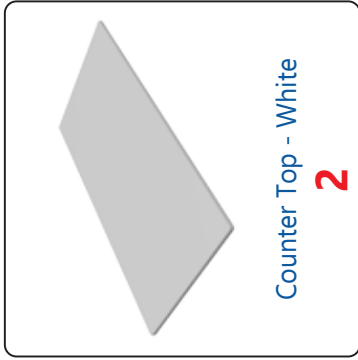



Steps to Assemble the InfiniLite Multi Section Exhibit Booth:

- Step 1:** Install the Soft Carpet within the booth area.
- Step 2:** Assemble the Pillars and Corner Pillars.
- Step 3:** Place Pillars upright in their proper order and orientation.
- Step 4:** Attach Wall Panels to Pillars.
- Step 5:** Attach the Posters to the Wall Panels with Velcro.
- Step 6:** Install the Shelf Support Bars into sides of Pillars.
- Step 7:** Install the Storage Doors.
- Step 8:** Attach the Shelves to Shelf Support Bars with Velcro.
- Step 9:** Install the Gridwall into sides of Pillars (as required).
- Step 10:** Attach the Signs to inside of Pillars with Velcro.
- Step 11:** Attach Stem Lights to top of Pillars.
- Step 12:** Assemble the Counters and place them within the booth area.

Enter the link below for an instructional video:

<http://youtu.be/-INxoiV-fG4>

Assemble the Soft Foam Flooring within the booth area.

A) Interlock the soft foam tiles and edging to install the modular floor system.

(1) Connect the tiles together along the edges.

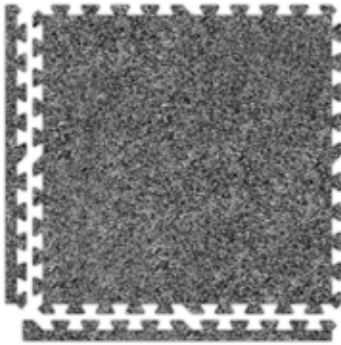

Light Grey Soft Carpet

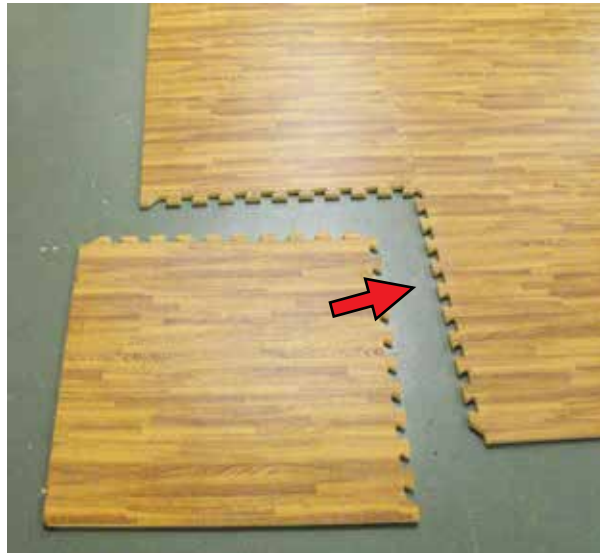

(2) Assemble the flooring into the orientation and size desired.



(3) The flooring is modular and may be installed in configurations such as 10'x10', 10'x20', 10'x30' or 20'x20' depending on the amount of tiles used.

Assemble Pillars.

A) Unfold the Pillar Panels with the front sides facing downward.

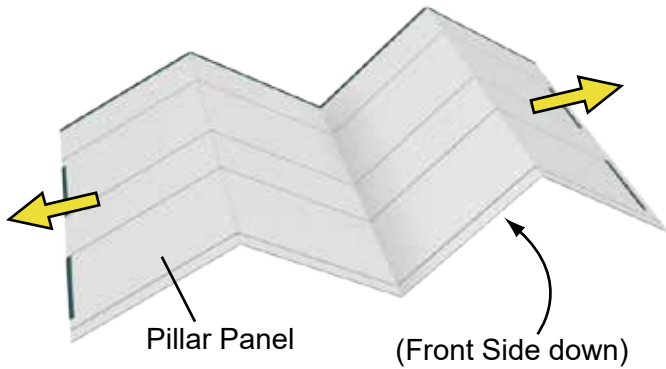

B) Attach Top and Bottom Supports to the back of the Pillars with Velcro.

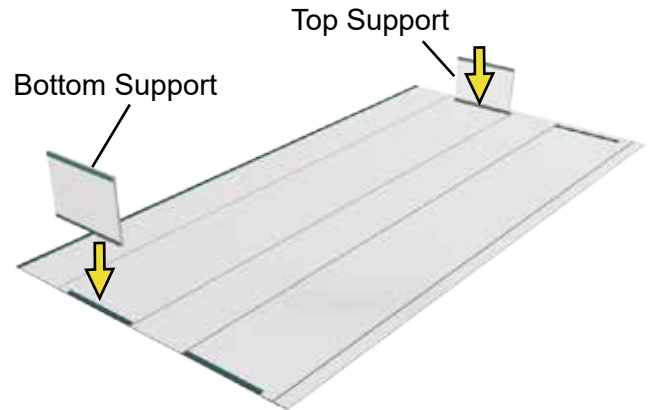

C) Fold Pillar around the Supports and attach with Velcro.

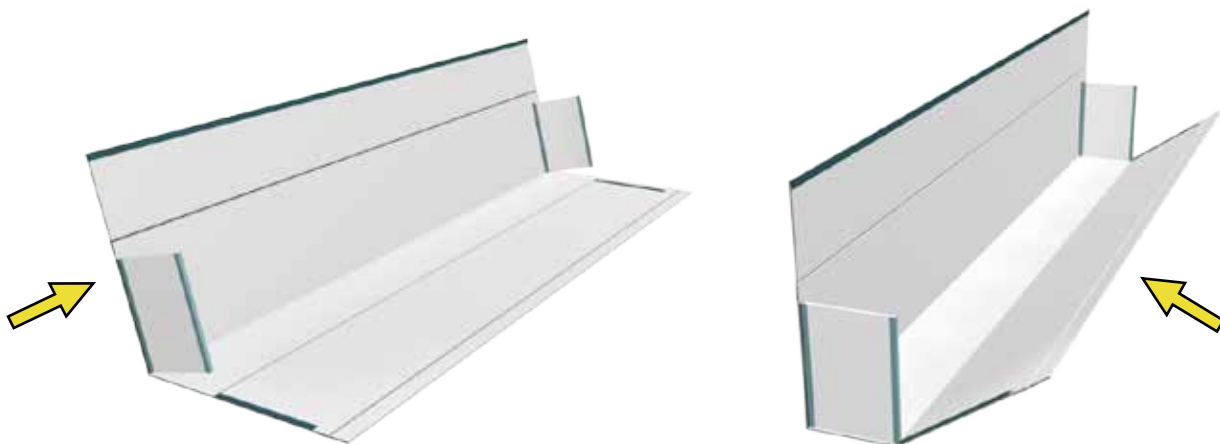

D) Close the Pillar using the Velcro strips along the Pillar edges.

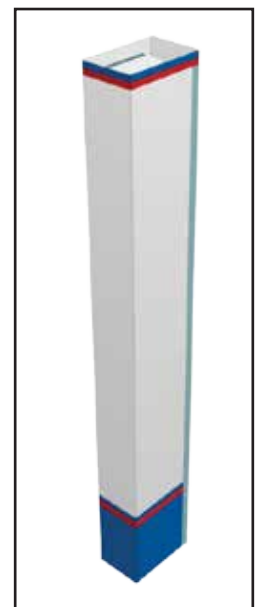
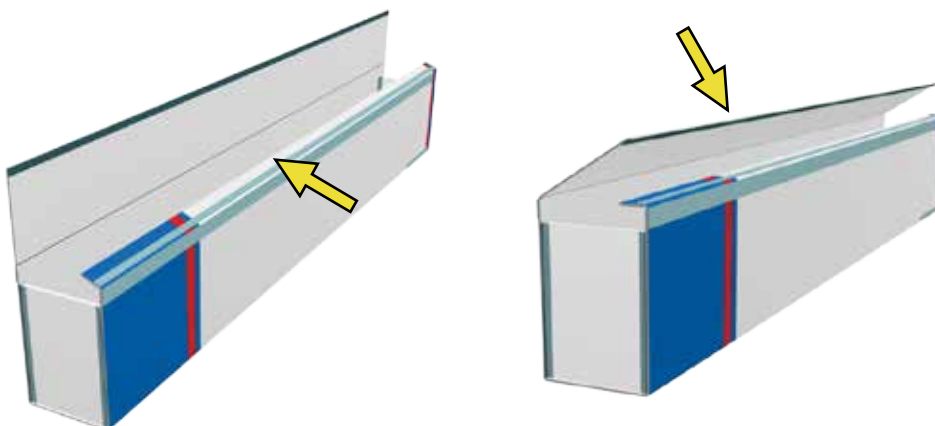

Assembled Pillar

Assemble Corner Pillars.

E) Unfold the Corner Pillar Panels with the front sides facing downward.

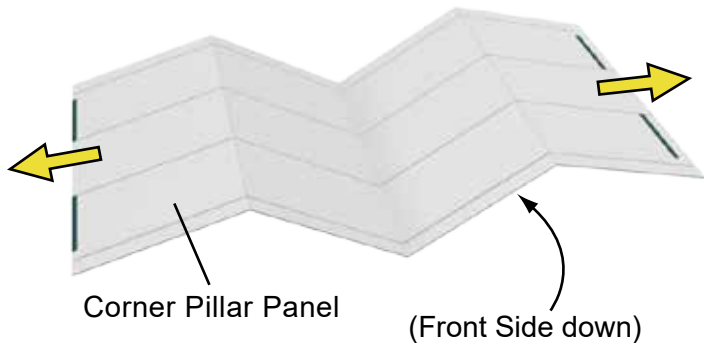

F) Attach Top and Bottom Supports to the back of the Corner Pillars with Velcro.

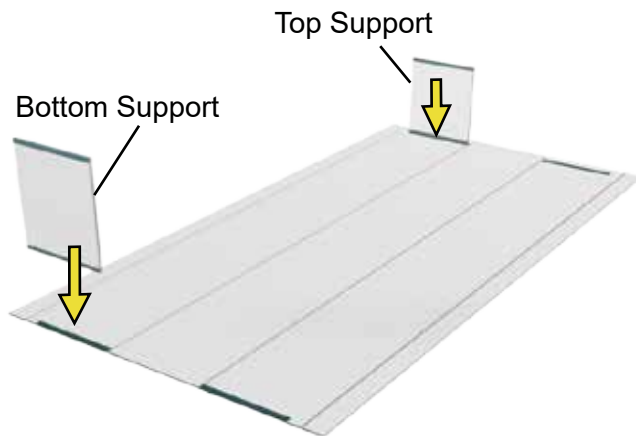

G) Fold the Corner Pillar around the Supports and attach with Velcro.

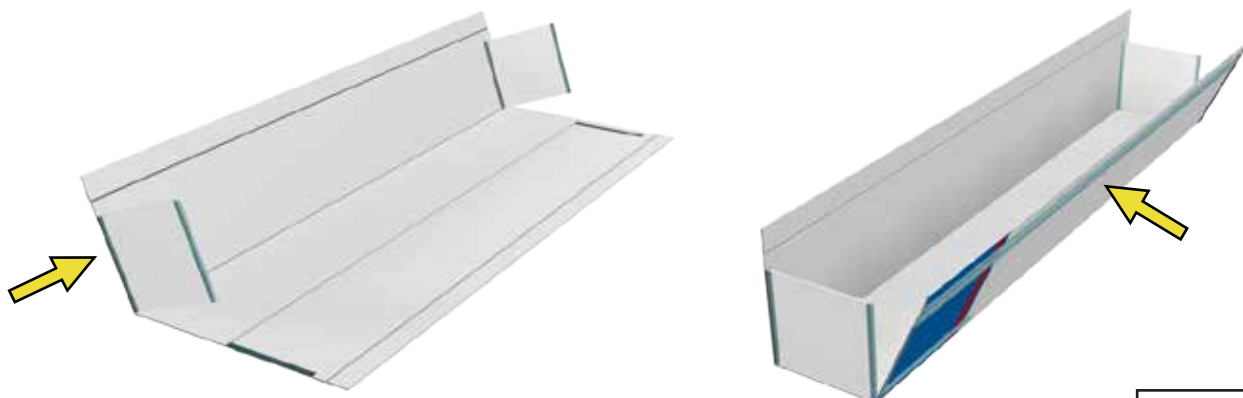

H) Attach the Back Cover to the bottom half of the Corner Pillar with Velcro; unfold the Back Cover; then attach the remaining Back Cover to the upper half of the Corner Pillar.

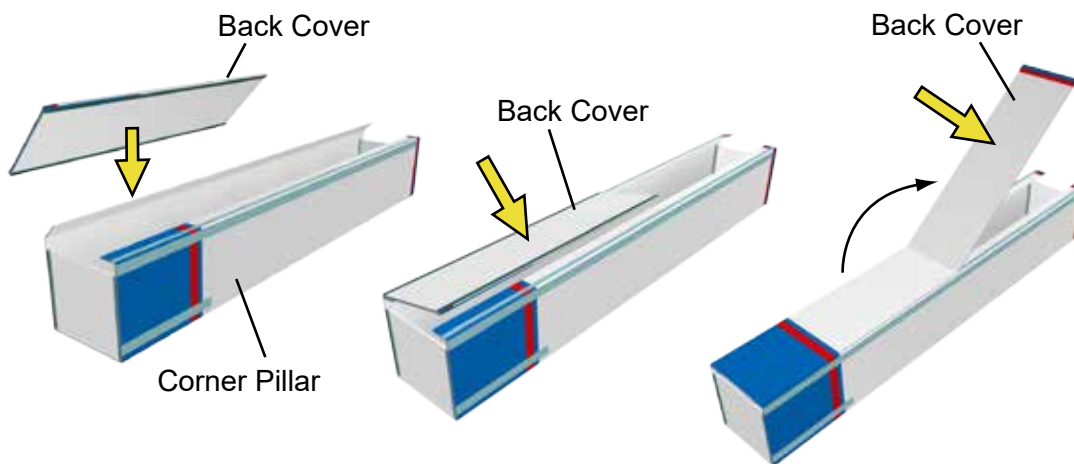

Assembly Instructions: InfiniLite 30-03

The following Floor Plan identifies the locations of the Booth Components for the 10'x30' booth display:

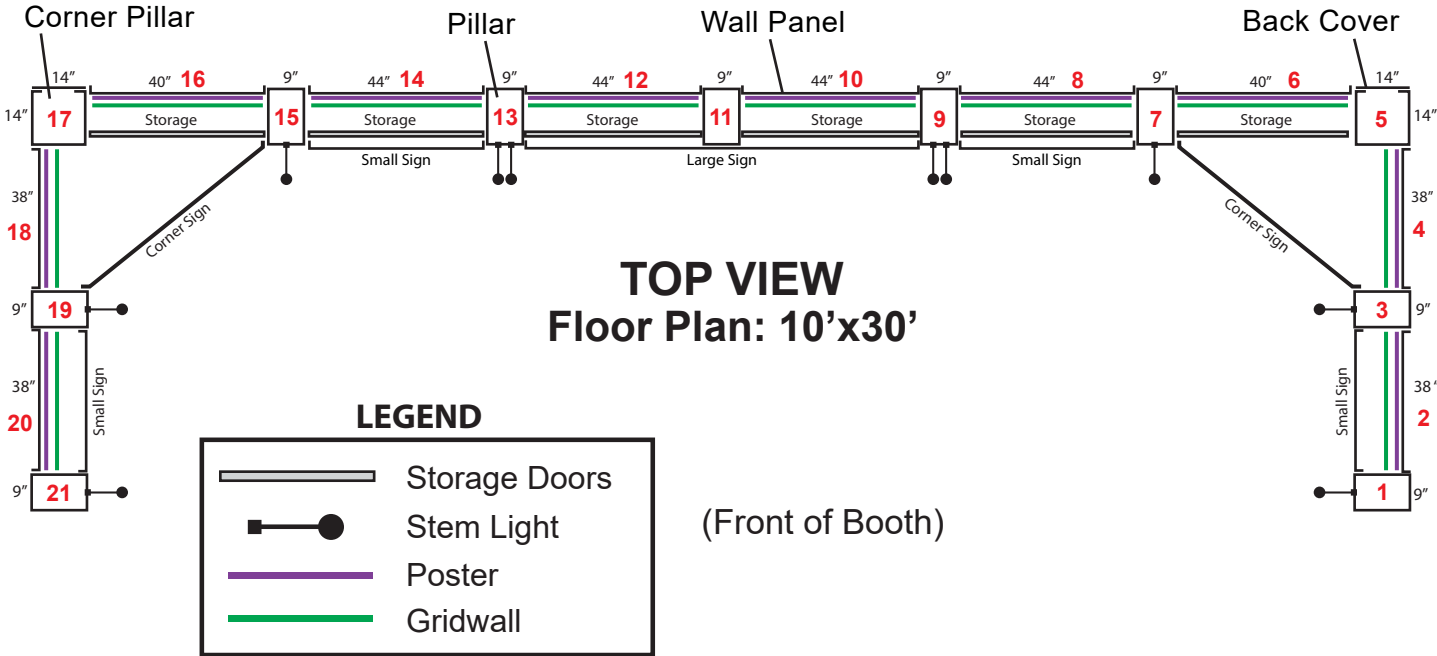

Place the assembled Pillars and Corner Pillars upright in their proper order and assigned locations as numbered and indicated on the Floor Plan.

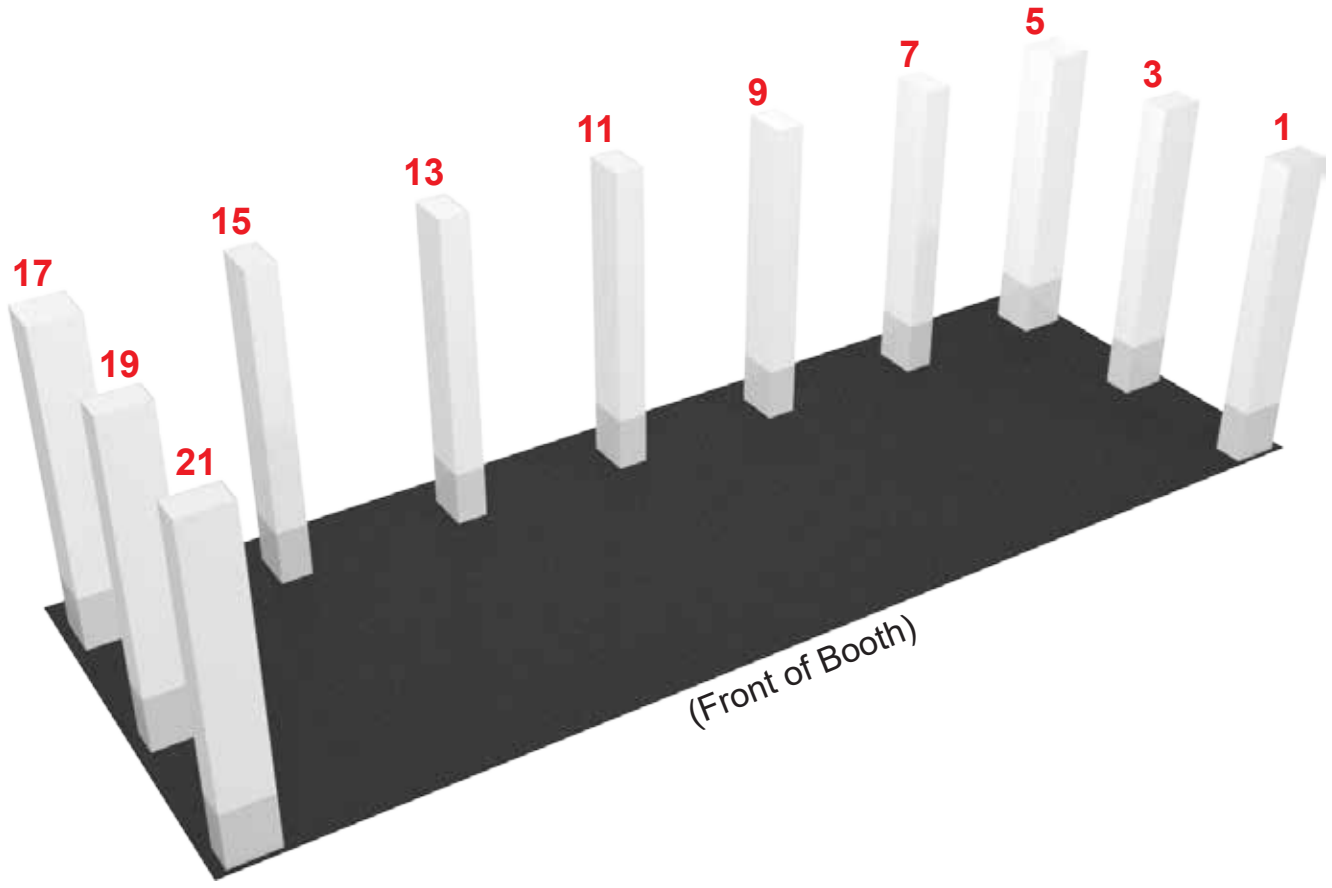

The following Floor Plan identifies the locations of the Booth Components for the 10'x20' booth display:

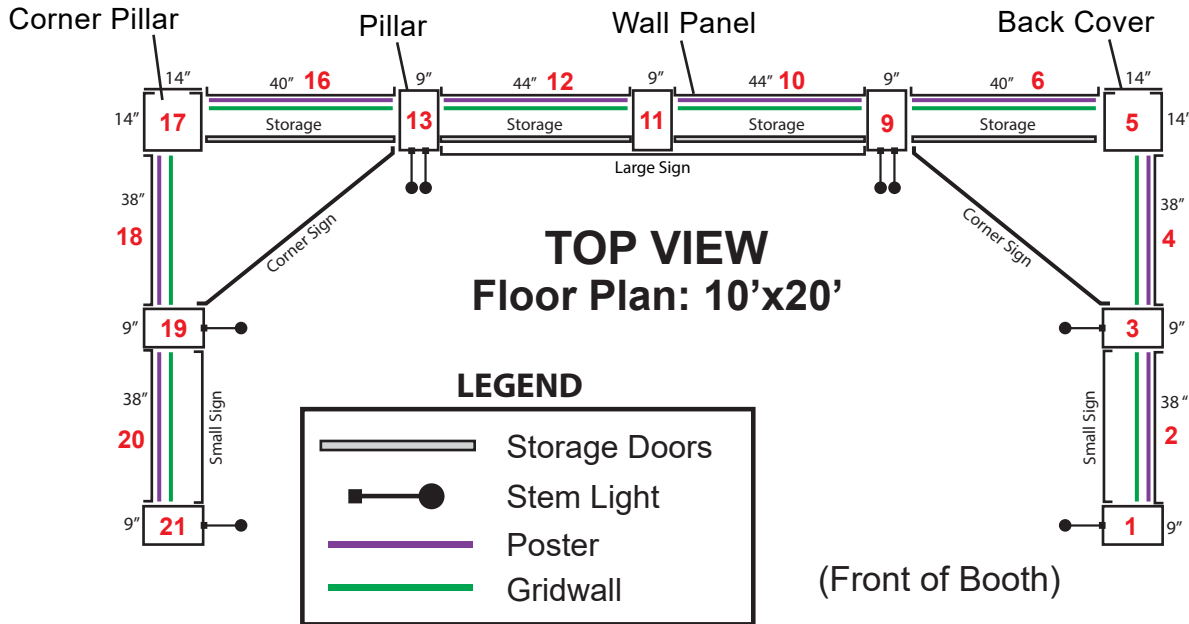

Place the assembled Pillars and Corner Pillars upright in their proper order and assigned locations as numbered and indicated on the Floor Plan.

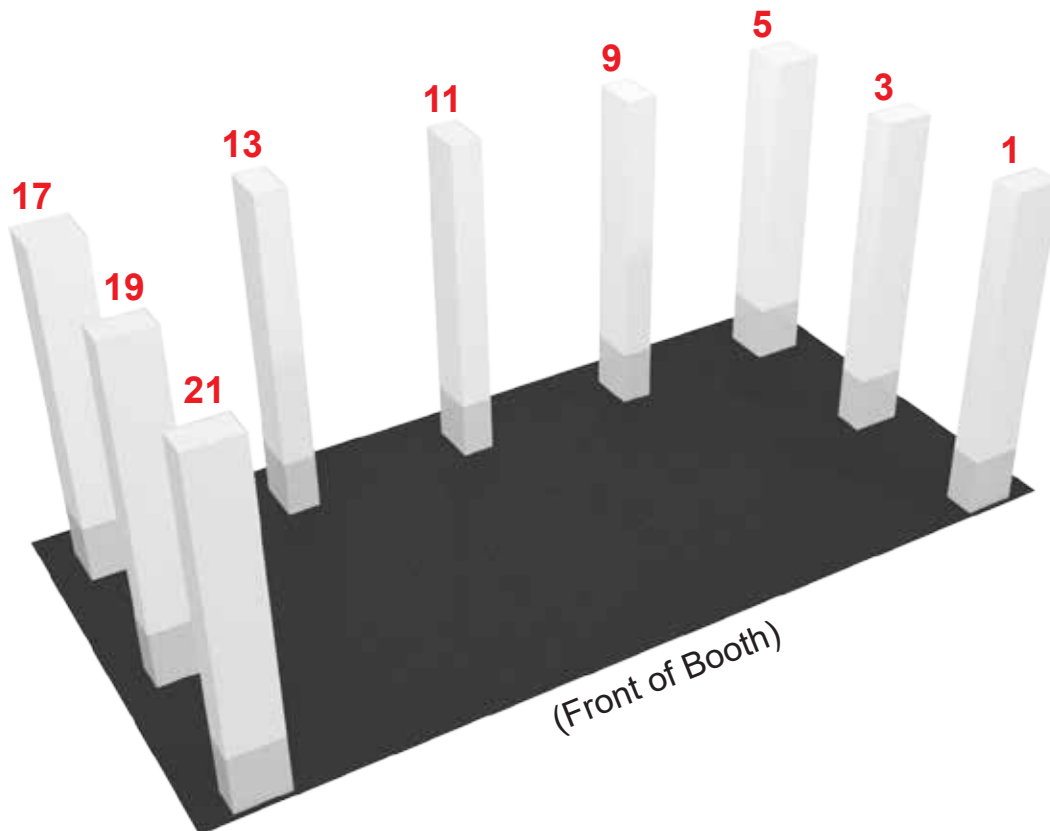

The following Floor Plan identifies the locations of the Booth Components for the 10'x10' booth display:

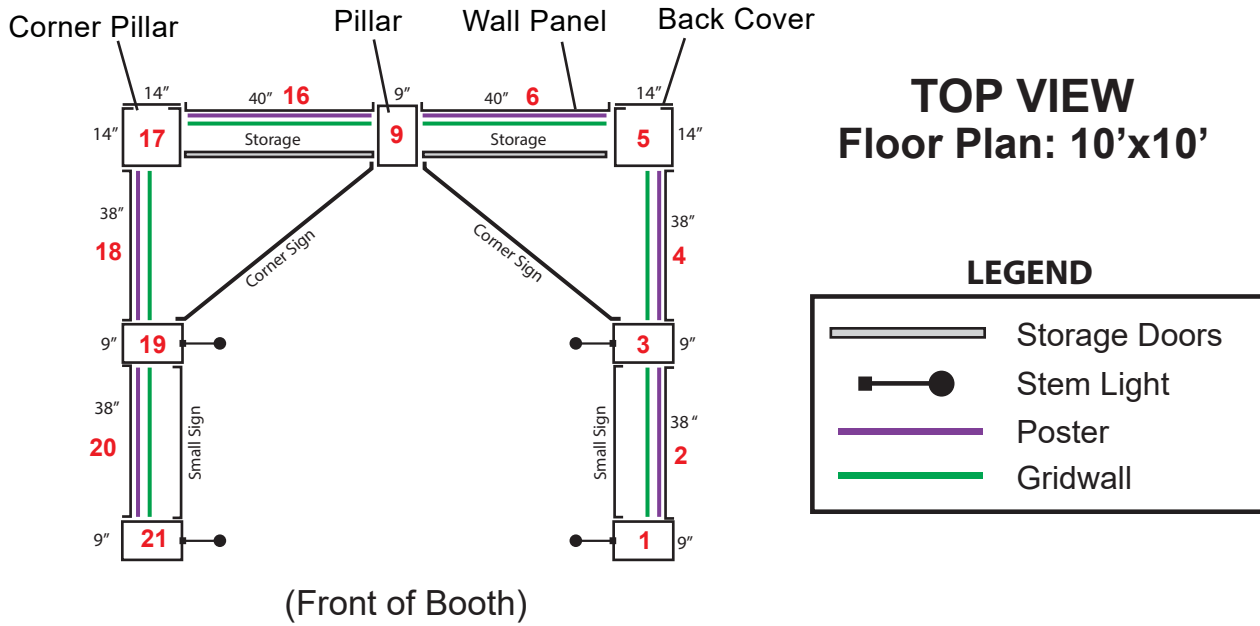

Place the assembled Pillars and Corner Pillars upright in their proper order and assigned locations as numbered and indicated on the Floor Plan.

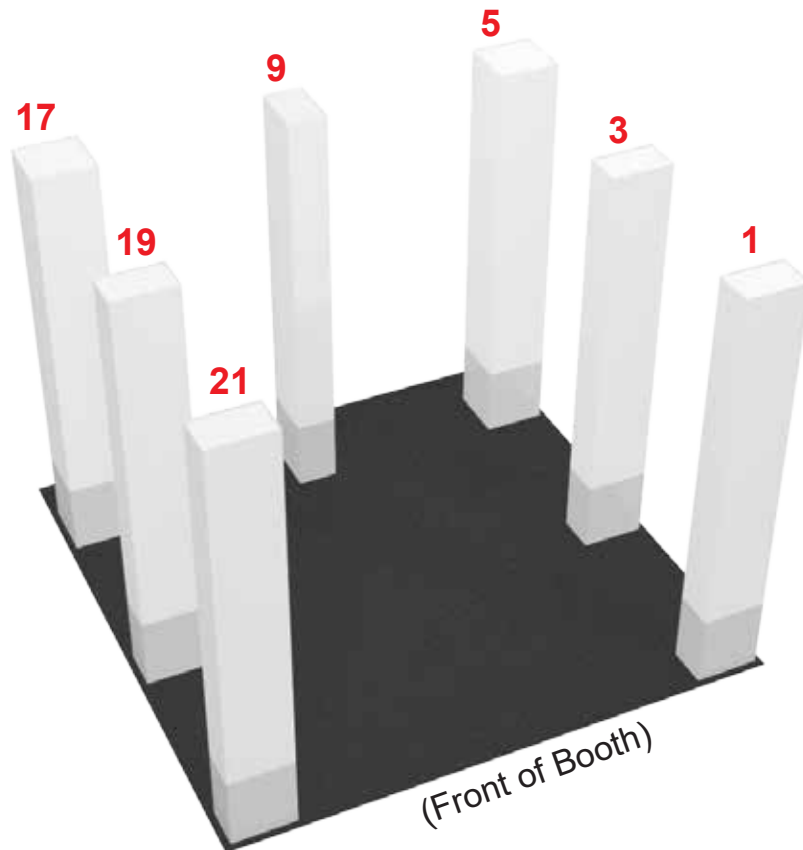

Attach Wall Panels to Pillars.

A) Unfold the bottom half of the Wall Panel, hold upright and attach to the side of the Pillar with Velcro. (Make sure that the Pillar and Wall Panel are **flat** on the floor surface when attaching and that the accent stripes are aligned with each other.) Begin assembly from either the left or right side of the Booth.

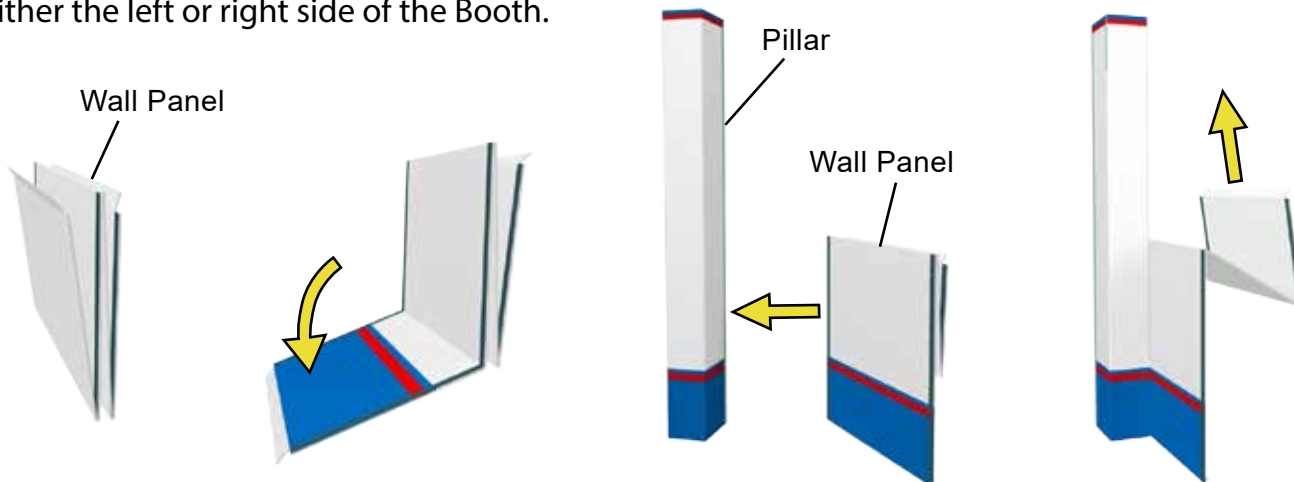

B) Unfold the top half of the Wall Panel and attach it to the top half of the Pillar matching the Velcro strips along the edges. Rotate the Wall Panel into position. Attach the next Pillar to the Wall Panel so that it is flat against the front face of the Wall Panel. Rotate the Pillar into position.

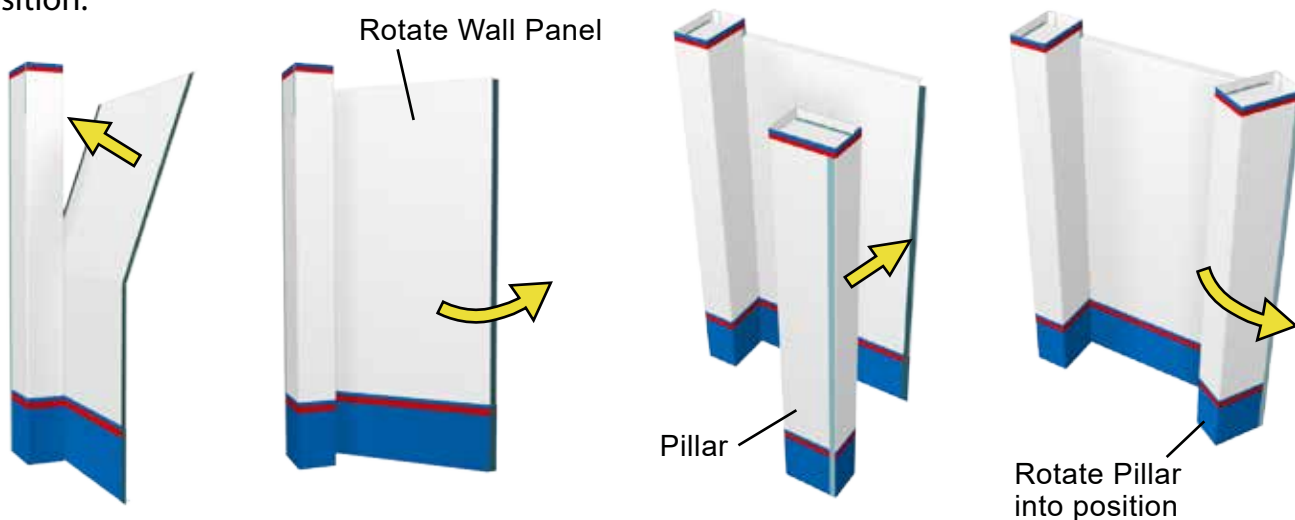

C) Repeat this process with the remaining Wall Panels and Pillars.



Assembly Instructions:

InfiniLite 30-03

Attach the Posters to the Wall Panels with Velcro.

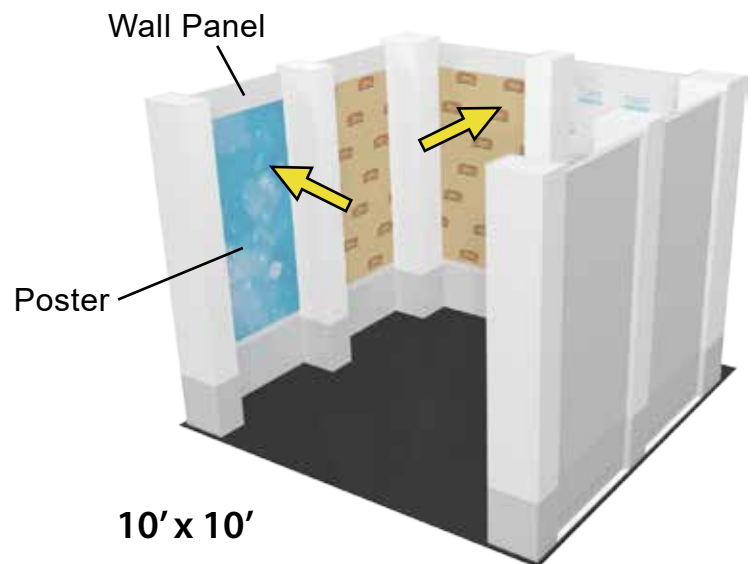
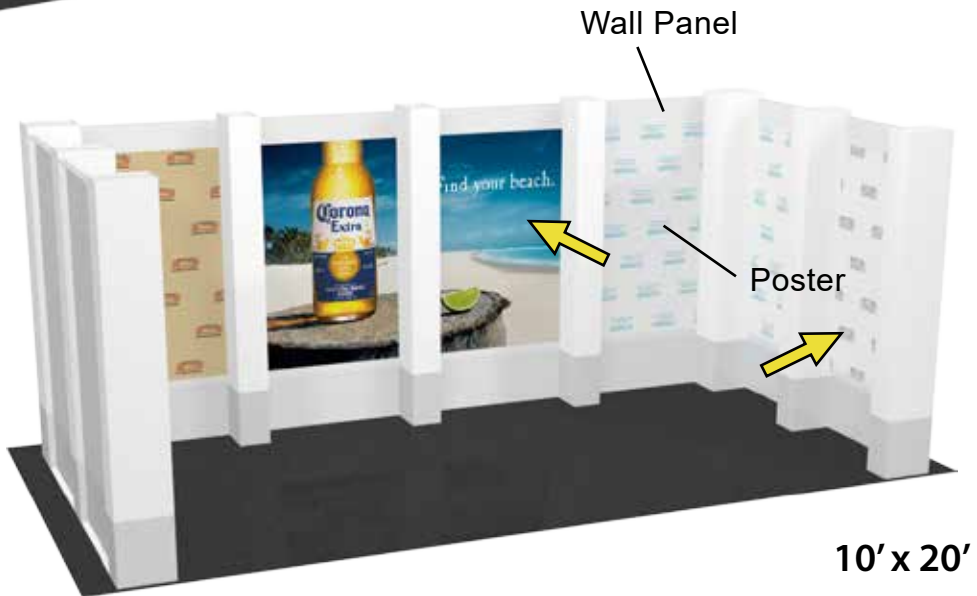

Assembly Instructions: InfiniLite 30-03

Install the Shelf Support Bars.

A) Insert the shelf support bars into the designated openings in the Pillars.

Make sure that the **Velcro on the bars is facing upward** to attach the shelves.

NOTE: The shelves are adjustable.



B) There are (3) different sizes of Shelf Support Bars. The bar sizes are identified with different colors to assist in the booth assembly.

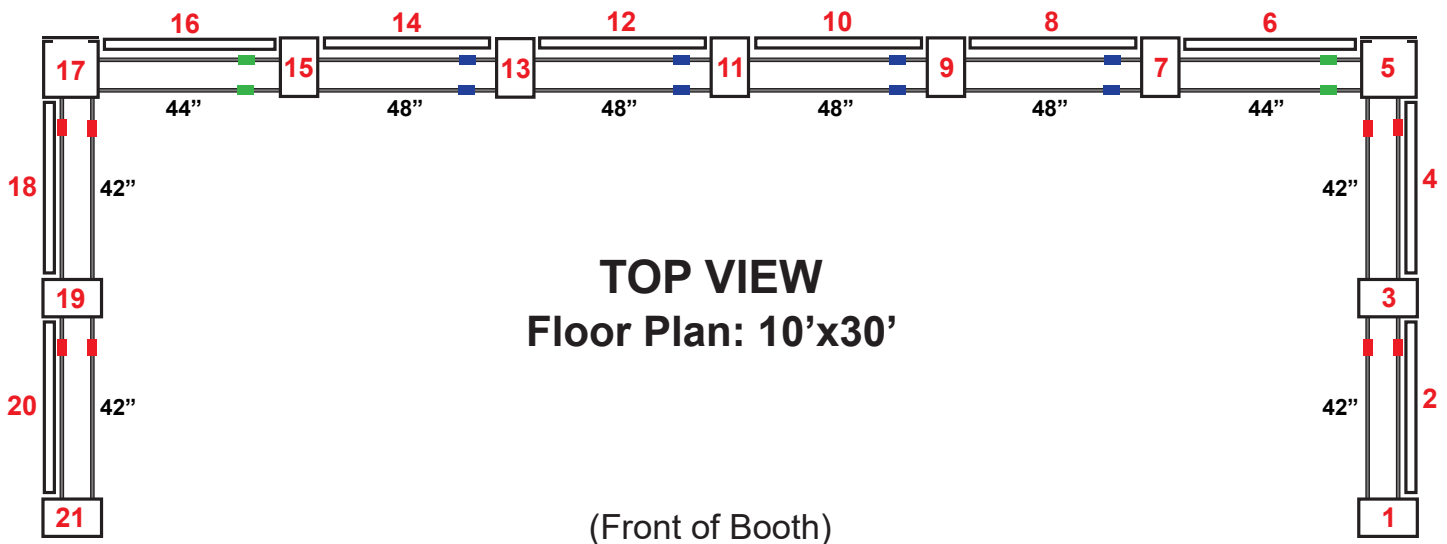

NOTE: The Hanging Bars for the Gridwall Panels also have (3) different sizes similar to the shelf support bars.

Assembly Instructions:

InfiniLite 30-03

Install the Storage Doors. (Attach Storage Doors to the inside of the Pillars with Velcro.)



Attach Shelves to Shelf Support Bars and top of Storage Doors with Velcro.

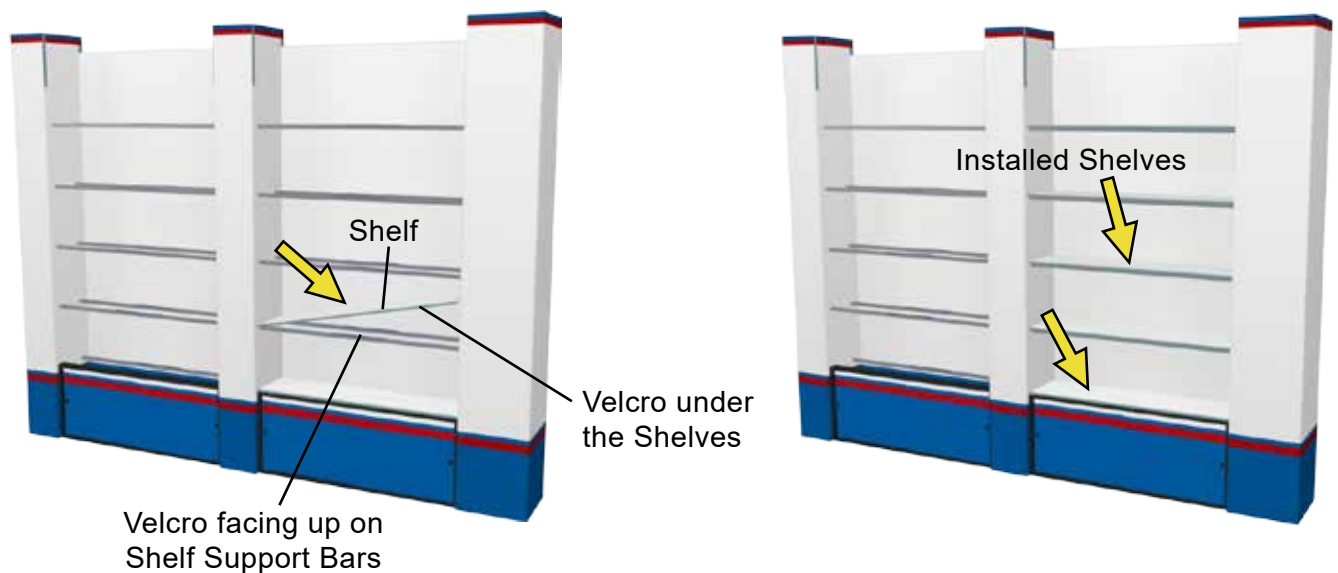

NOTE: Images on this page show typical installation of Shelf Support Bars, Storage Doors and Shelves.

NOTE: The shelves are adjustable.

Attach the Gridwall to the inside of the Pillars (as desired).

A) Insert the Hanging Bars into the openings in the Pillars. Push the rubber stoppers against the Pillars to keep the bars securely in place.

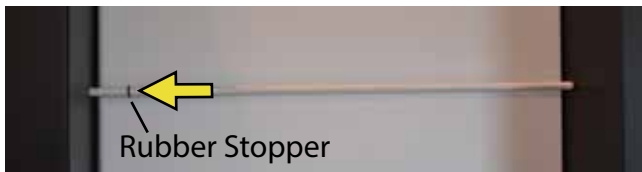

Hanging Bars installed



B) Use a hand clamp to temporarily hold the Gridwall Sections in place during assembly. Attach tie wraps to the Gridwall and Hanging Bars to secure the sections in place. Move the hand clamp to the next Gridwall Section and continue the Gridwall assembly as required.

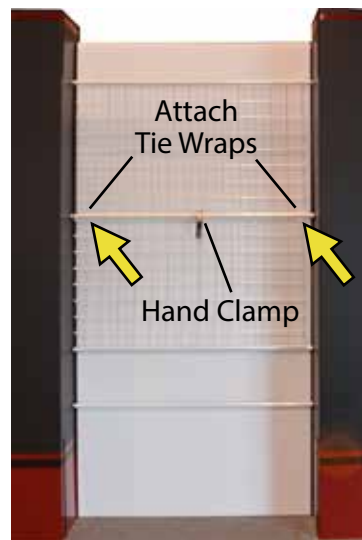

C) Use a hand clamp to temporarily hold the Gridwall Sections in place when the booth is dismantled. Cut the tie wraps to release the Gridwall Sections for packing and shipping.



Hand Clamp

View showing typical assembly of Gridwall Sections.

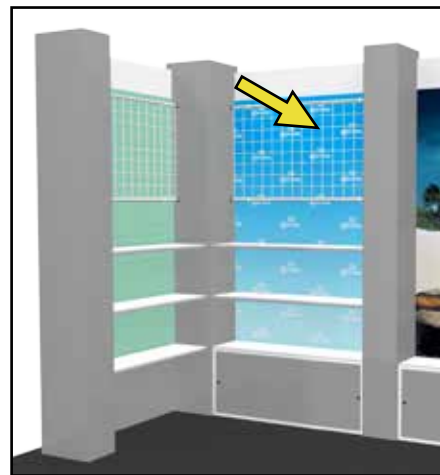

Gridwall options:

A) There are several options for installing the gridwall and shelves within each section. These include full shelving, a single gridwall panel, and a double gridwall panel.



Section with full shelves.
(Shelves are adjustable)



Section with (1) gridwall panel and shelves.



Section with (2) gridwall panels and bottom shelf.

B) White vinyl square patches are provided with the booth display to cover visible openings as desired.

View showing typical openings along the inside of a pillar.

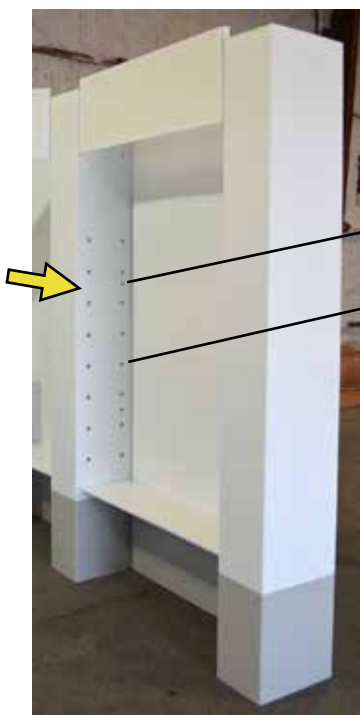

Opening for Hanging Bar

Opening for Shelf Support Bar

Assembly Instructions: InfiniLite 30-03

Assemble Signs and attach to Pillars with Velcro.

A) Unfold the Large Signs and Corner Signs.



B) Fold down the top sections of the Sign along the flutes to form a triangle and Velcro closed.

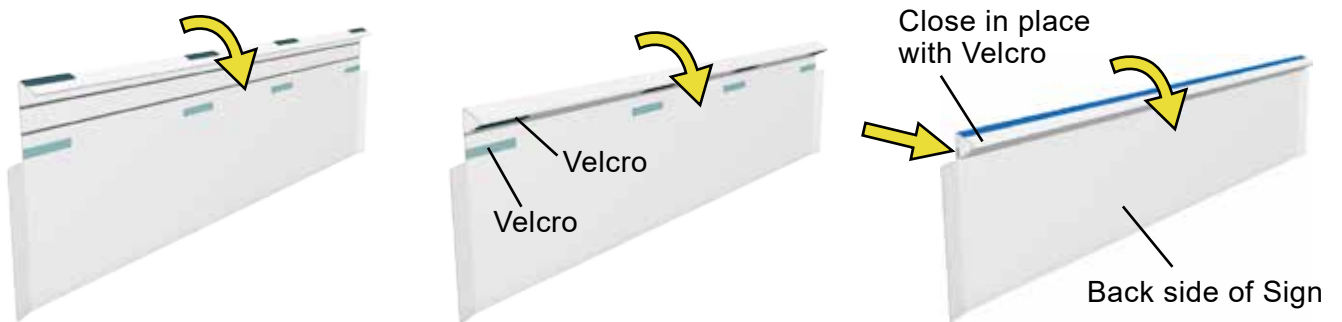

C) Attach Signs to Pillars with Velcro. Attach Posters to front of Signs with Velcro.

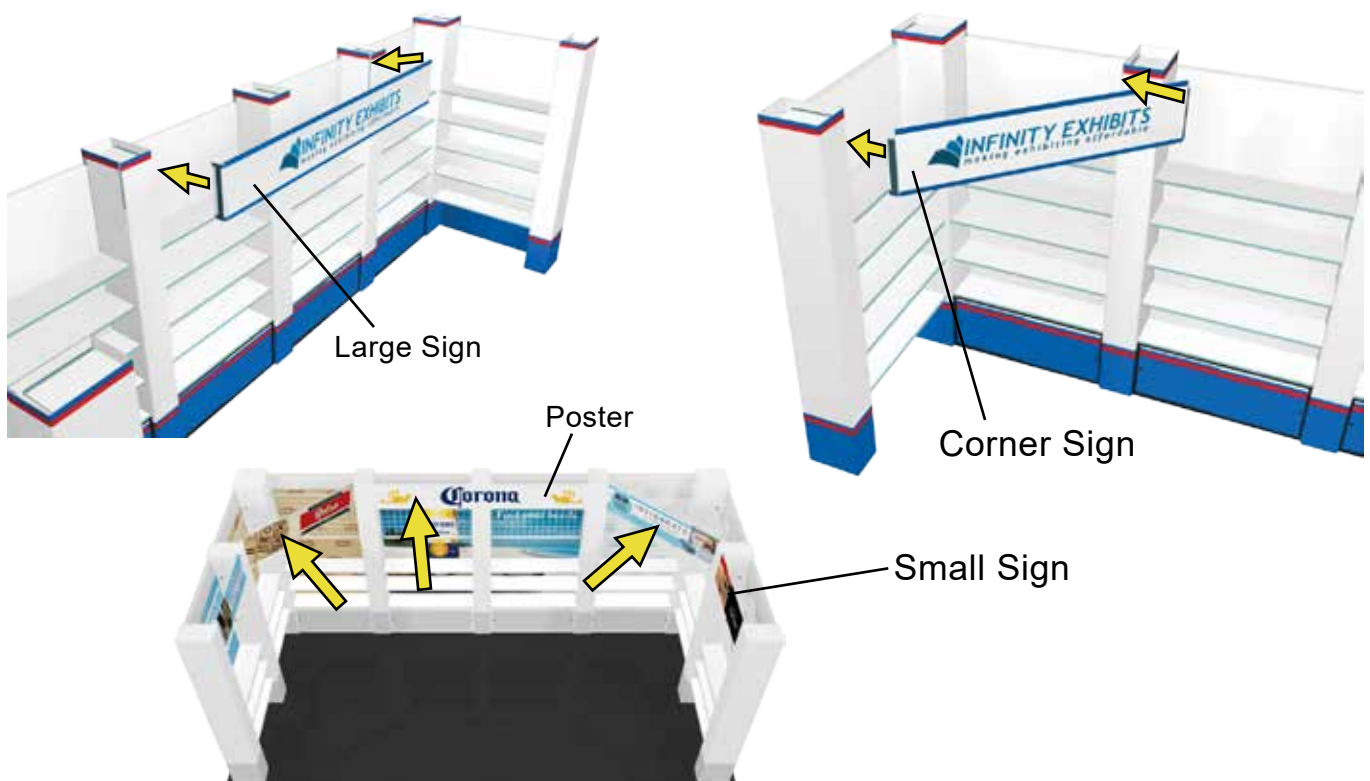

Attach the Stem Lights to the tops of the Pillars.

A) Place a wooden Light Support Stick on top of the proper Pillars as shown. (Use a ladder or step stool to access the top of the Pillar.) Secure the Stick to the back of the Pillar with a Binder Clip.

B) Attach the Stem Light to the front end of the Pillar and Support Stick by adjusting the thumbscrew on the back of the Stem Light. (**DO NOT** overtighten the thumbscrew. Overtightening the adjustment thumbscrew may damage the Pillar.)

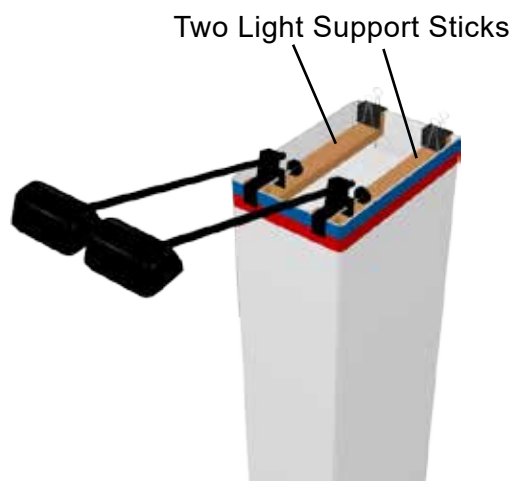
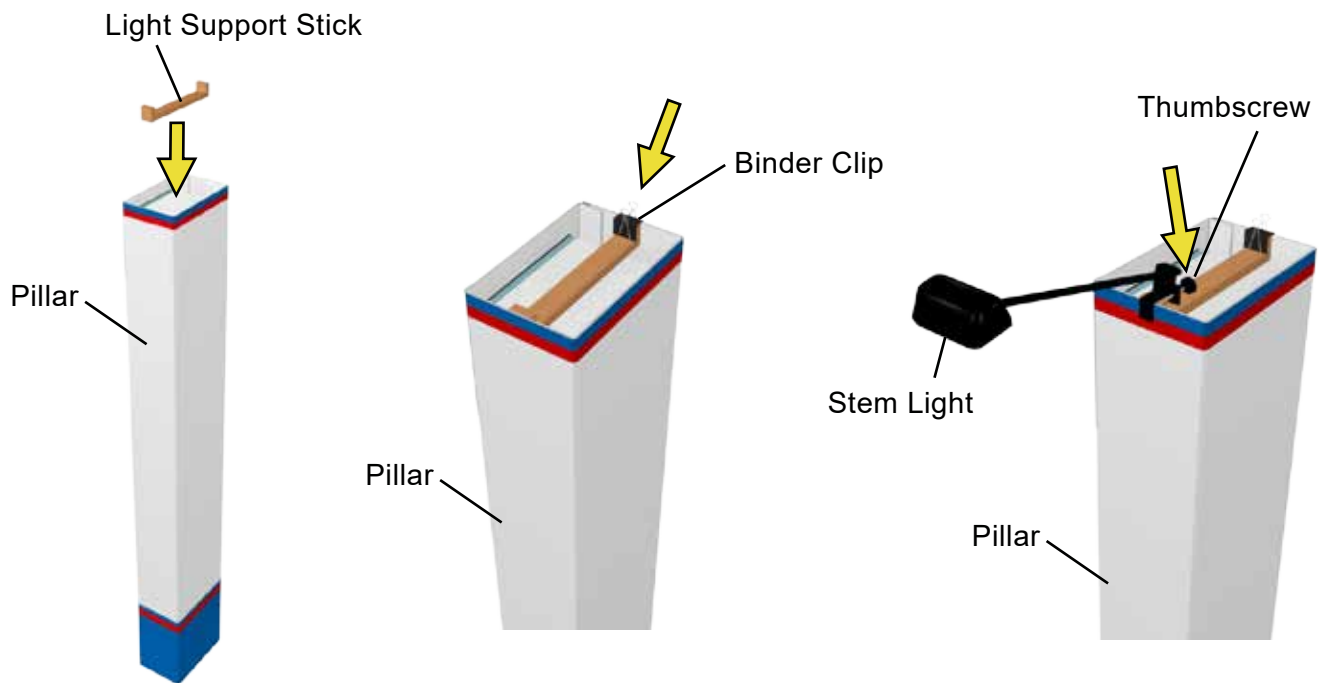

Two Stem Lights attached to top of Pillar.

Counter Assembly:

A) Connect the Counter Panels together with the 90° Channels. (Make sure that the Velcro is oriented along the top of the Panels for attaching the Counter Top.)

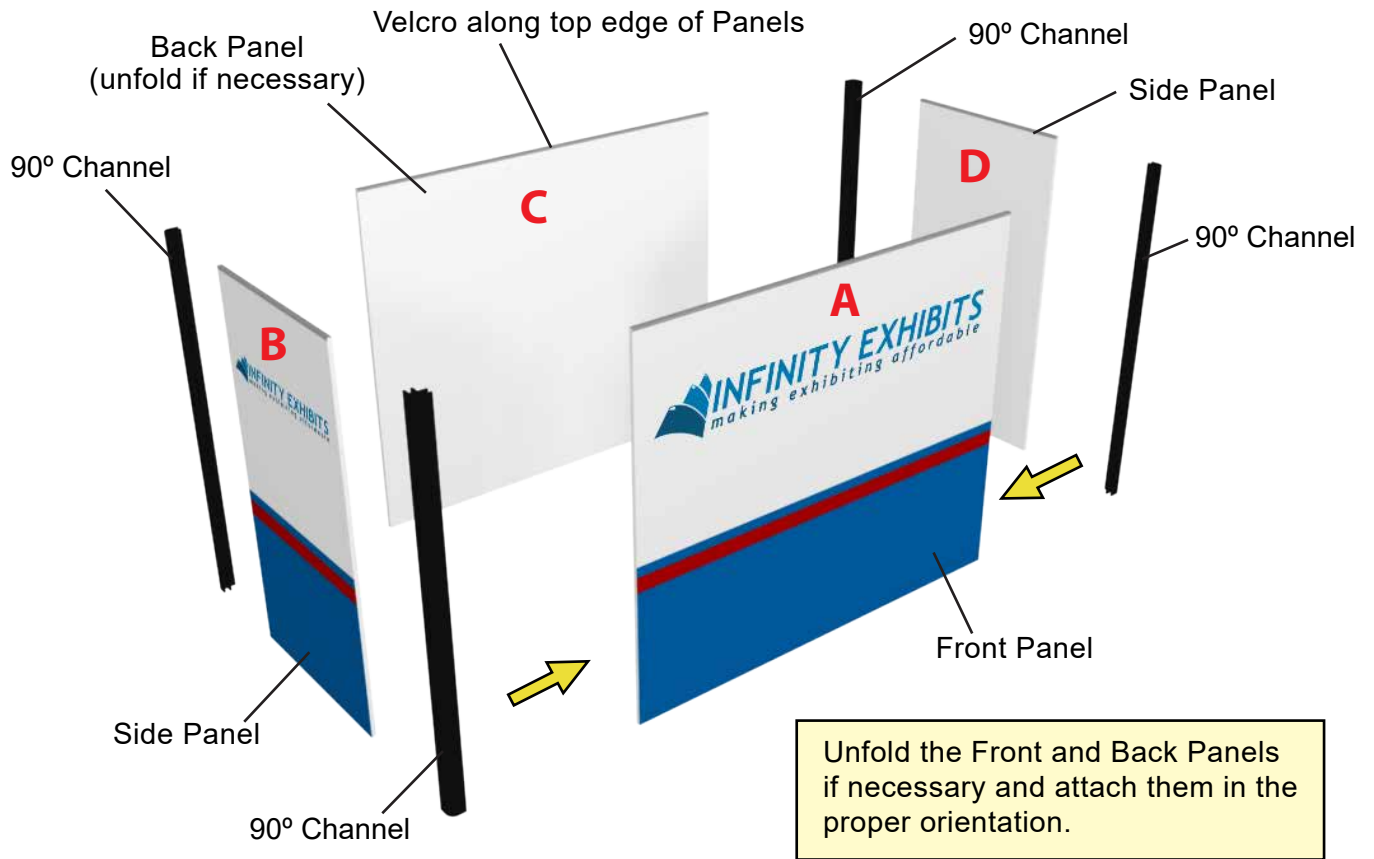

B) Attach the Counter Top to the tops of the Panels with Velcro.

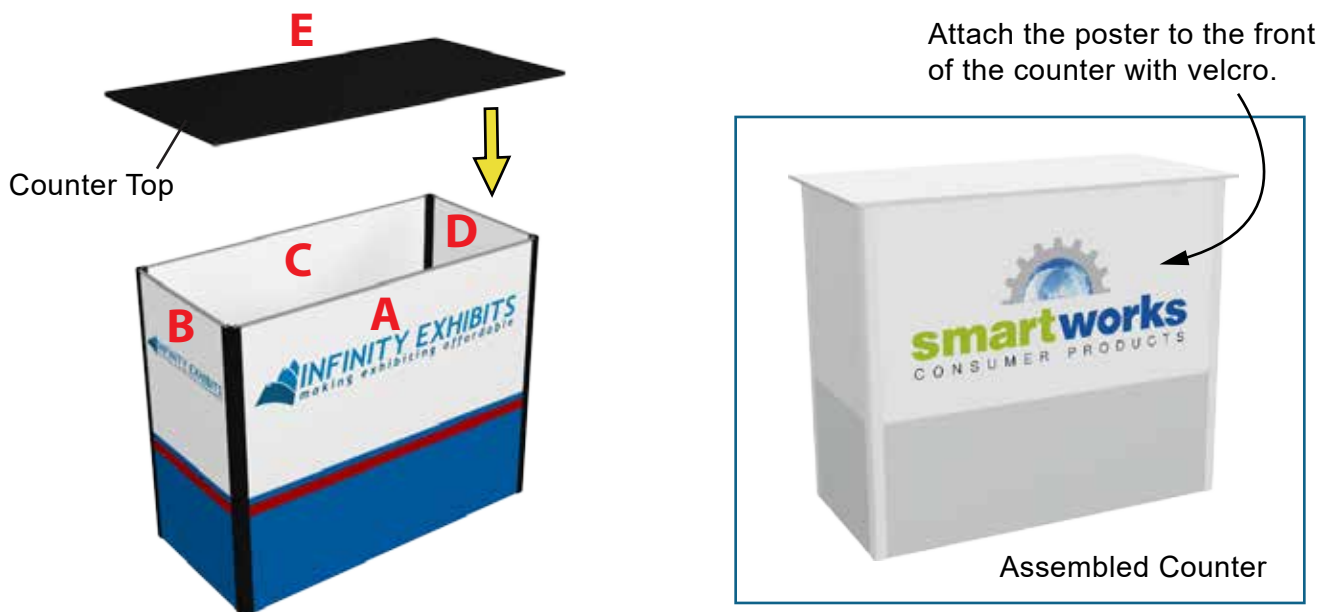

Tub Layout

After disassembling the booth, organize the display components and pack them into the Shipping Tubs:



10' x 30' Display Booth



(2) Shipping Tubs

Tub

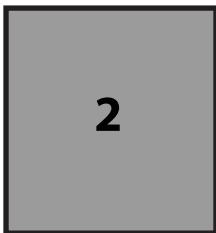
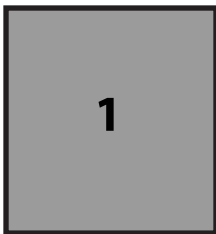

Booth Components

- | | |
|-----------------------|-------------------------|
| 1) Pillars | 11) Counter Panels |
| 2) Pillar Backs | 12) Counter Components |
| 3) Tops & Bottoms | 13) Shelves |
| 4) Signs | 14) Stem Lights |
| 5) Sign Posters | 15) Wooden Light Sticks |
| 6) Sliding Storages | 16) Extension Cords |
| 7) Shelf Support Bars | 17) Powers Strips |
| 8) Gridwall Sections | 18) Wall Panels |
| 9) Hanging Bars | 19) Misc. Hardware |
| 10) Counter Top | |

NOTE: Pack the heavier components towards the bottom of the Tub.