



**Steps to Assemble the InfiniLite Multi Section Exhibit Booth:**

- Step 1:** Assemble Pillars and Corner Pillars.
- Step 2:** Place Pillars upright in their proper order.
- Step 3:** Attach Wall Panels to Pillars.
- Step 4:** Install Storage Doors.
- Step 5:** Install Shelf Support Bars.
- Step 6:** Attach Shelves to Shelf Support Bars with Velcro.
- Step 7:** Attach Large Center Sign to front of Display with Velcro.
- Step 8:** Attach Corner Signs to Pillars with Velcro.
- Step 9:** Attach Stem Lights to Pillars.

**Assemble Pillars.**

A) Unfold the Pillar Panels with the front sides facing downward.

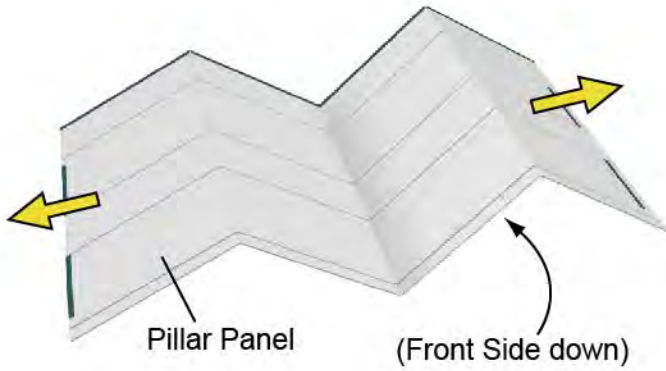

B) Attach Top and Bottom Supports to the back of the Pillars with Velcro.

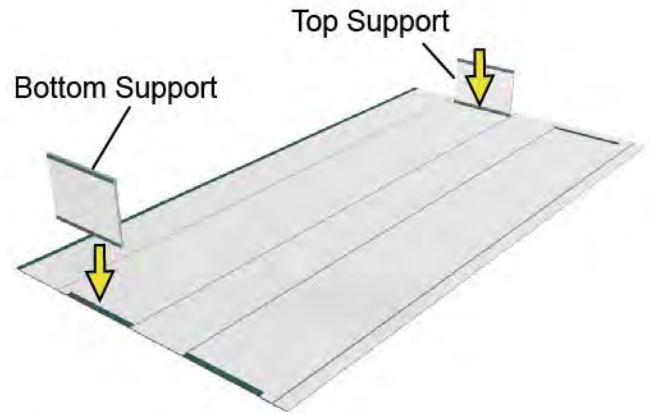

C) Fold Pillar around the Supports and attach with Velcro.

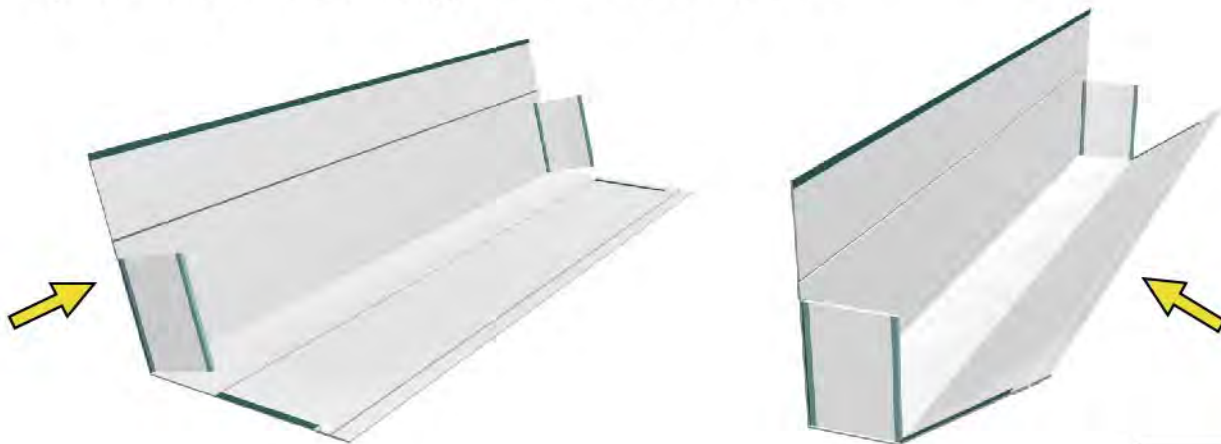

D) Close the Pillar using the Velcro strips along the Pillar edges.

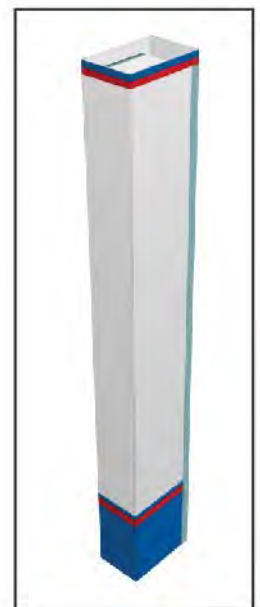
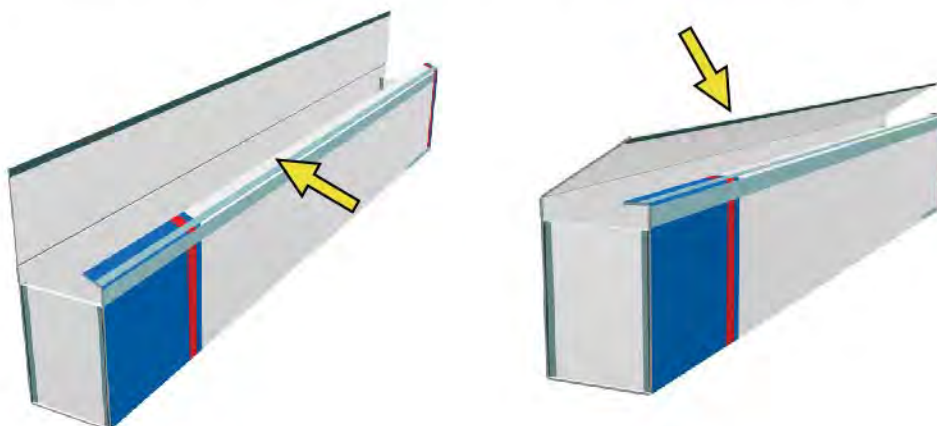

**Assembled Pillar**

## Assembly Instructions:

## 20' Multi 7 Section Shelf Display

### Assemble Corner Pillars.

E) Unfold the Corner Pillar Panels with the front sides facing downward.

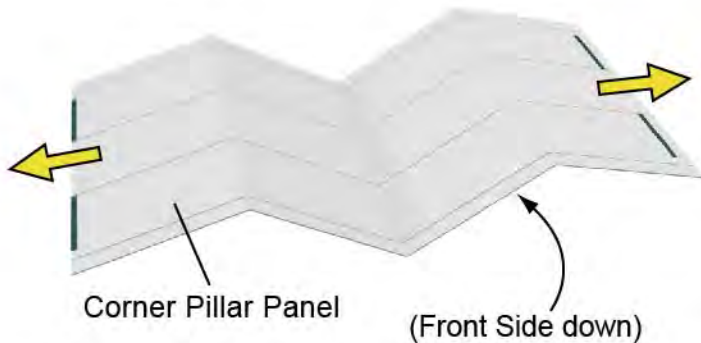

F) Attach Top and Bottom Supports to the back of the Corner Pillars with Velcro.

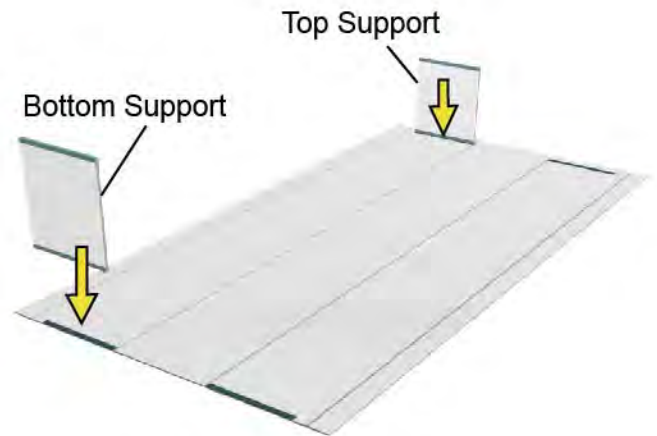

G) Fold the Corner Pillar around the Supports and attach with Velcro.



H) Attach the Back Cover to the bottom half of the Corner Pillar with Velcro; unfold the Back Cover; then attach the remaining Back Cover to the upper half of the Corner Pillar.

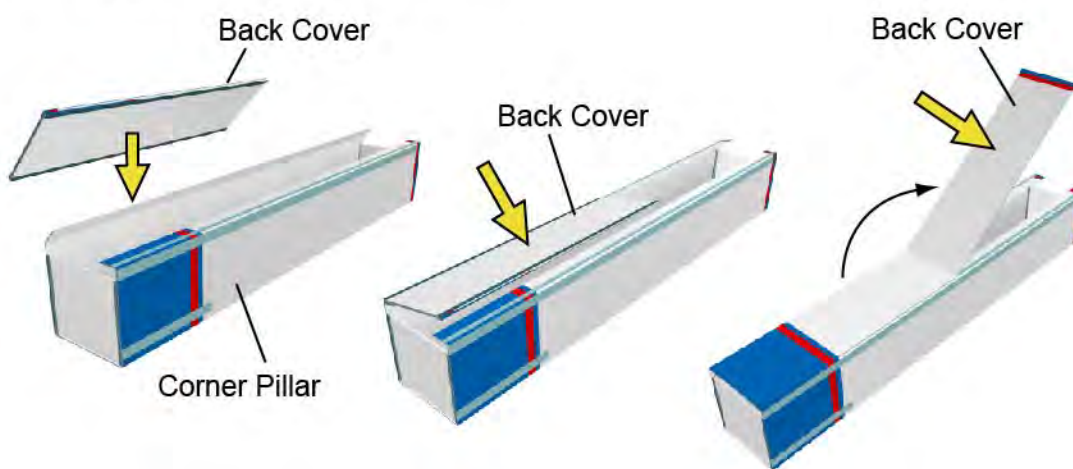

## Assembly Instructions: 20' Multi 7 Section Shelf Display

The following Floor Plan identifies the locations of the Booth Components:

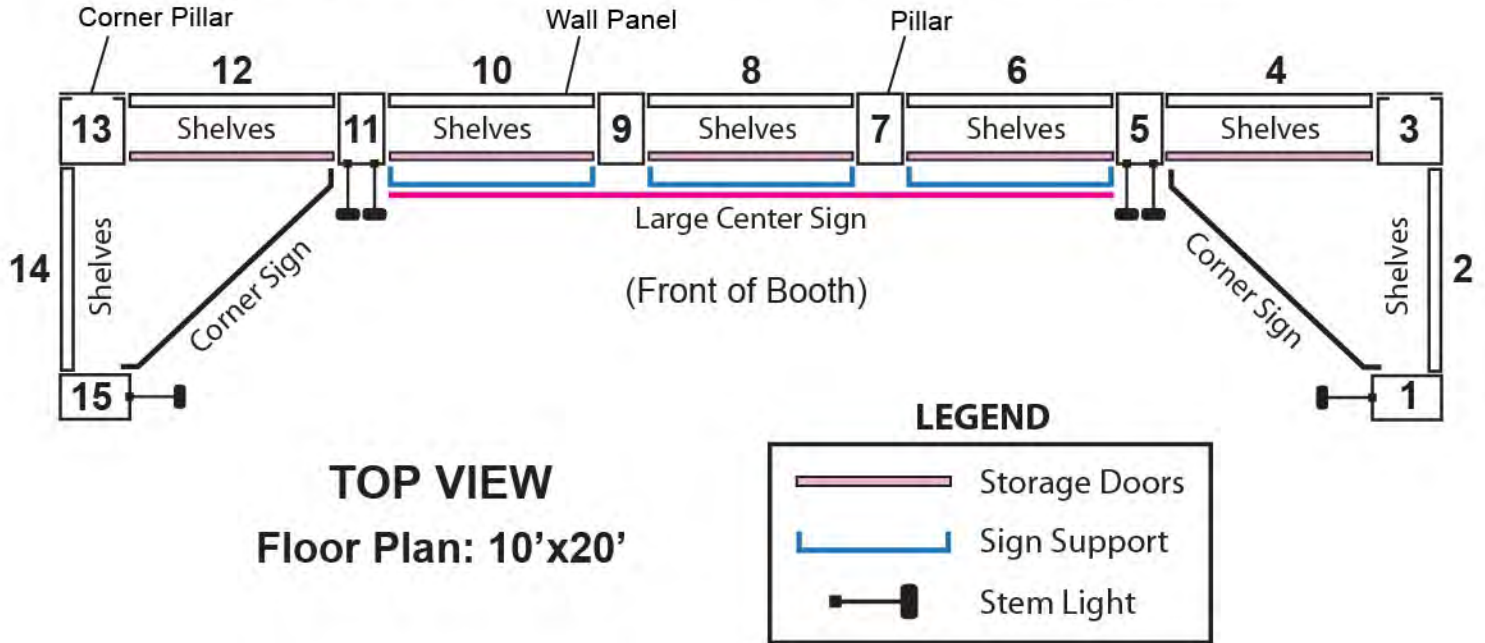

Place the assembled Pillars and Corner Pillars upright in their proper order and assigned locations as numbered and indicated on the Floor Plan.

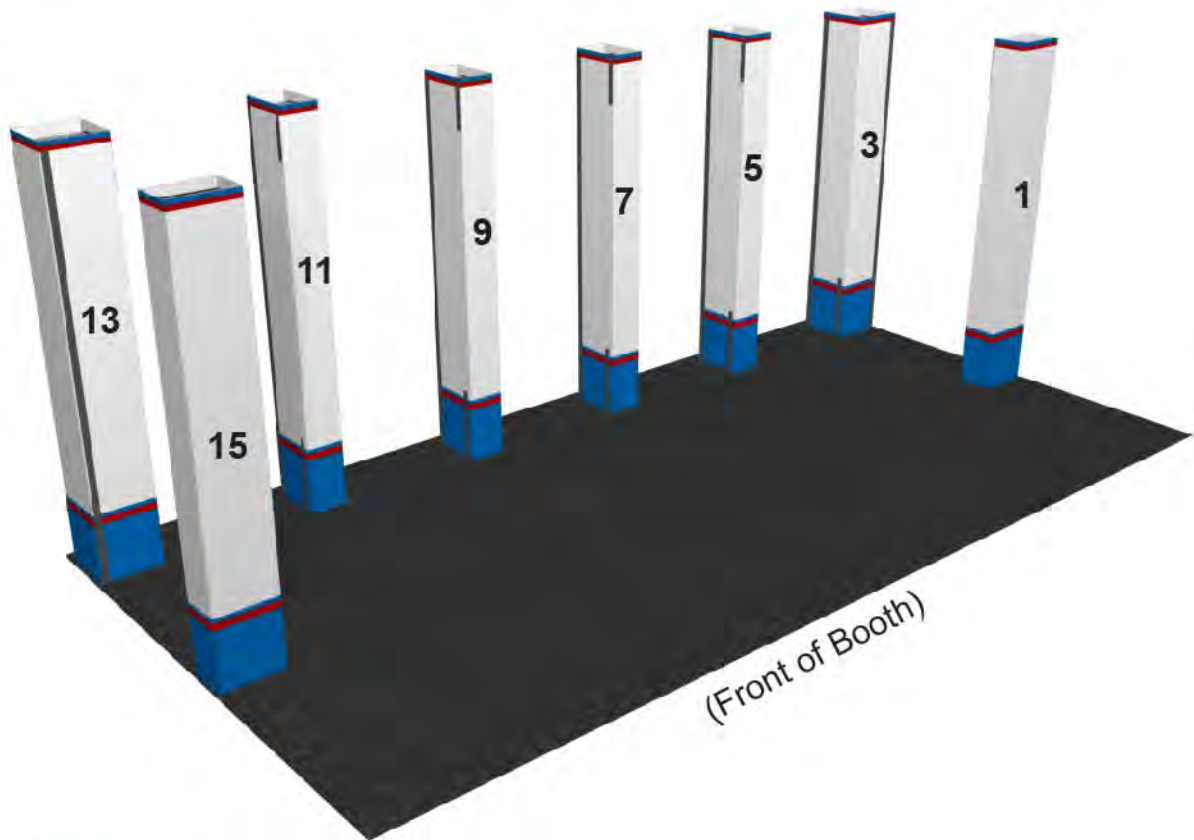

**Attach Wall Panels to Pillars.**

A) Unfold the bottom half of the Wall Panel, hold upright and attach to the side of the Pillar with Velcro. (Make sure that the Pillar and Wall Panel are **flat** on the floor surface when attaching and that the accent stripes are aligned with each other.) Begin assembly from either the left or right side of the Booth.

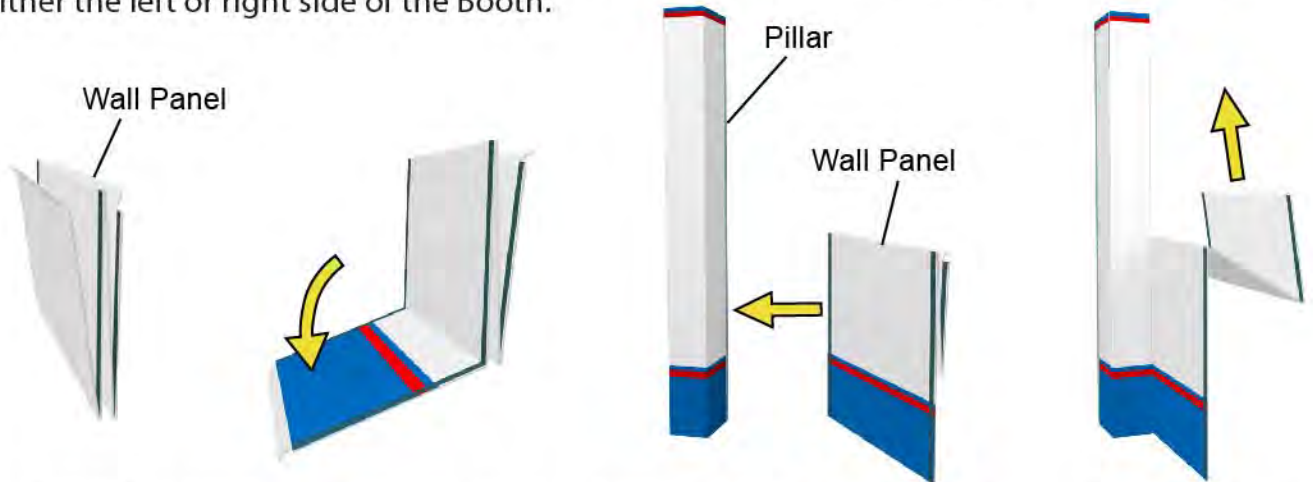

B) Unfold the top half of the Wall Panel and attach it to the top half of the Pillar matching the Velcro strips along the edges. Rotate the Wall Panel into position. Attach the next Pillar to the Wall Panel so that it is flat against the front face of the Wall Panel. Rotate the Pillar into position.

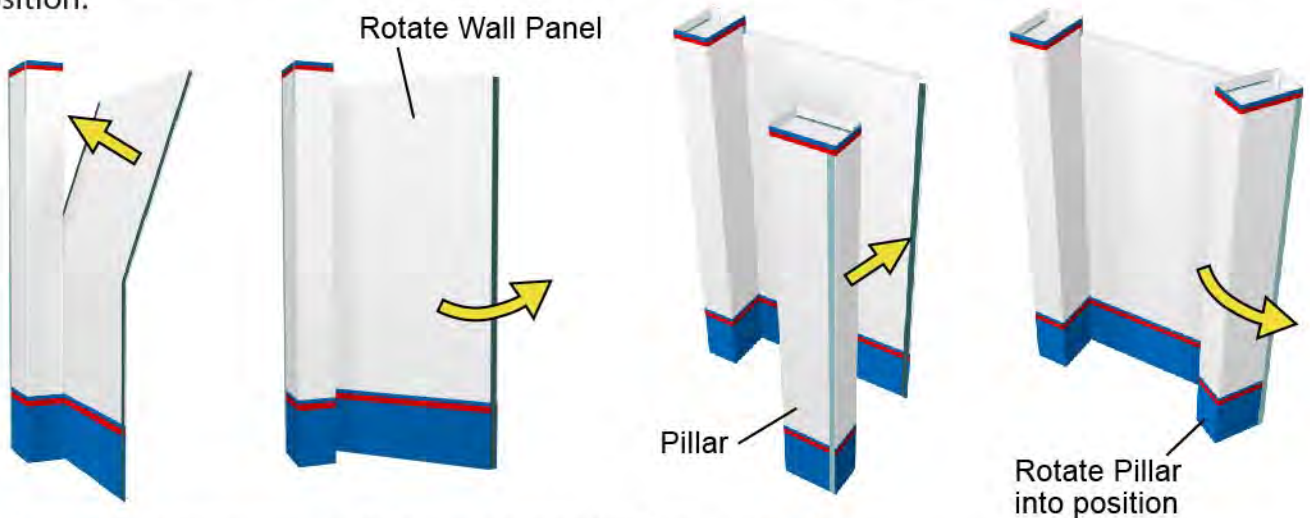

C) Repeat this process with the remaining Wall Panels and Pillars.



## Assembly Instructions:

## 20' Multi 7 Section Shelf Display

Install Storage Doors. (Attach Storage Doors to Pillars with Velcro.)



### Install Shelf Support Bars.

A) Insert the shelf support bars into their designated openings in the Pillars with the **back bars** first, installing from the bottom upward. Then install the **front bars** from the bottom upward.

**Make sure that the Velcro on the bars is facing up to attach the shelves and that the full portion of the vinyl covering is facing forward (if vinyl has been applied to the front of the shelf support bar).**

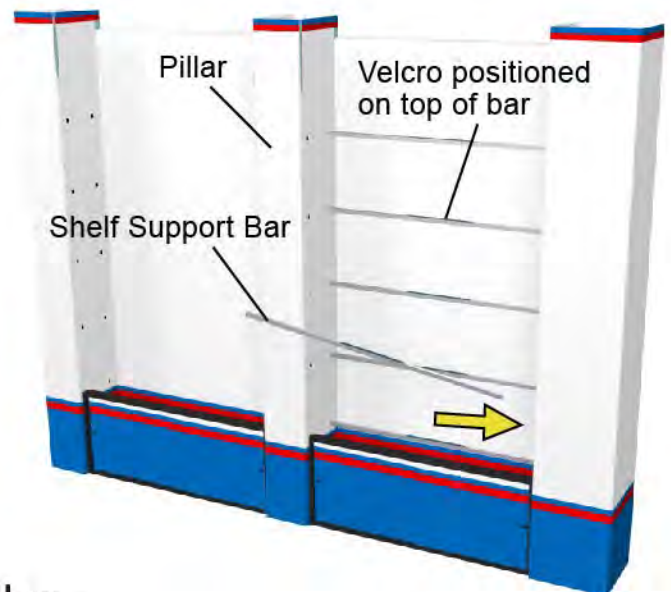

### Attach Shelves to Shelf Support Bars with Velcro.

A) Place the Shelves on top of the Shelf Support Bars and attach with Velcro.

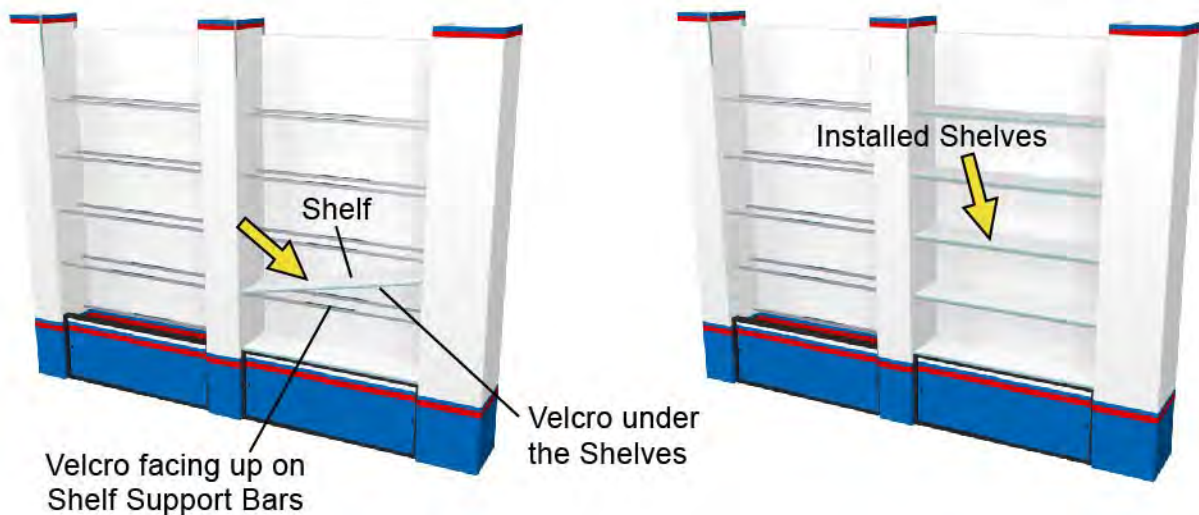

## Assembly Instructions:

## 20' Multi 7 Section Shelf Display

Attach the Large Center Sign to the front of the Display with Velcro.

A) Attach the three Sign Supports to the inner Pillars with Velcro.

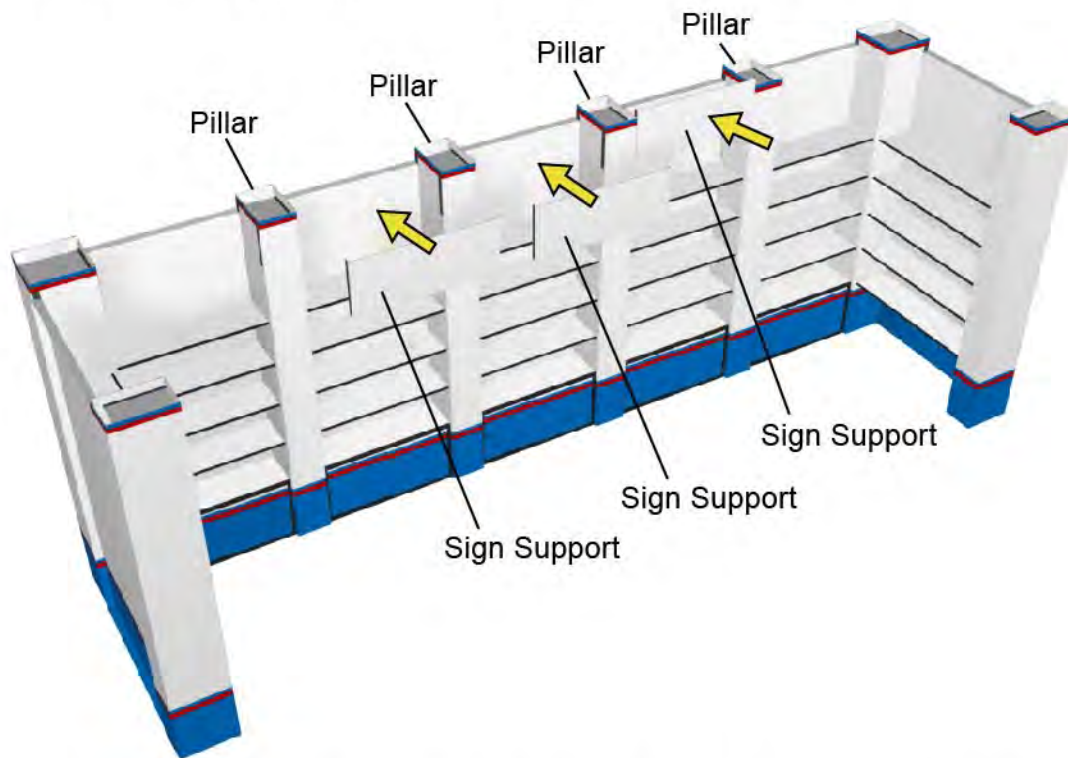

B) Unroll the Large Center Sign and attach it to the Sign Supports and middle Pillars with Velcro.

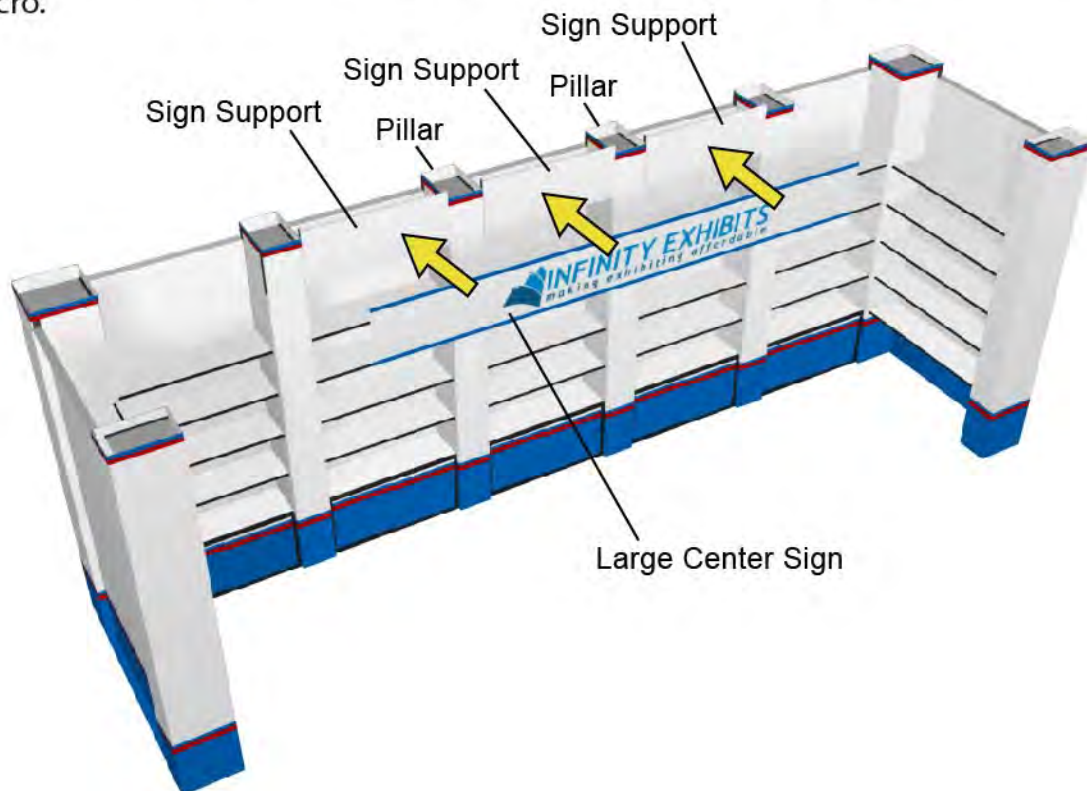

## Assembly Instructions:

## 20' Multi 7 Section Shelf Display

### Assemble Corner Signs and attach to Pillars with Velcro.

A) Fold down the top sections of the Signs along the flutes to form a triangle and Velcro closed.

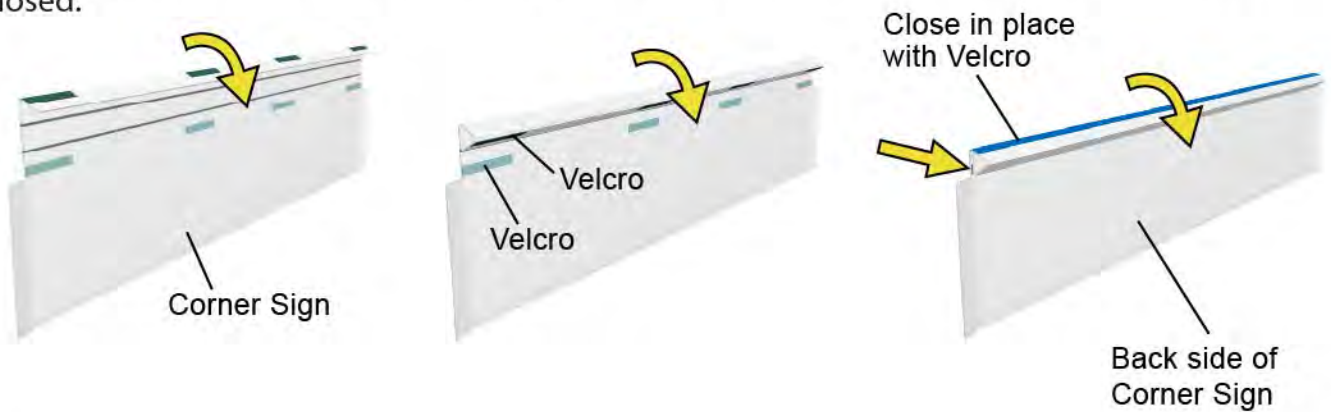

B) Attach Corner Signs to Pillars with Velcro.

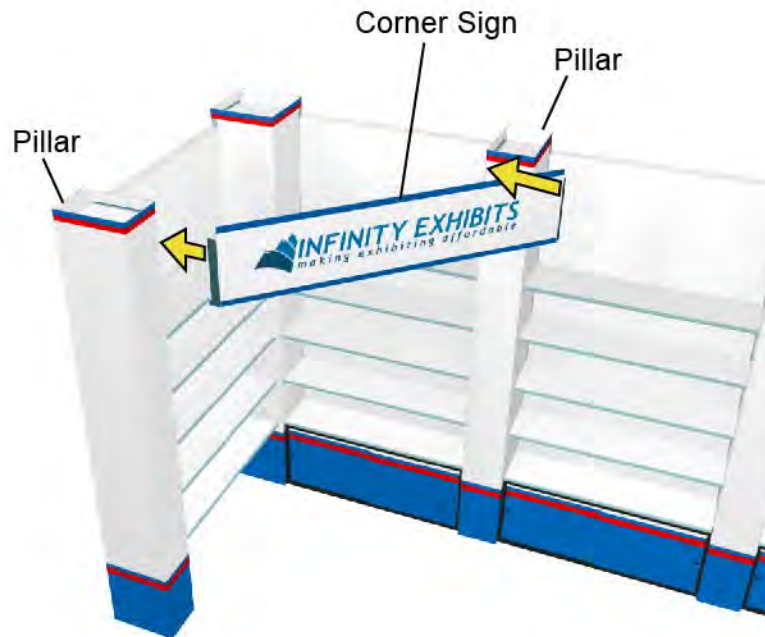



**Attach the Stem Lights to the tops of the Pillars.**

A) Place a wooden Light Support Stick on top of the proper Pillars as shown. (Use a ladder or step stool to access the top of the Pillar.) Secure the Stick to the back of the Pillar with a Binder Clip.

B) Attach the Stem Light to the front end of the Pillar and Support Stick by adjusting the thumbscrew on the back of the Stem Light. (**DO NOT** overtighten the thumbscrew. Overtightening the adjustment thumbscrew may damage the Pillar.)

