



## Display Setup Instructions



10' x 20' Display Booth



Floor Plan: 10'x 20'

### Steps to Assemble the InfiniLite Multi Section Exhibit Booth:

- Step 1: Assemble the Pillars, Corner Pillars and Short Pillars.
- Step 2: Place Pillars upright in their proper order and locations.
- Step 3: Attach Wall Panels to Pillars.
- Step 4: Install Shelf Support Bars into sides of Pillars.
- Step 5: Install Storage Doors.
- Step 6: Attach Shelves to Shelf Support Bars with Velcro.
- Step 7: Install the Grid wall Sections into the sides of the Pillars.
- Step 8: Attach Signs to Pillars with Velcro.
- Step 9: Attach Stem Lights to tops of Pillars.
- Step 10: Assemble the Counter and place it within the booth area.

Click on the link below for an instructional video:

<http://youtu.be/-INxoiV-fG4>

Assemble the Pillars.

A) Unfold the Pillar Panels with the front sides facing downward.

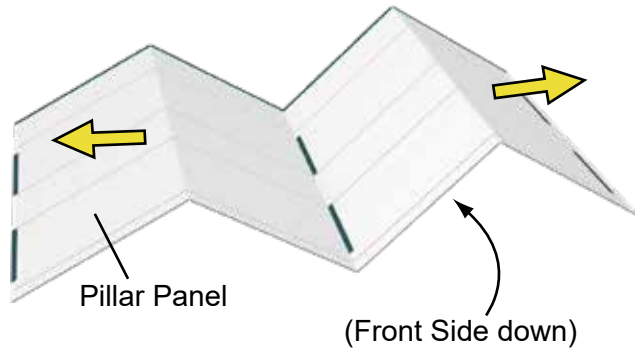

B) Attach Top and Bottom Supports to the back of the Pillars with Velcro.

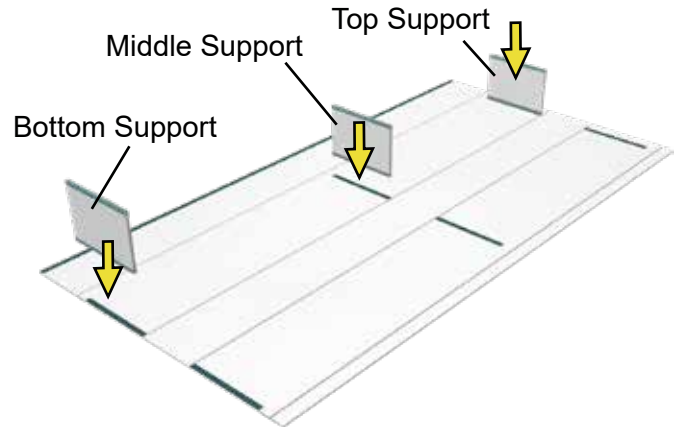

C) Fold Pillar around the Supports and attach with Velcro.

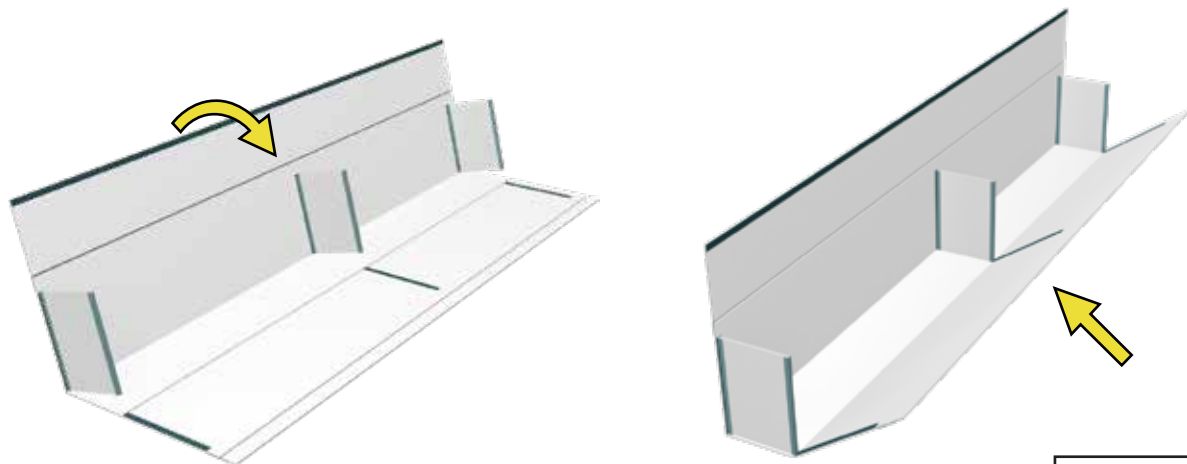

D) Close the Pillar using the Velcro strips along the Pillar edges.

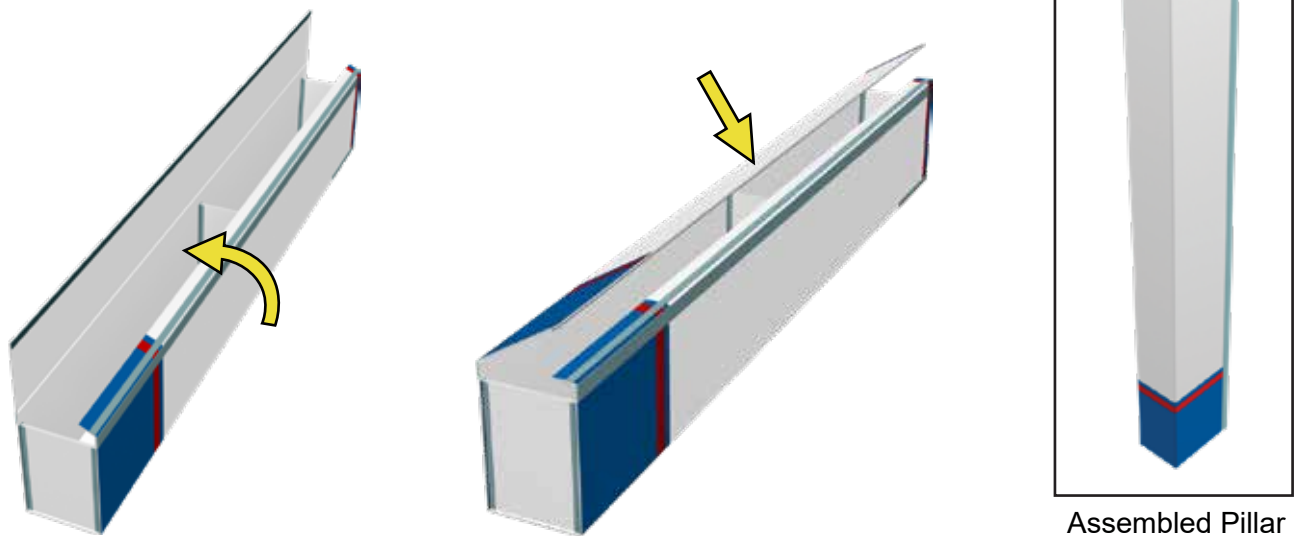

Assemble the Corner Pillars.

A) Unfold the Corner Pillar Panels with the front sides facing downward.

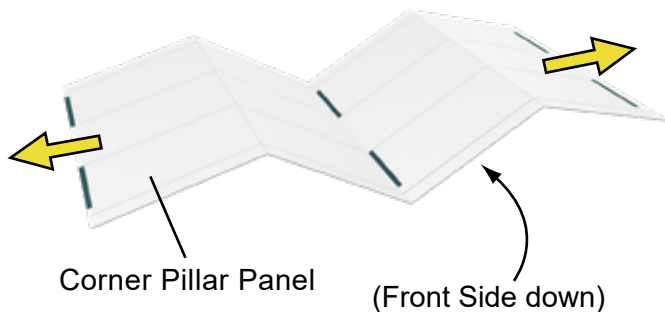

B) Attach the Top, Middle and Bottom Supports to the back of the Panels with Velcro.

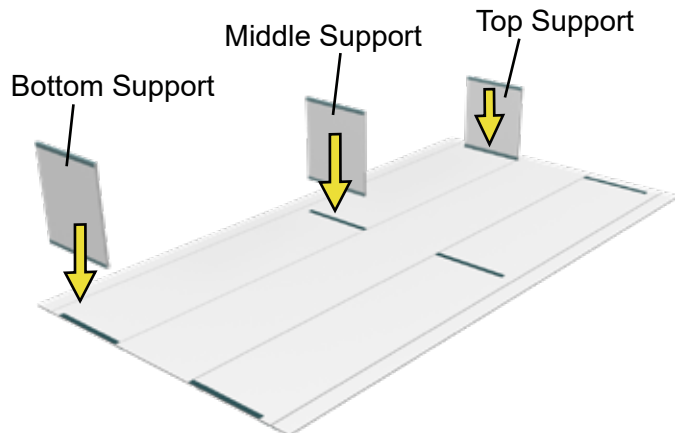

C) Fold the Corner Pillar around the Supports and attach with Velcro.

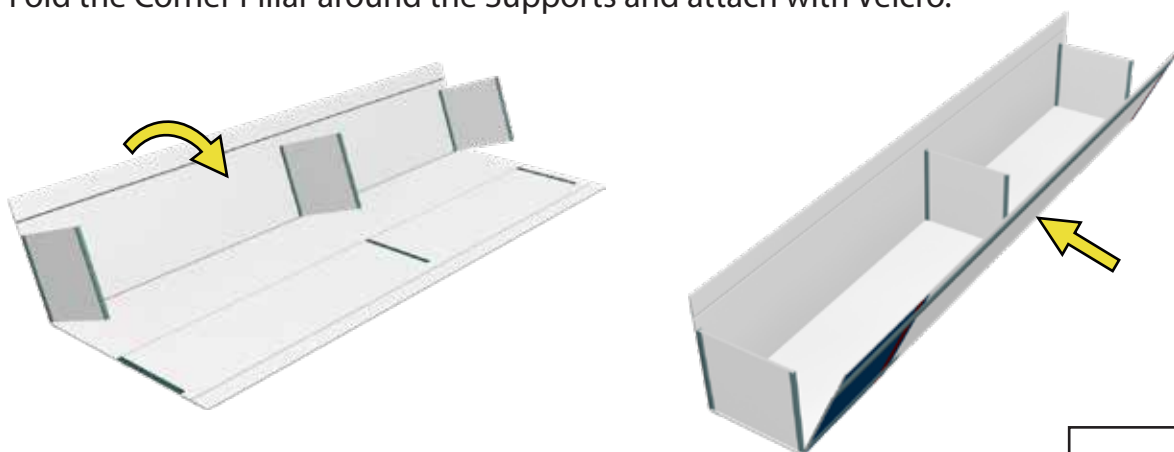

D) Attach the Back Cover to the bottom half of the Corner Pillar with Velcro; unfold the Back Cover; then attach the remaining Back Cover to the upper half of the Corner Pillar.

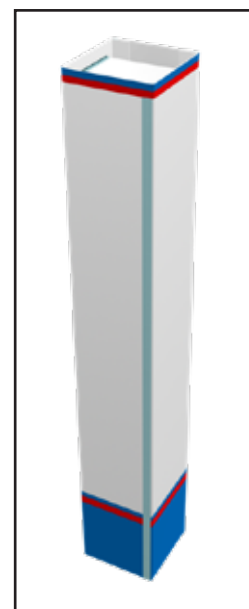
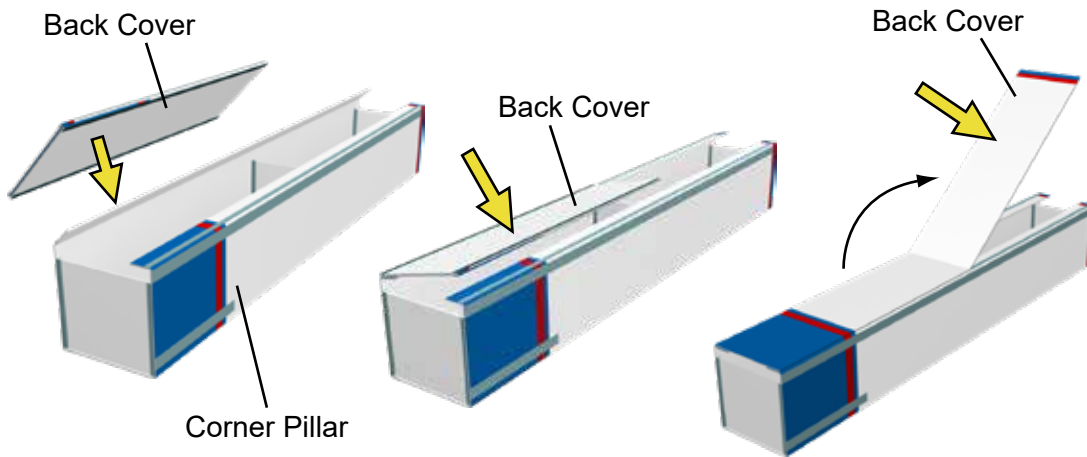

Assembled Corner Pillar

Assemble Short Pillars.

A) Unfold the Short Pillar Panels with the front sides facing downward.

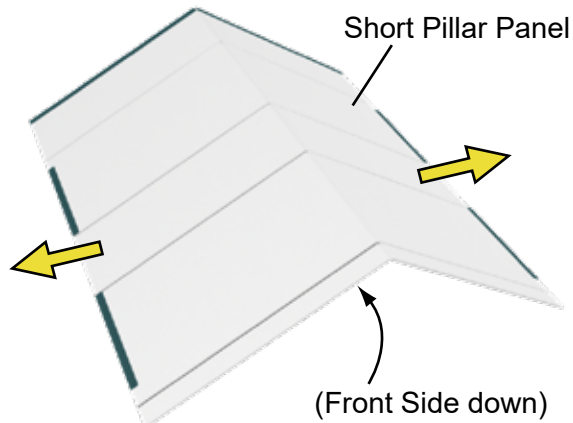

B) Attach Top and Bottom Supports to the back of the Short Pillars with Velcro.

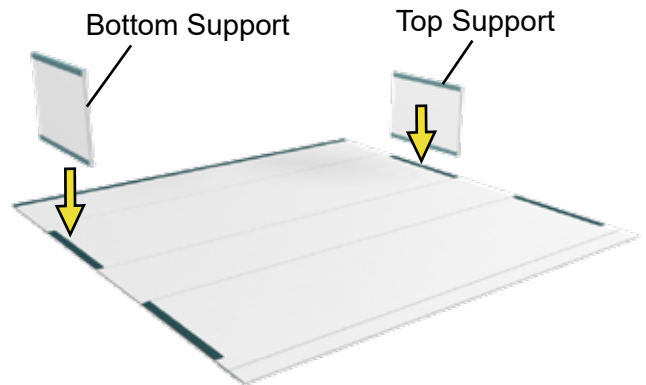

C) Fold Short Pillar around the Top and Bottom Supports and attach with Velcro.

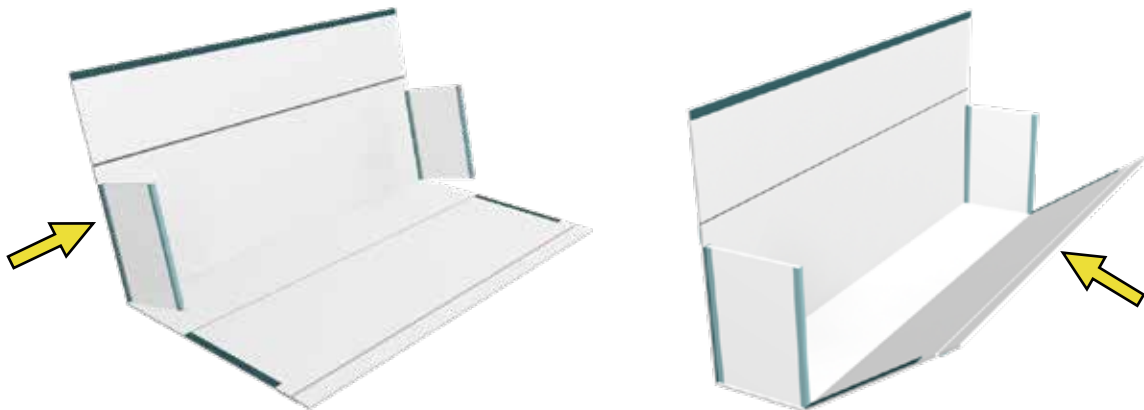

D) Close the Short Pillar using the Velcro strips along the edges.

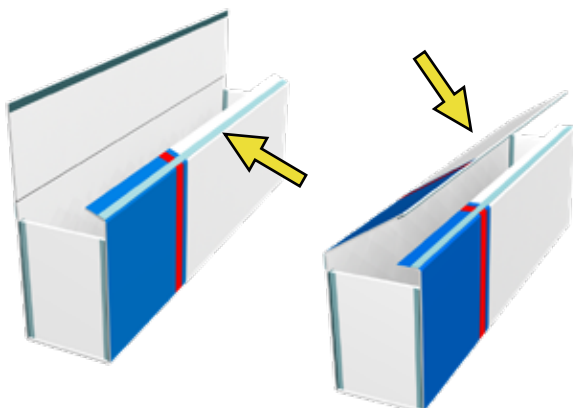

E) Attach Pillar Top to the Short Pillar with Velcro.

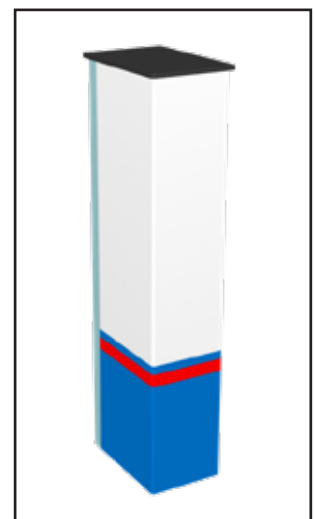





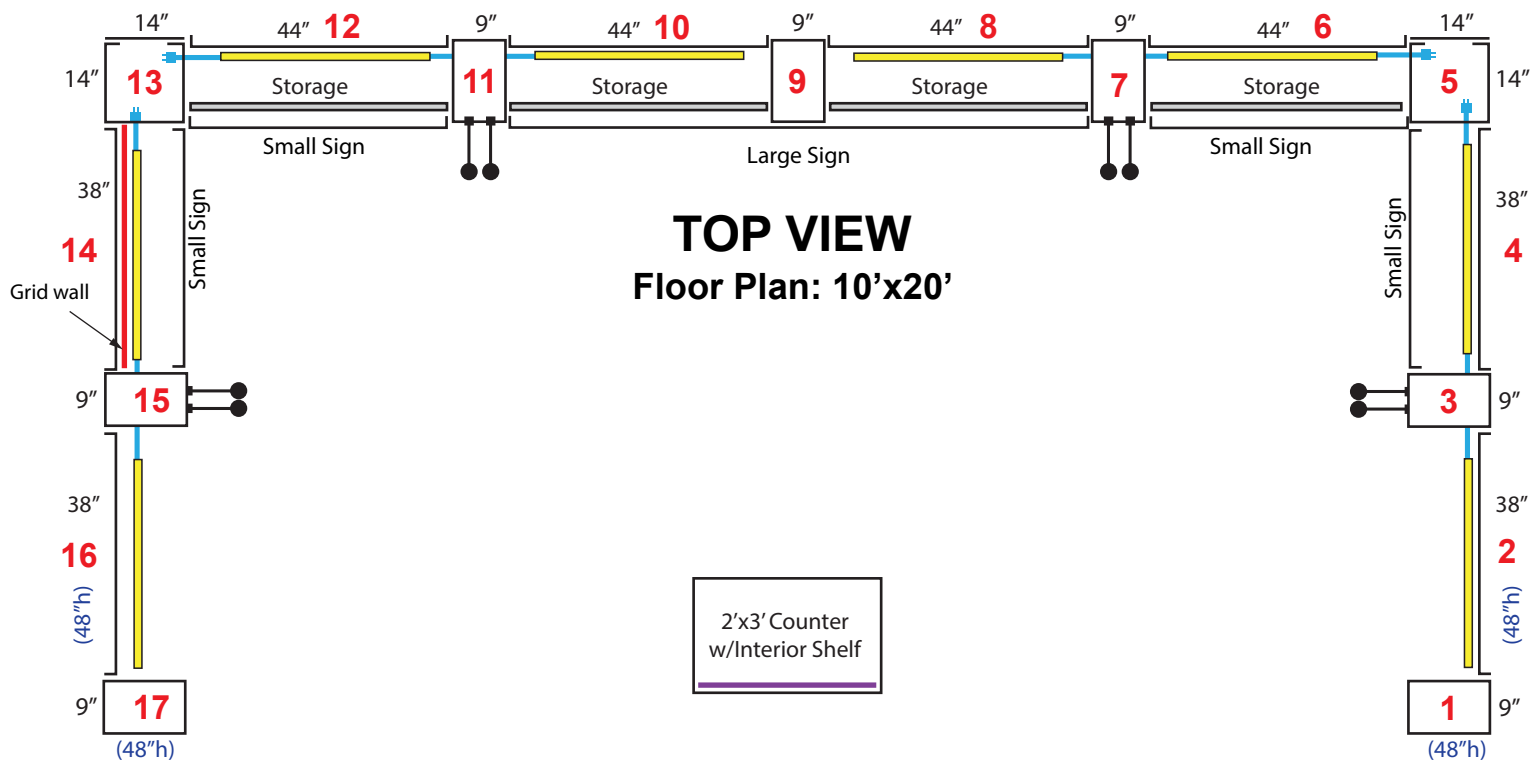

Assembled Short Pillar

# Assembly Instructions: InfiniLite 20-13

The following Floor Plan identifies the locations of the Booth Components when the Display is assembled as a 10'x20' Display Booth:



## LEGEND

	Storage Doors
	Grid wall
	Pillar
	Wall Panel
	LED Light Bar
	Stem Light

## Assembly Instructions:

## InfiniLite 20-13

Place the assembled Pillars and Corner Pillars upright in their proper order and assigned locations as numbered and indicated on the Floor Plan.

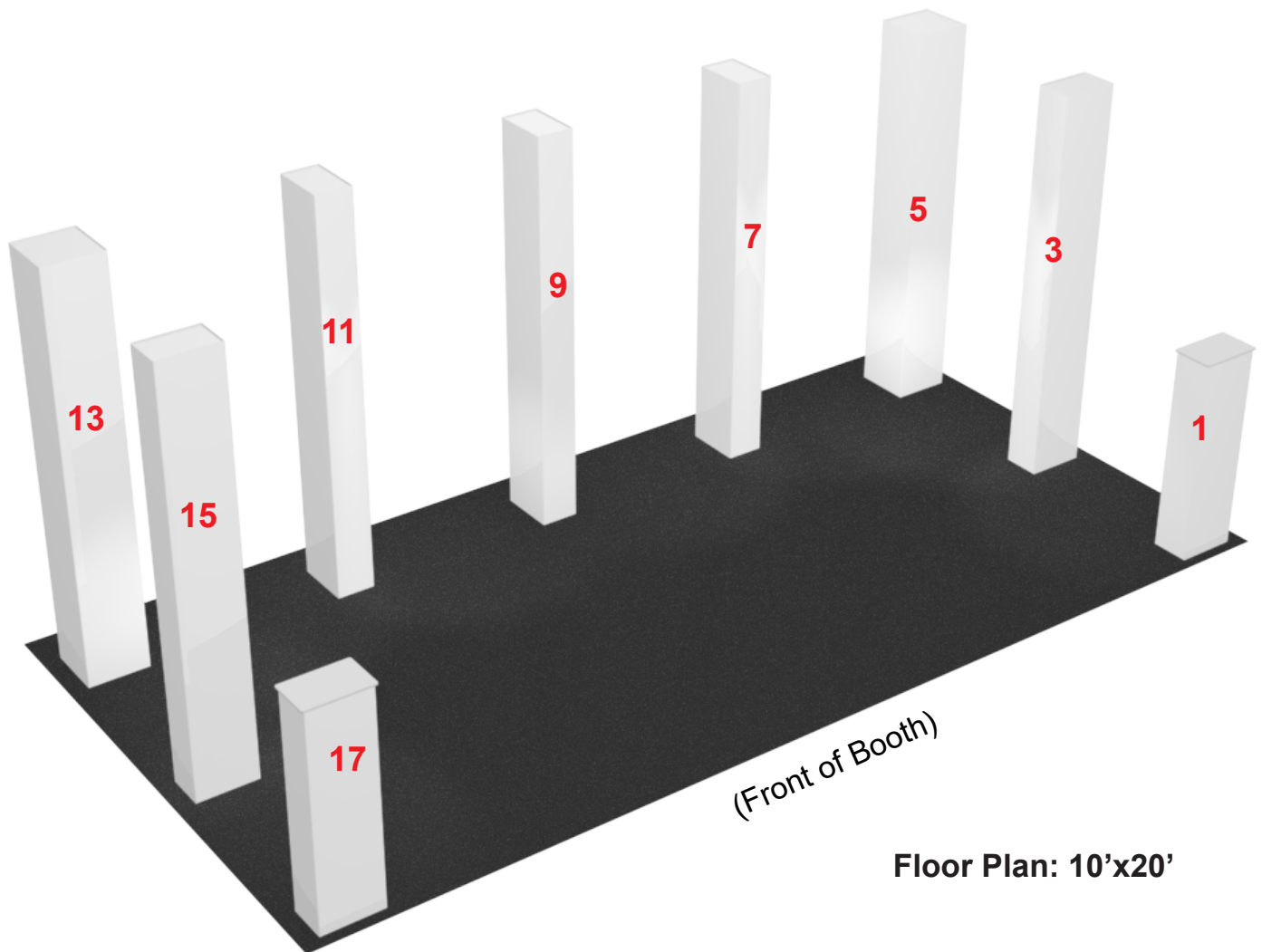



Attach Wall Panels to Pillars.

A) Unfold the bottom half of the Wall Panel, hold upright and attach to the side of the Pillar with Velcro. (Make sure that the Pillar and Wall Panel are flat on the floor surface when attaching and that the accent stripes are aligned with each other.) Begin assembly from either the left or right side of the Booth.

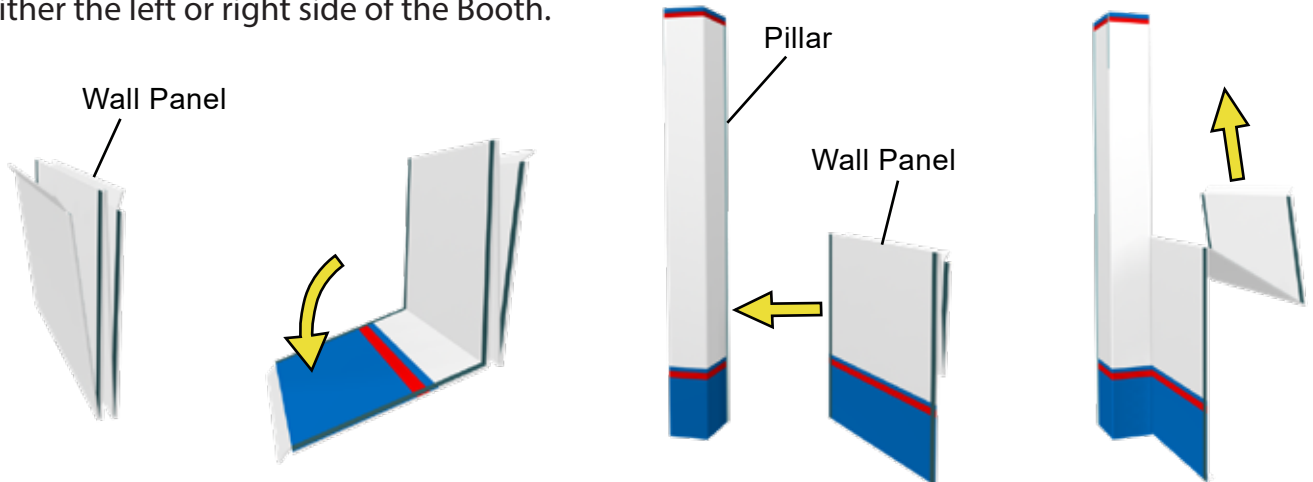

B) Unfold the top half of the Wall Panel and attach it to the top half of the Pillar matching the Velcro strips along the edges. Rotate the Wall Panel into position. Attach the next Pillar to the Wall Panel so that it is flat against the front face of the Wall Panel. Rotate the Pillar into position.

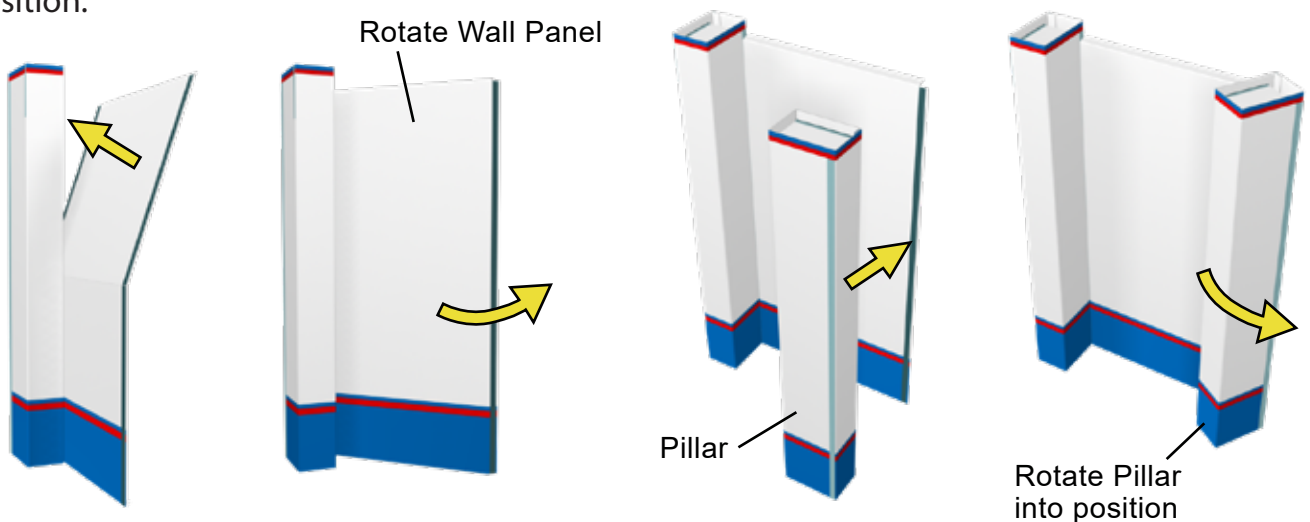

C) Repeat this process with the remaining Wall Panels and Pillars.





**Attach Short Wall Panel to Pillars.**

A) Unfold the Short Wall Panel, hold upright, and attach to Pillar with Velcro. (Make sure that the bottoms of the Pillar and Short Wall Panel are flat against the floor when attaching and that the accent stripes are aligned with each other.)

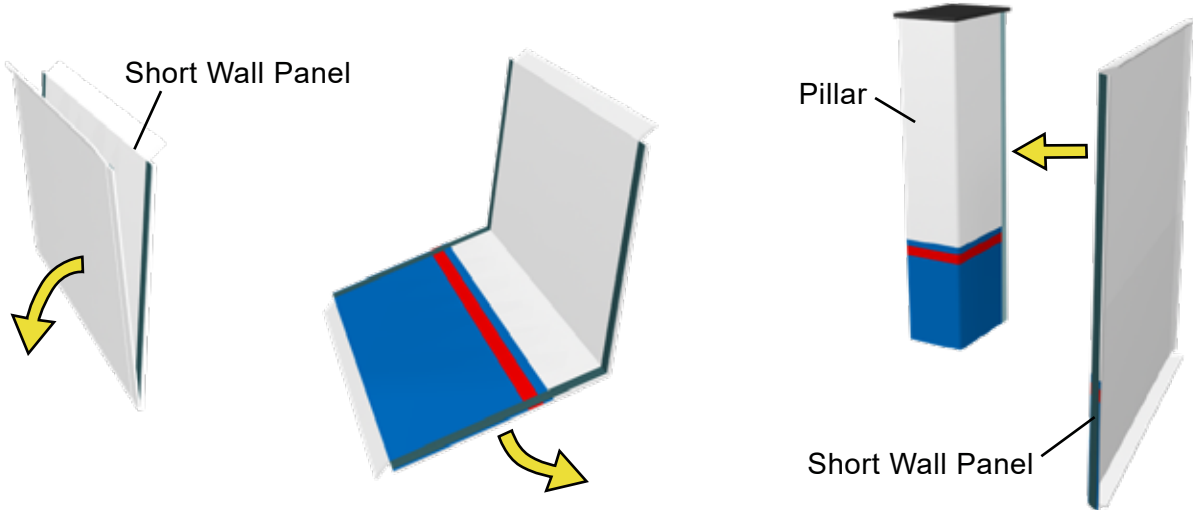

B) Rotate the Short Wall Panel into position. Attach the Short Pillar to the Short Wall Panel so that it is flat against the front face of the Short Wall Panel. Rotate the Pillar into position.

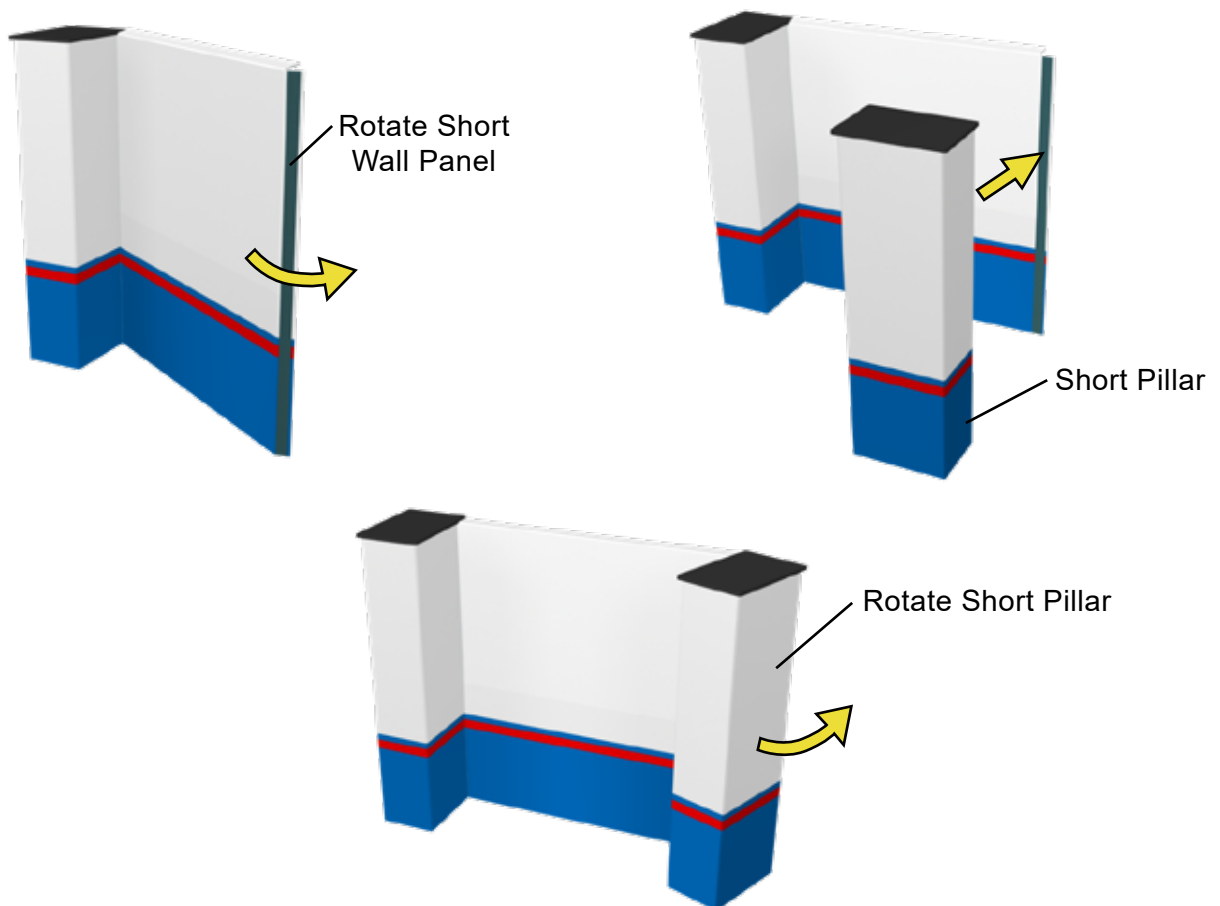

## Assembly Instructions:

## InfiniLite 20-13

### Install Shelf Support Bars.

A) Insert the shelf support bars into the designated openings in the Pillars.

**Make sure that the Velcro on the bars is facing up to attach the shelf.**

**NOTE:** Images on this page show typical installation of Shelf Support Bars, Storage Doors, and Shelves.

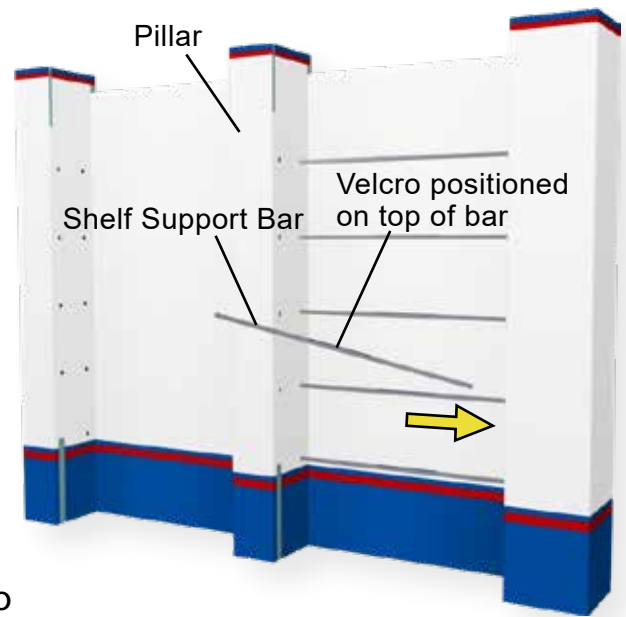

### Install Storage Doors. (Attach Storage Doors to the inside of the Pillars with Velcro.)



### Attach Shelves to Shelf Support Bars and top of Storage Doors with Velcro after the Fluorescent Lights have been installed. (See following pages for light installation.)

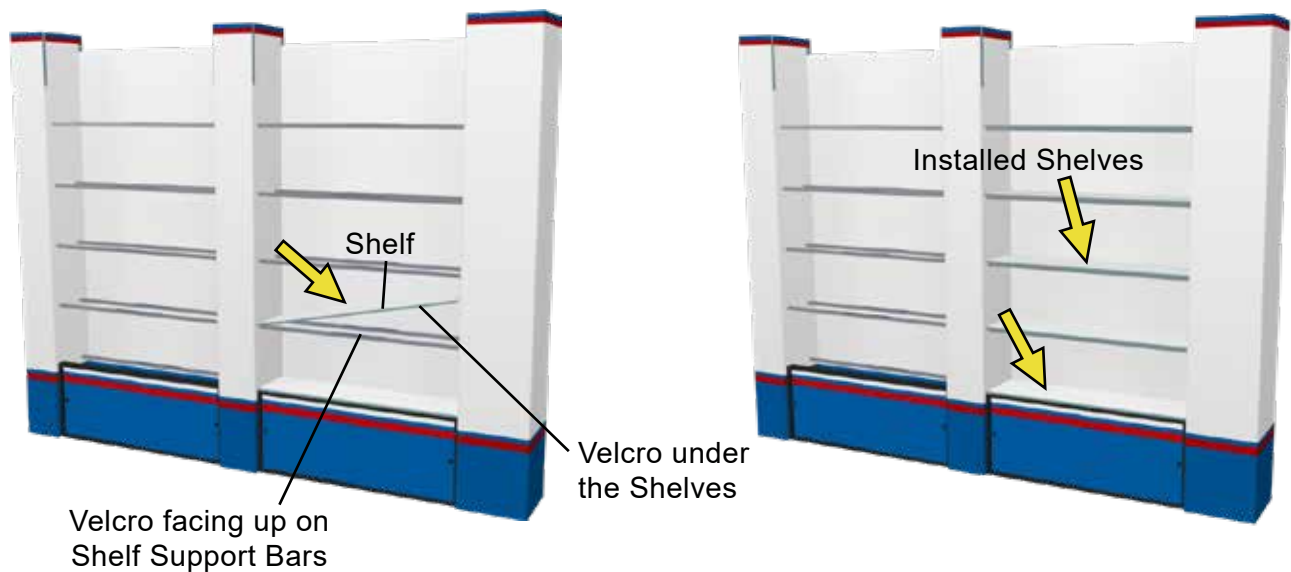

Light Support Bars and LED Light Detail:

A) Light Support Bars are color coded in this drawing to indicate Proper location. Additionally, the LED Lights are typically connected in series and powered within the Corner Pillars. (A sample configuration is shown below.)

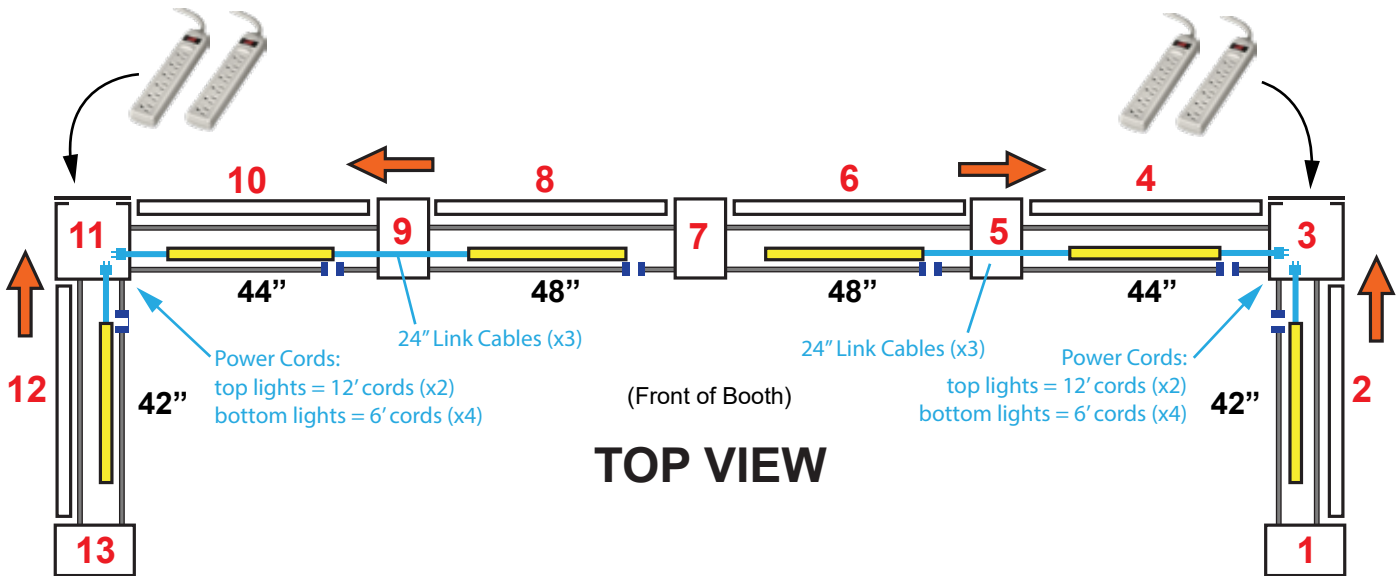

Light Cords are connected in series and run to the Corner Pillars in the directions shown by the arrows.

The Front Support Bars have Clips for the LED Lights.  
Support bars with ONLY Velcro on them are the rear shelf supports

Light Support Bars behind the Signs have no Velcro on them for easy identification.

View of installed Support Bars



LEGEND

<b>44"</b>	Length of Support Bar
	Support Bar (front)
	Support Bar (back)
	LED Light
	Power Cord
	Link Cable

LED Lamp Assembly Details

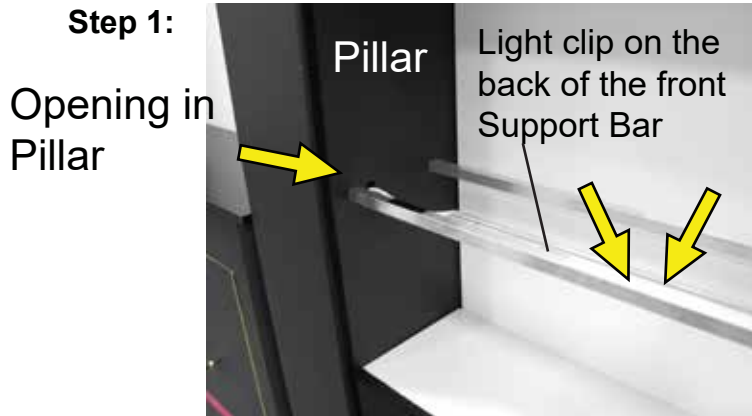

Start assembling the LED Lamps at the Pillars where the power will be connected. **(Orient the Shelf Support Bars so that the Velcro is facing up and the Clips are facing the backwall.)**



Attach the LED Lights to the back of the front Shelf Support Bars by pushing them into the clips.

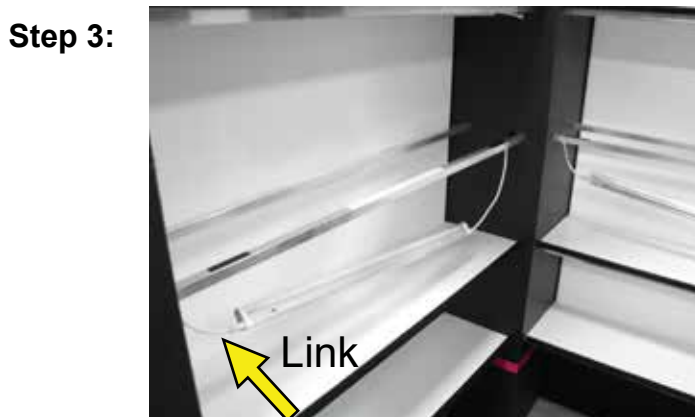

Attach LED Lights in series with Link Cables threaded through the openings in the Pillars.



## Assembly Instructions: InfiniLite 20-13

### LED Lamp Assembly Details

**Step 4:**



For the top shelf repeat the same process, but note the Light support bar is hidden behind the signs.

**Step 5:**

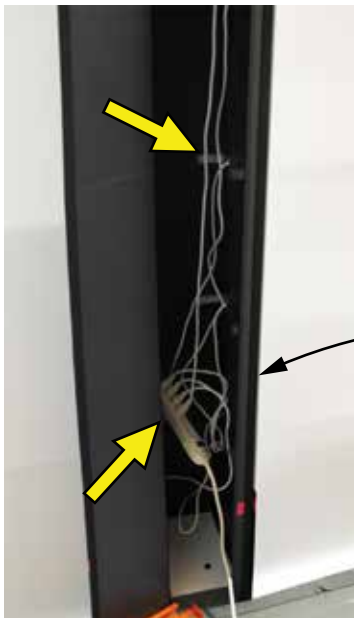

Connect the power for the LED Lights along the power strips located inside the Pillars as shown.

(Light cords connected in series and plugged into the power strip inside the Pillar.)

**Step 5:**



Close the column with the power supply access coming out the back.

## Assembly Instructions: InfiniLite 20-13

Attach the Grid wall to the inside of the Pillars.

A) Insert the Hanging Bars into the openings in the Pillars. Push the rubber stoppers against the Pillars to keep the bars securely in place.

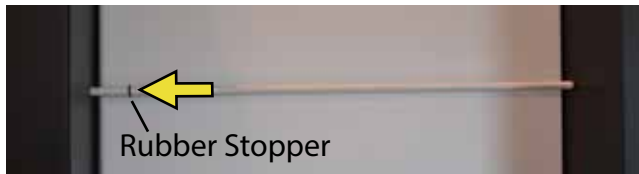

Hanging Bars installed

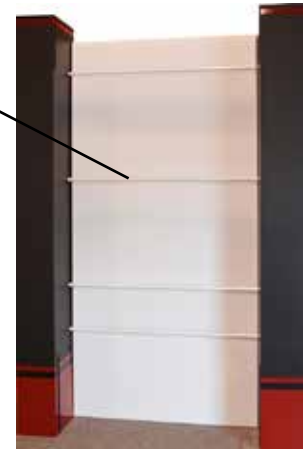

B) Use a hand clamp to temporarily hold the Grid wall Sections in place during assembly. Attach tie wraps to the Grid wall and Hanging Bars to secure the sections in place. Move the hand clamp to the next Grid wall Section and continue the Grid wall assembly as required.

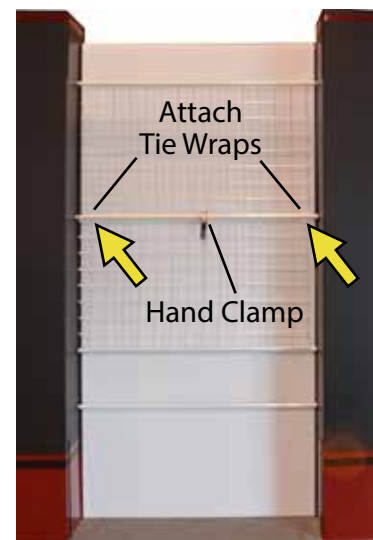

C) Use a hand clamp to temporarily hold the Grid wall Sections in place when the booth is dismantled. Cut the tie wraps to release the Grid wall Sections for packing and shipping.



View showing typical assembly of Grid wall Sections.





## Assembly Instructions: InfiniLite 20-13

Assemble Signs and attach to Pillars with Velcro.

A) Unfold the Signs.



B) Fold down the top sections of the Signs along the flutes to form a triangle and Velcro closed.

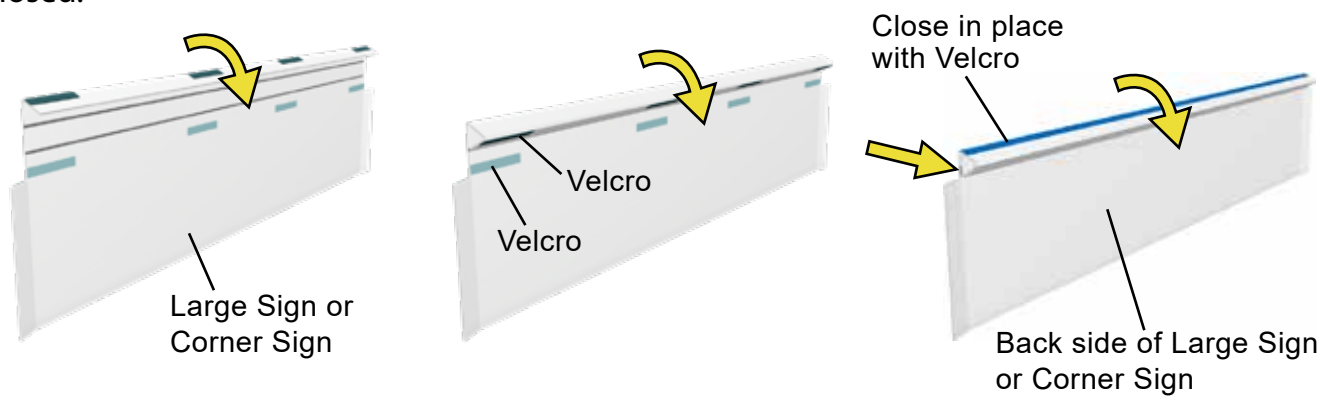

C) Attach Signs to Pillars with Velcro.

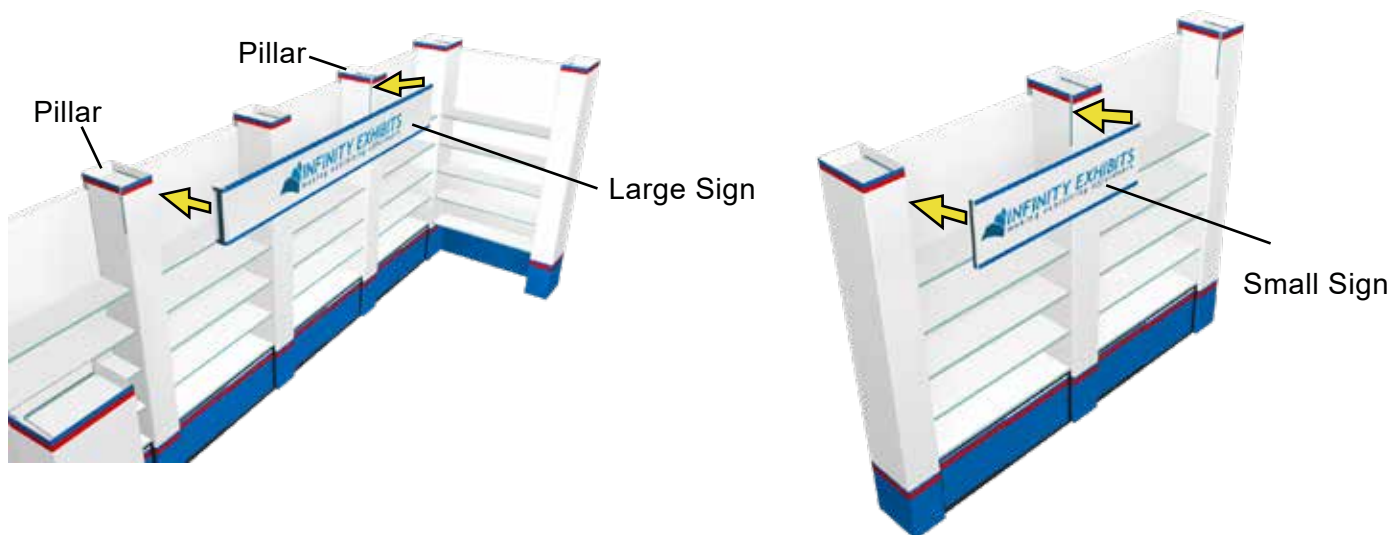



## Assembly Instructions: InfiniLite 20-13

Attach the Stem Lights to the tops of the Pillars.

A) Place a wooden Light Support Stick on top of the proper Pillars as shown. (Use a ladder or step stool to access the top of the Pillar.) Secure the Stick to the back of the Pillar with a Binder Clip.

B) Attach the Stem Light to the front end of the Pillar and Support Stick by adjusting the thumbscrew on the back of the Stem Light. (DO NOT overtighten the thumbscrew. Overtightening the adjustment thumbscrew may damage the Pillar.)

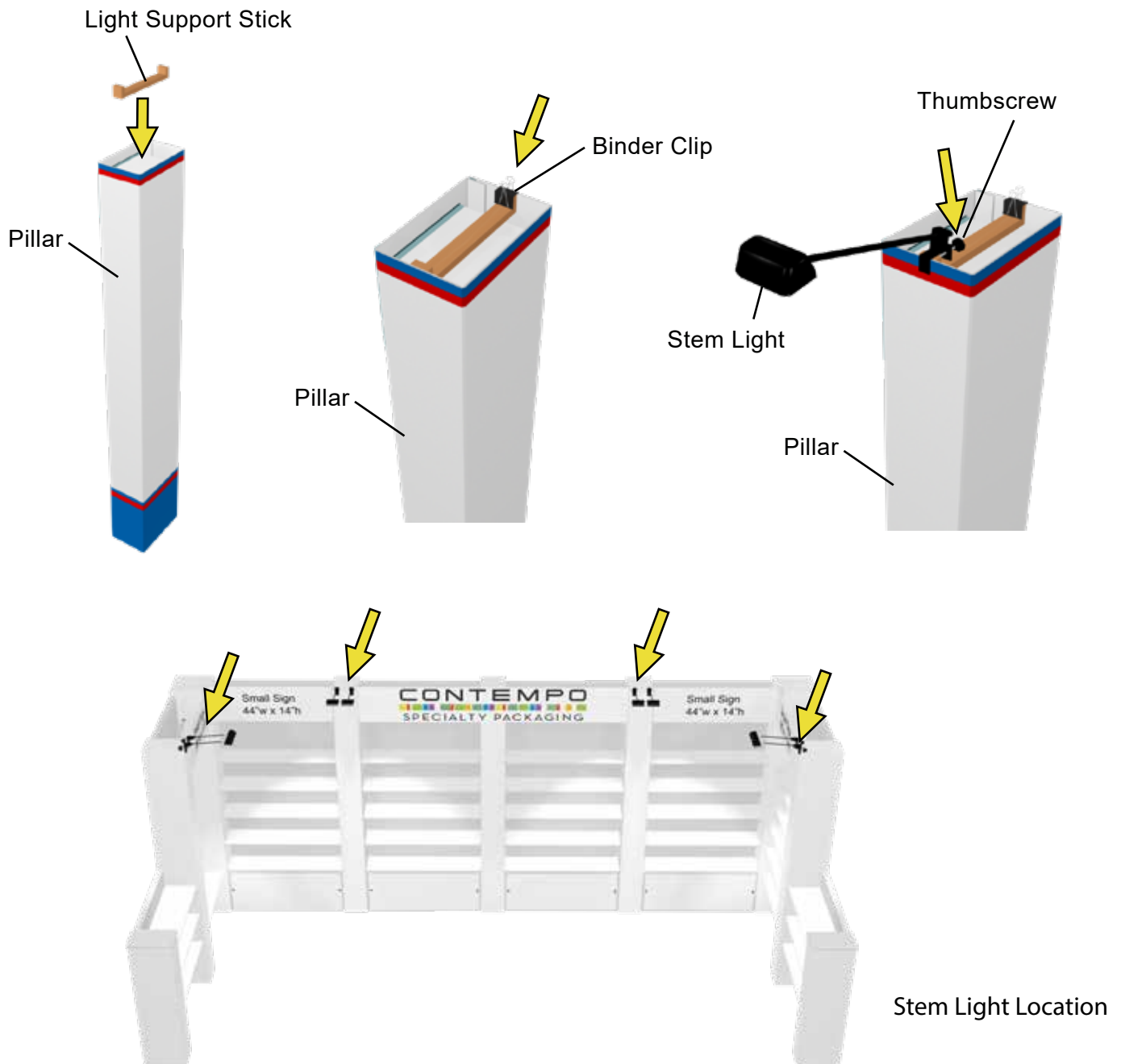

Counter Assembly:

A) Connect the Counter Panels together with the 90° Channels and Velcro. (Make sure that the Velcro is on top to attach the Counter Top.)

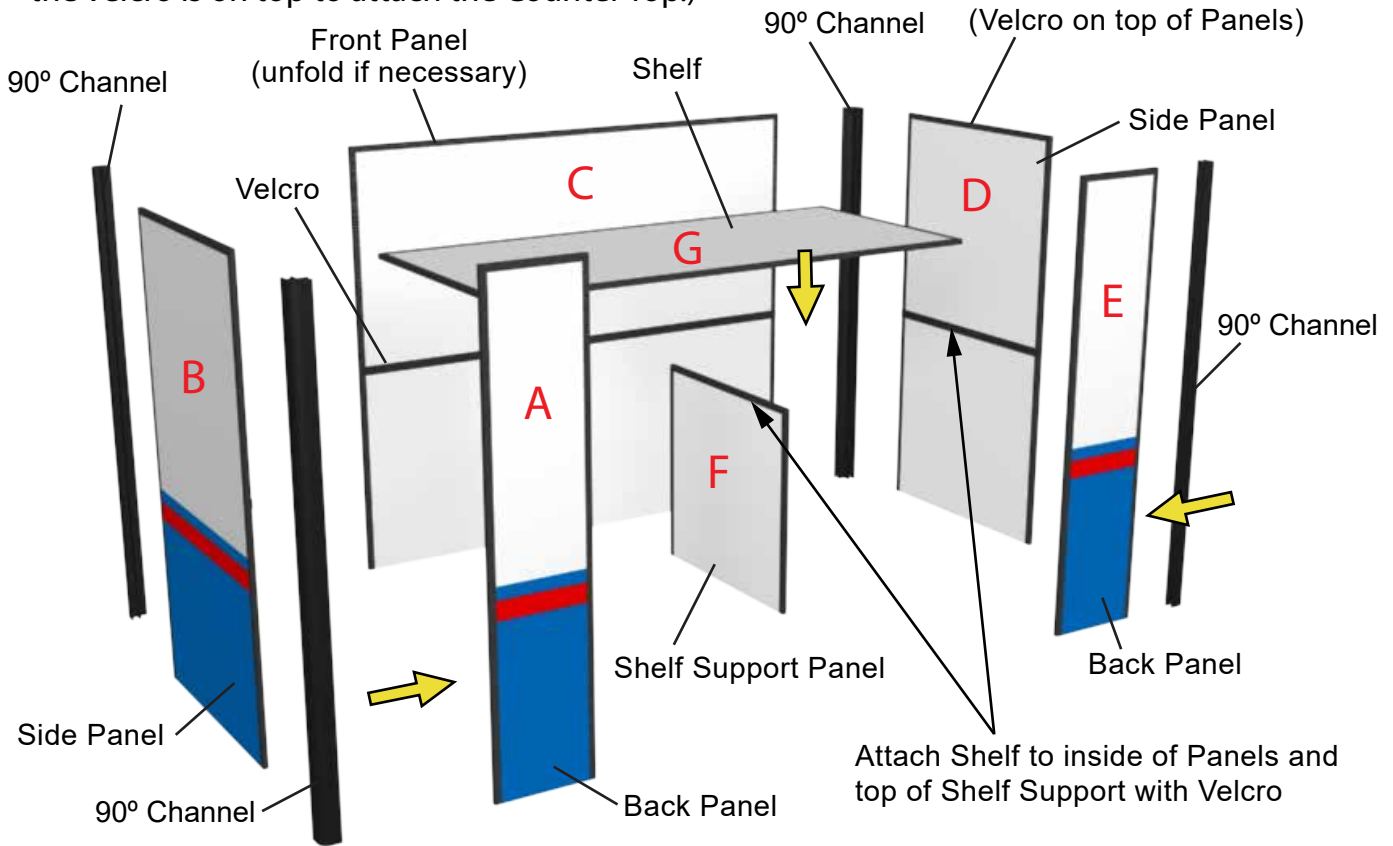

B) Place the Support Bar on top of the Back Panels and attach the Counter Top to the tops of the Panels and Support Bar with Velcro.

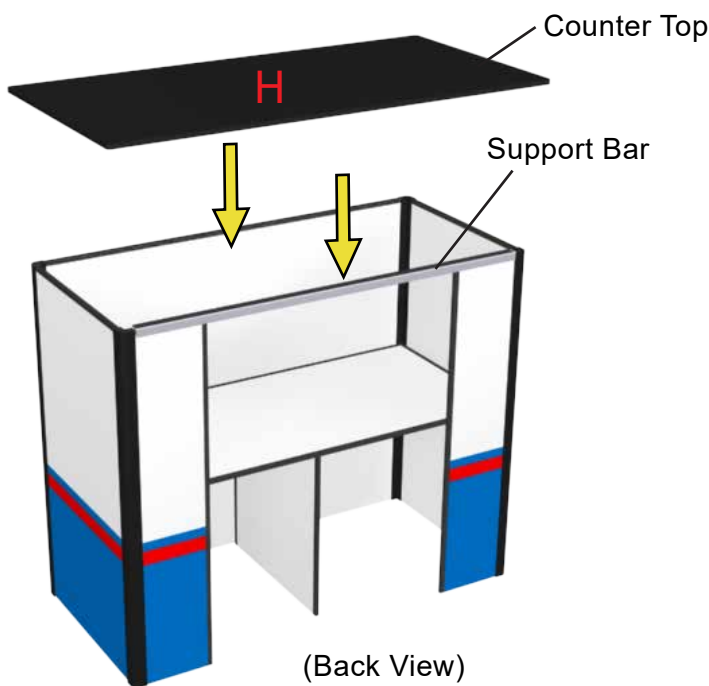

Attach Poster to front of the Counter with Velcro (if included as part of the Counter)



## Assembly Instructions: InfiniLite 20-13

### Case Layout

Divide the booth components for the 10'x20' Booth and pack the Tub in the following manner:

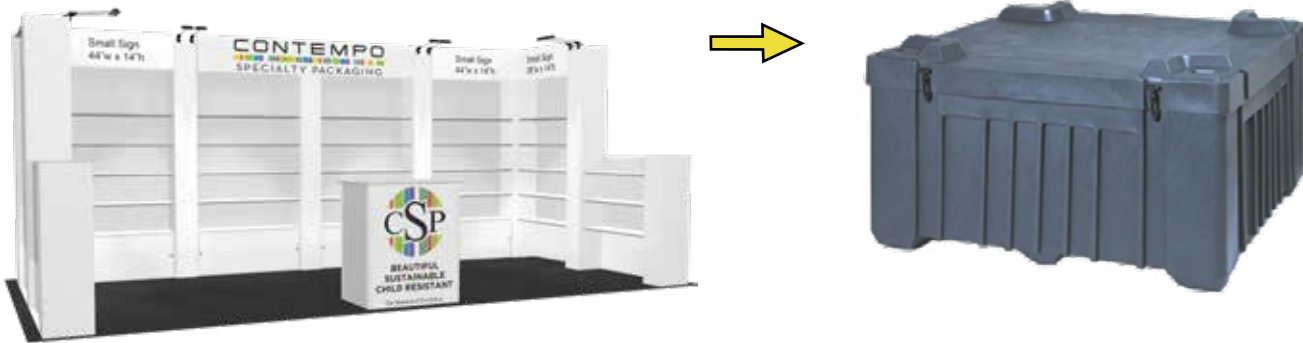

### Tub

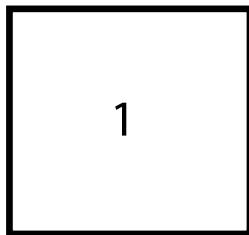

### Booth Components

- 1) Grid wall
- 2) Storage Frames
- 3) Support bars
- 4) Shelving
- 5) PVC Pillar tops
- 6) Power Supplies
- 7) Wall Panels
- 8) Pillars
- 9) Pillar Supports
- 10) Poster Box
- 11) Instruction Book
- 12) Light Sticks
- 13) Zip Ties
- 14) Signs
- 15) Lights

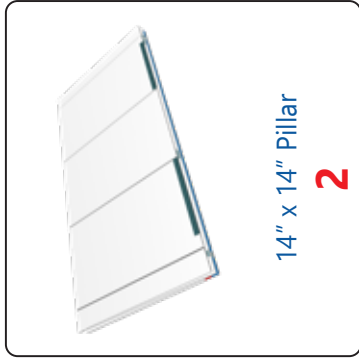

14" x 14" Pillar  
**2**

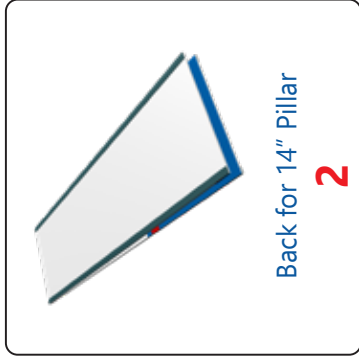

Back for 14" Pillar  
**2**

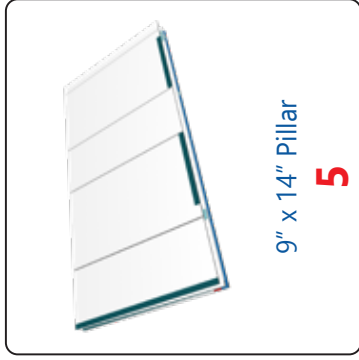

9" x 14" Pillar  
**5**

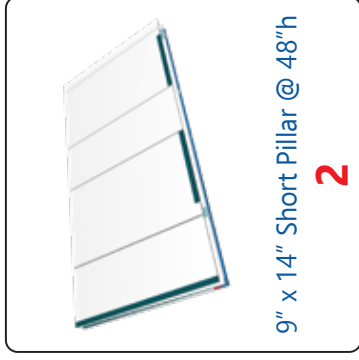

9" x 14" Short Pillar @ 48"h  
**2**

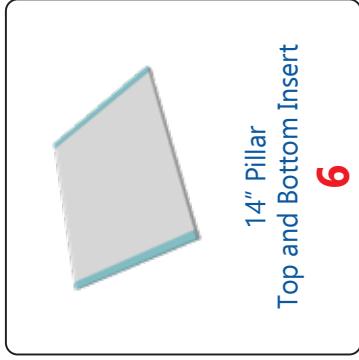

14" Pillar  
Top and Bottom Insert  
**6**

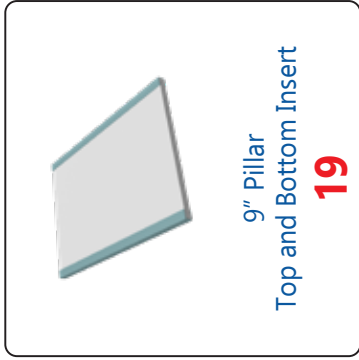

9" Pillar  
Top and Bottom Insert  
**19**

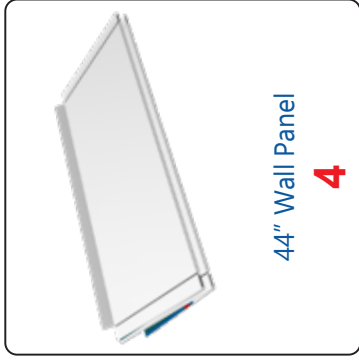

44" Wall Panel  
**4**

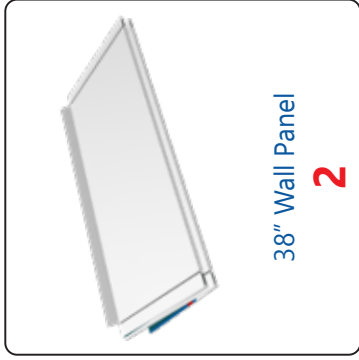

38" Wall Panel  
**2**

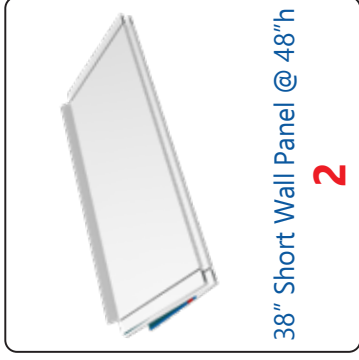

38" Short Wall Panel @ 48"h  
**2**



Large Sign  
**1**

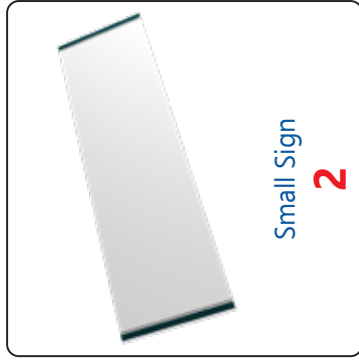

Small Sign  
**2**

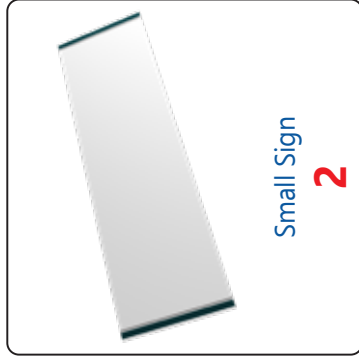

Small Sign  
**2**



44 $\frac{1}{4}$ " Shelf  
**20**

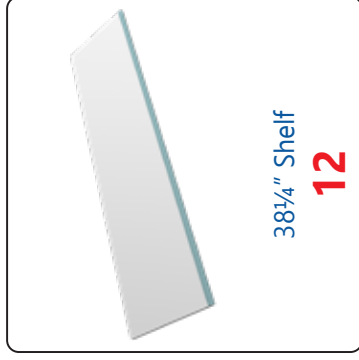

38 $\frac{1}{4}$ " Shelf  
**12**



48" Shelf/Light Support Stick  
**40**



44" Shelf/Light Support Stick  
**26**

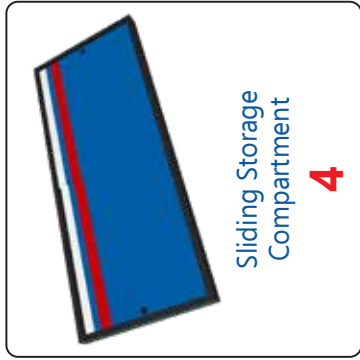

Sliding Storage  
Compartment  
**4**

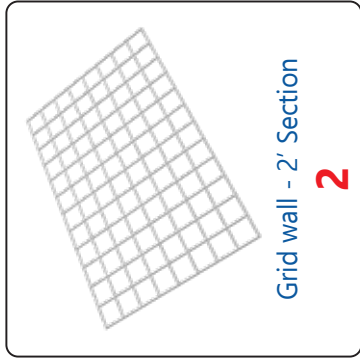

Grid wall - 2' Section  
**2**



Grid wall Hanging Bar  
**3**

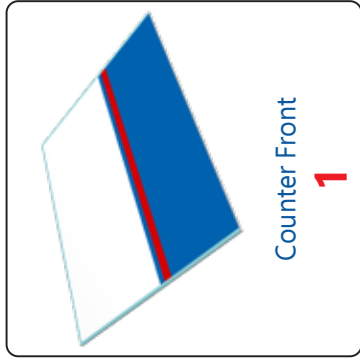

Counter Front  
**1**

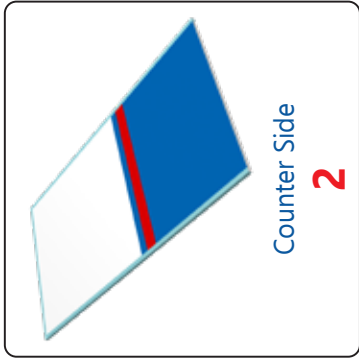

Counter Side  
**2**

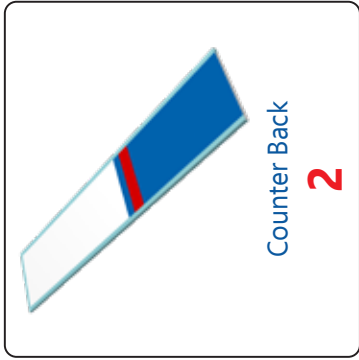

Counter Back  
**2**

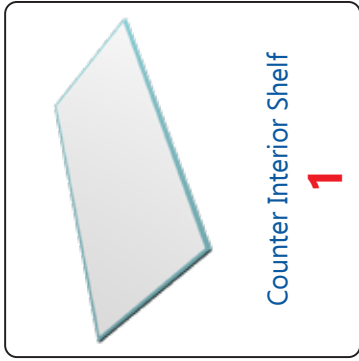

Counter Interior Shelf  
**1**

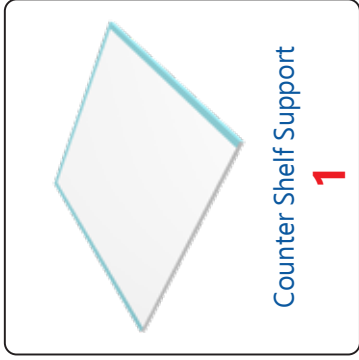

Counter Shelf Support  
**1**

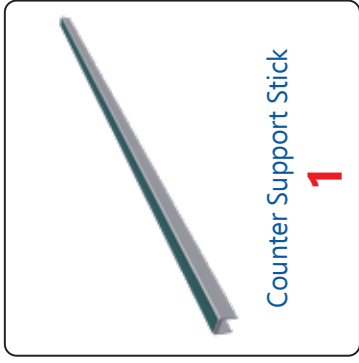

Counter Support Stick  
**1**

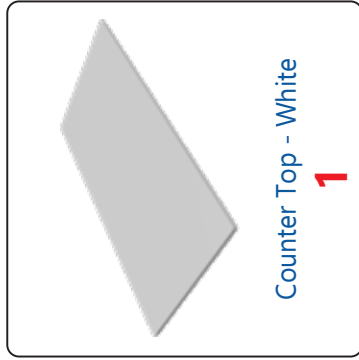

Counter Top - White  
**1**

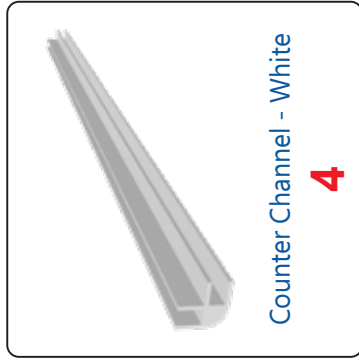

Counter Channel - White  
**4**



White Stem Light - SL526D  
**8**



Light Support & Clip  
**8**



Power/Extension Cord  
**2**



LED Light Bar  
**30**



LED Power Cord - 12'  
**4**



LED Power Cord - 6'  
**14**



LED Link Cable - 24'  
**12**

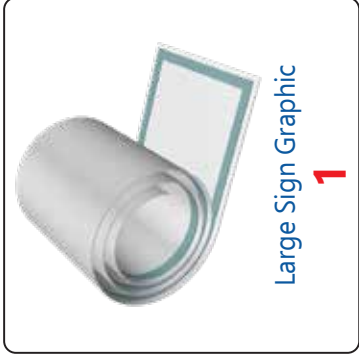

Large Sign Graphic  
**1**



Counter Graphic  
**1**