

# Active Brands

## Display Setup Instructions



20' x 20' Display Booth





14" x 14" Pillar  
**2**

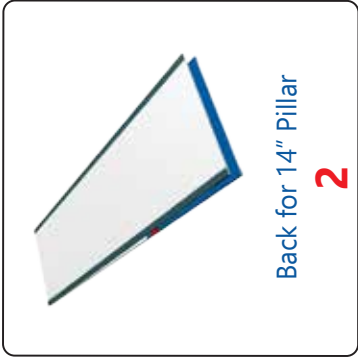

Back for 14" Pillar  
**2**

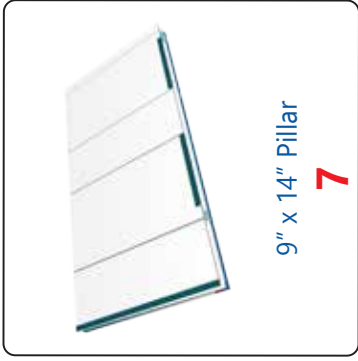

9" x 14" Pillar  
**7**

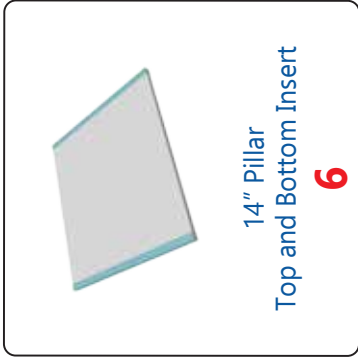

14" Pillar  
Top and Bottom Insert  
**6**

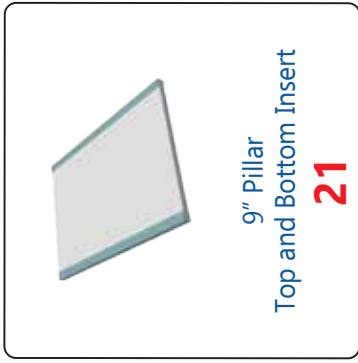

9" Pillar  
Top and Bottom Insert  
**21**



44" Wall Panel  
**2**



44" Tall Wall Panel (96")  
**2**

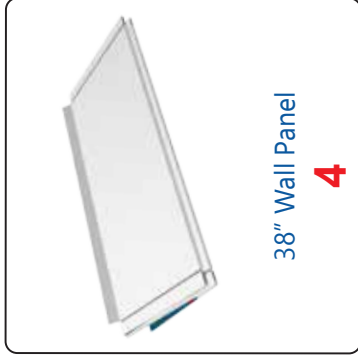

38" Wall Panel  
**4**



Backwall Support  
**2**

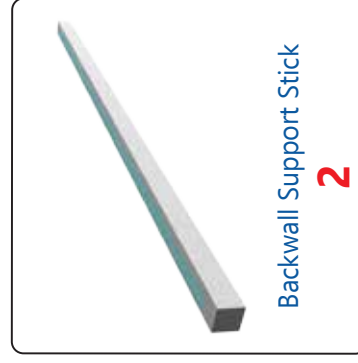

Backwall Support Stick  
**2**



Corner Sign  
**2**



Small Sign  
**2**



44<sup>1</sup>/<sub>4</sub>" Shelf  
**2**

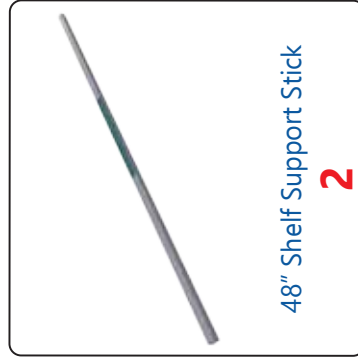

48" Shelf Support Stick  
**2**

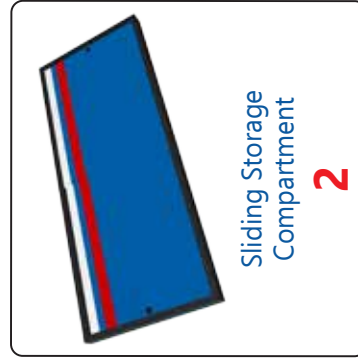

Sliding Storage  
Compartment  
**2**

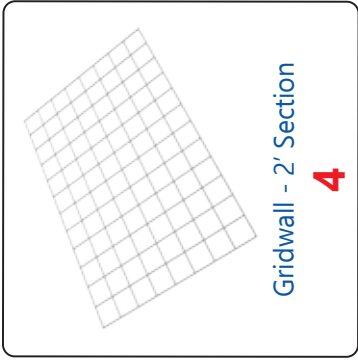

Gridwall - 2' Section  
**4**



Gridwall Hanging Bar  
**6**

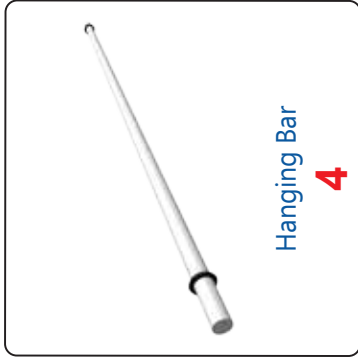

Hanging Bar  
**4**

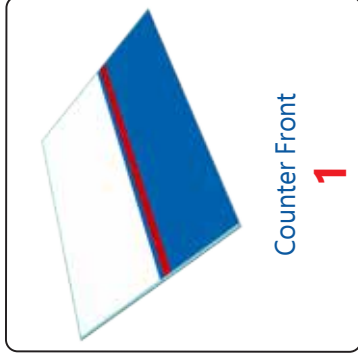

Counter Front  
**1**

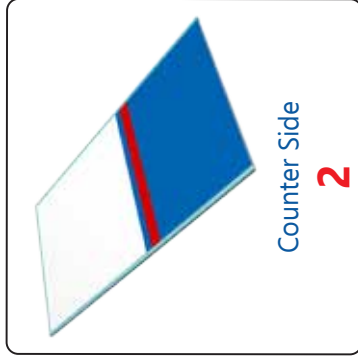

Counter Side  
**2**

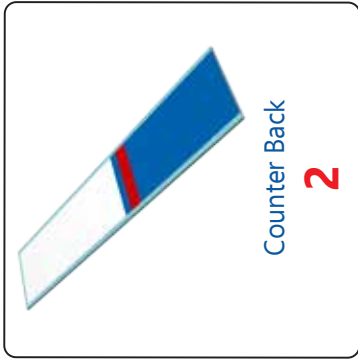

Counter Back  
**2**

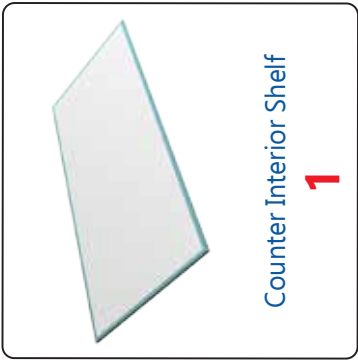

Counter Interior Shelf  
**1**

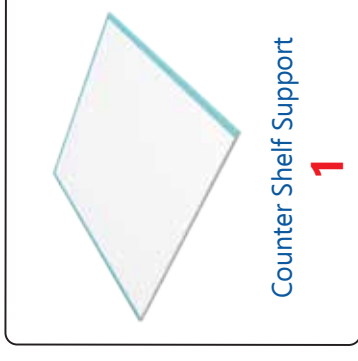

Counter Shelf Support  
**1**

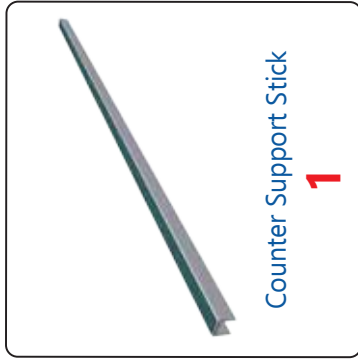

Counter Support Stick  
**1**

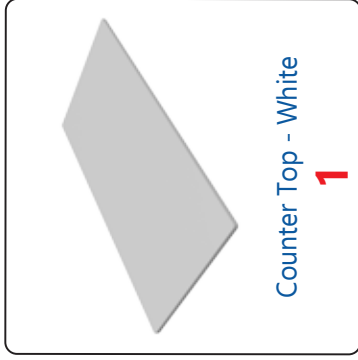

Counter Top - White  
**1**



Corner Sign Graphic  
**2**



Small Sign Graphic  
**2**



Wall Panel Graphic  
**2**

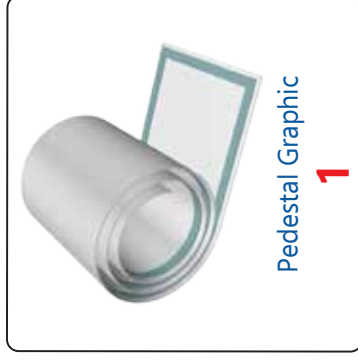

Pedestal Graphic  
**1**



Fabric Graphic  
**1**



White Stem Light - SL518  
**8**



Wooden Light Stick  
**8**



Light Stick Clip  
**8**



Extra Halogen Light Bulb  
**1**



Extension Cord  
**2**



Power Strip  
**2**

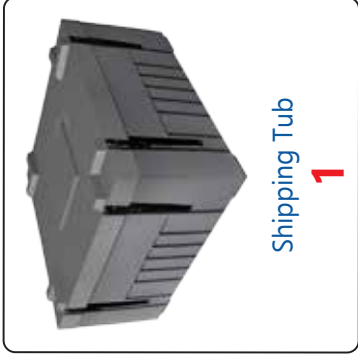

Shipping Tub  
**1**



### Steps to Assemble the InfiniLite Multi Section Exhibit Booth:

- Step 1:** Assemble the Pillars and Corner Pillars.
- Step 2:** Place Pillars upright in their proper order and orientation.
- Step 3:** Attach Wall Panels to Pillars.
- Step 4:** Install Shelf Support Bars into sides of Pillars.
- Step 5:** Install Storage Doors.
- Step 6:** Attach Shelves to Shelf Support Bars with Velcro.
- Step 7:** Attach Signs to inside of Pillars with Velcro.
- Step 8:** Install the Gridwall Sections between the Pillars.
- Step 9:** Attach the Graphics to the backwall with Velcro.
- Step 10:** Attach Stem Lights to tops of Pillars.
- Step 11:** Assemble the front displays and place them within the booth area.
- Step 12:** Assemble pedistal and place within booth space.

Enter the link below for an instructional video:

<http://youtu.be/-INxoiV-fG4>

**Assemble the Pillars.**

A) Unfold the Pillar Panels with the front sides facing downward.

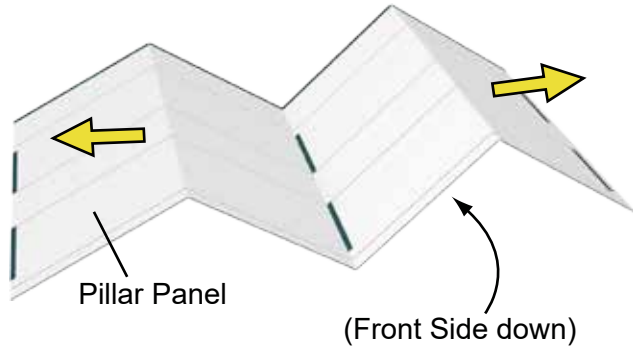

B) Attach the Top, Middle and Bottom Supports to the back of the Pillars with Velcro.

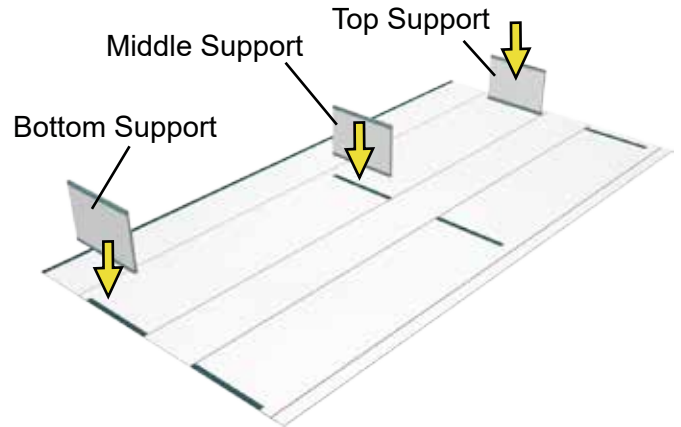

C) Fold Pillar around the Supports and attach with Velcro.

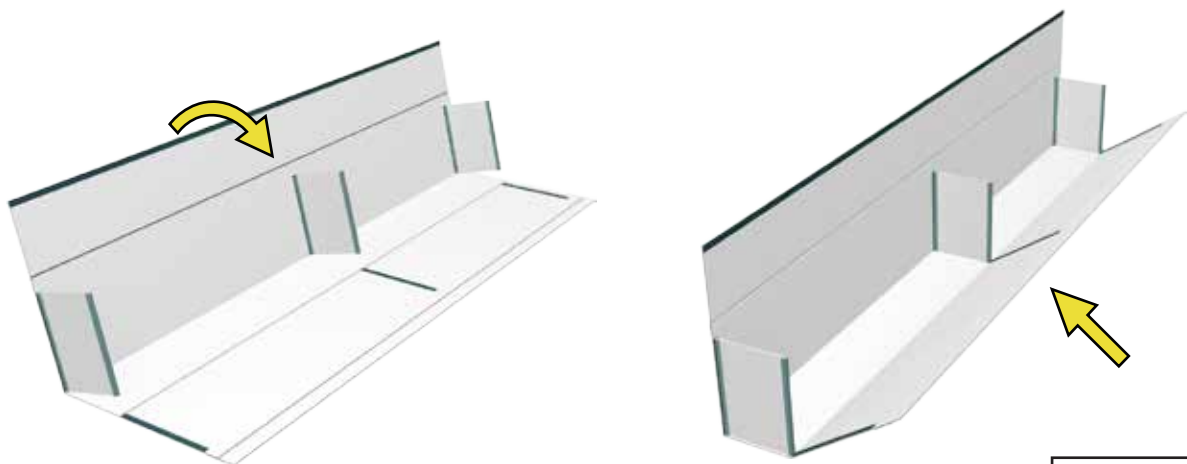

D) Close the Pillar using the Velcro strips along the Pillar edges.

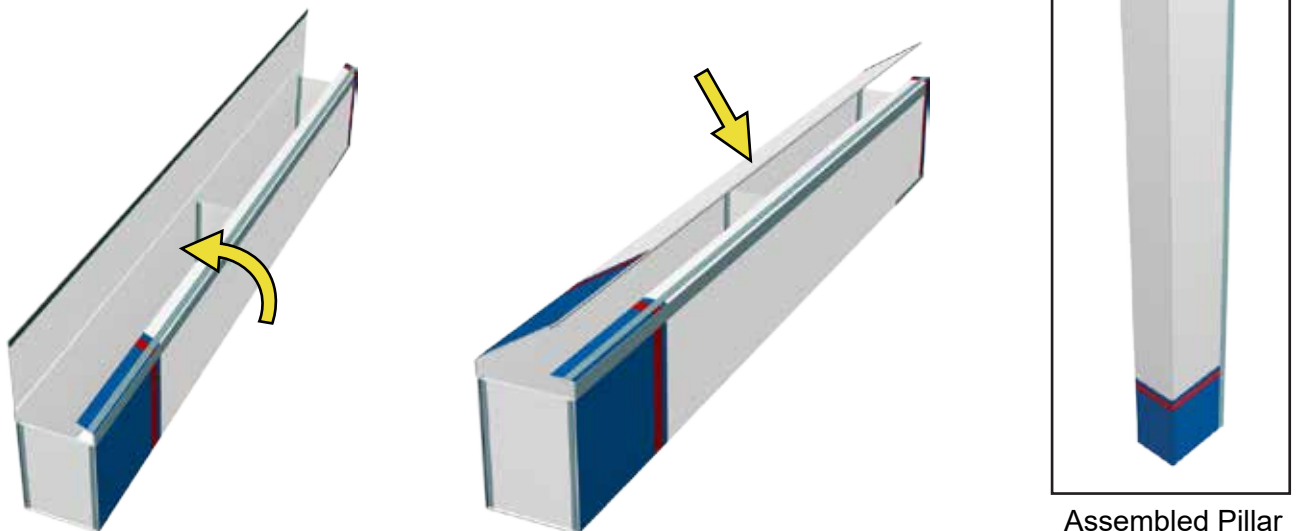

**Assemble Corner Pillars.**

E) Unfold the Corner Pillar Panels with the front sides facing downward.

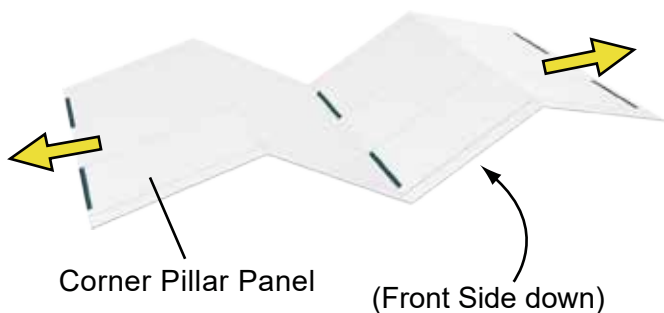

F) Attach the Top, Middle and Bottom Supports to the back of the Corner Pillars with Velcro.

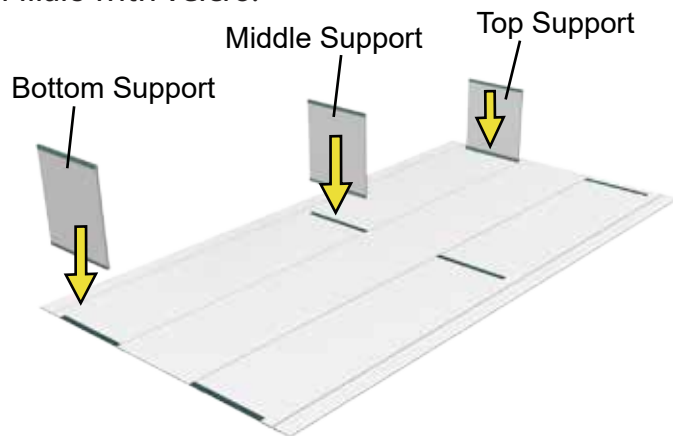

G) Fold the Corner Pillar around the Supports and attach with Velcro.

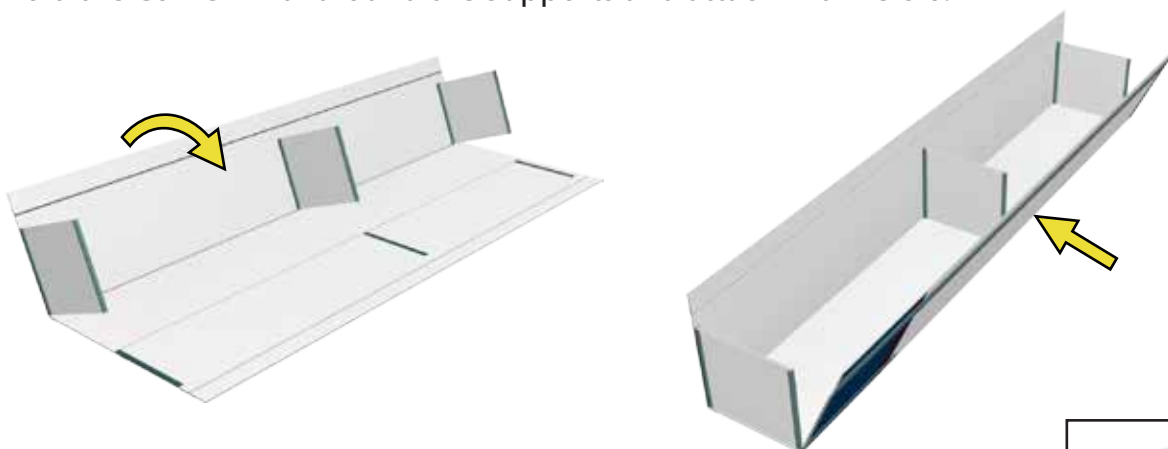

H) Attach the Back Cover to the bottom half of the Corner Pillar with Velcro; unfold the Back Cover; then attach the remaining Back Cover to the upper half of the Corner Pillar.

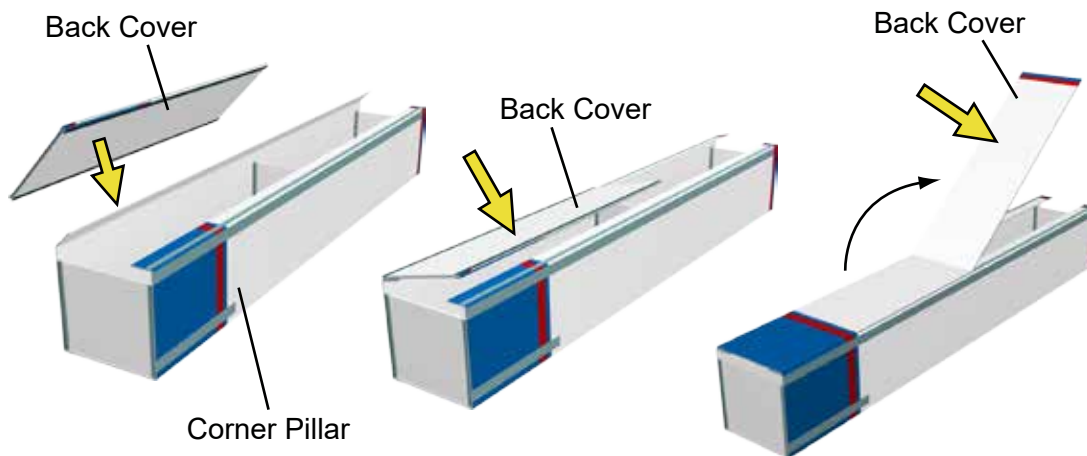

# Assembly Instructions: InfiniLite 20-12



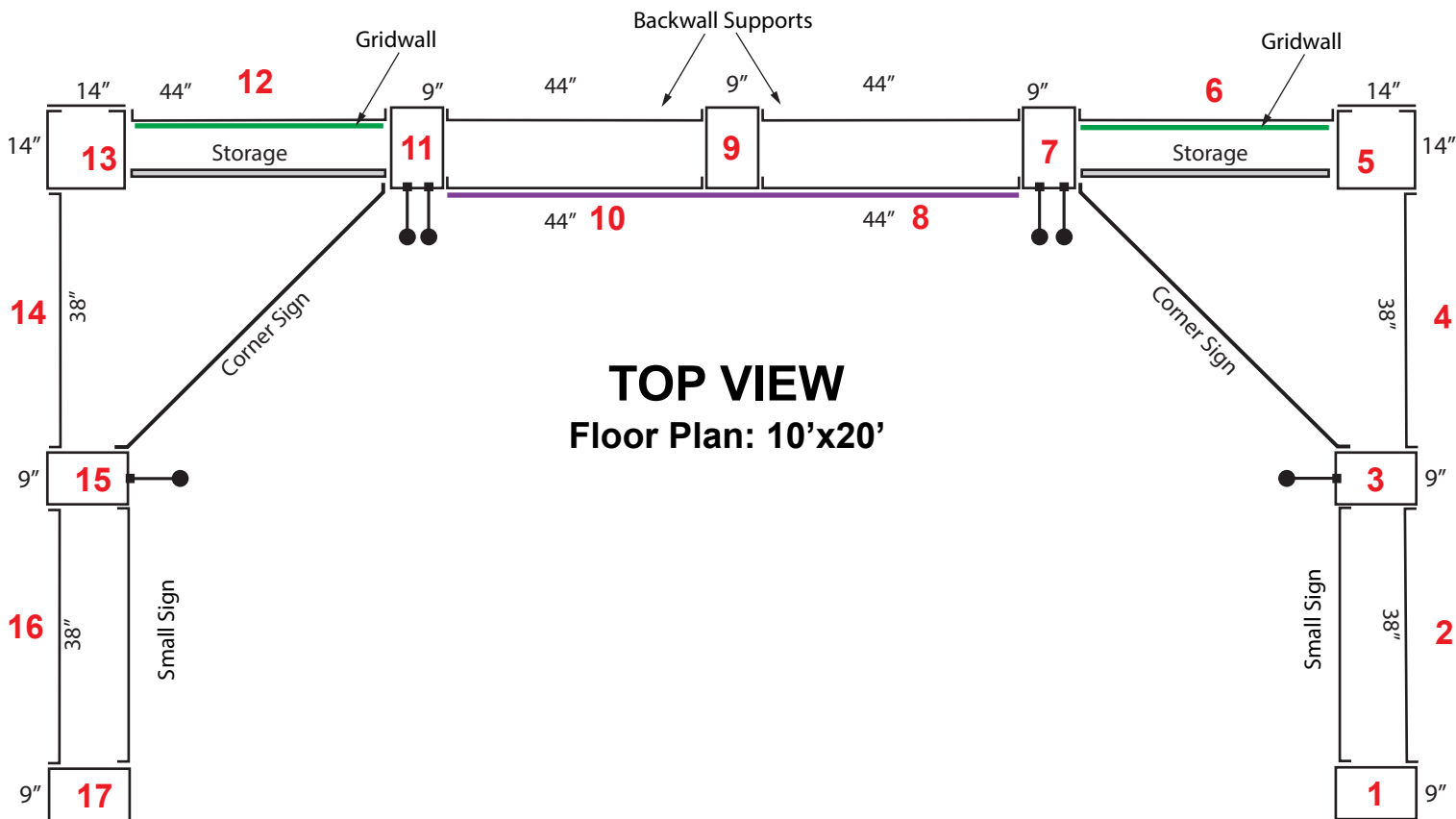

The following Floor Plan identifies the locations of the Booth Components:



(Front of Booth)



## LEGEND

	Storage Doors
	Gridwall
	Fabric Graphic
	Stem Light

**Assembly Instructions:**

**InfiniLite 20-12**

Place the assembled Pillars and Corner Pillars upright in their proper order and assigned locations as numbered and indicated on the Floor Plan.

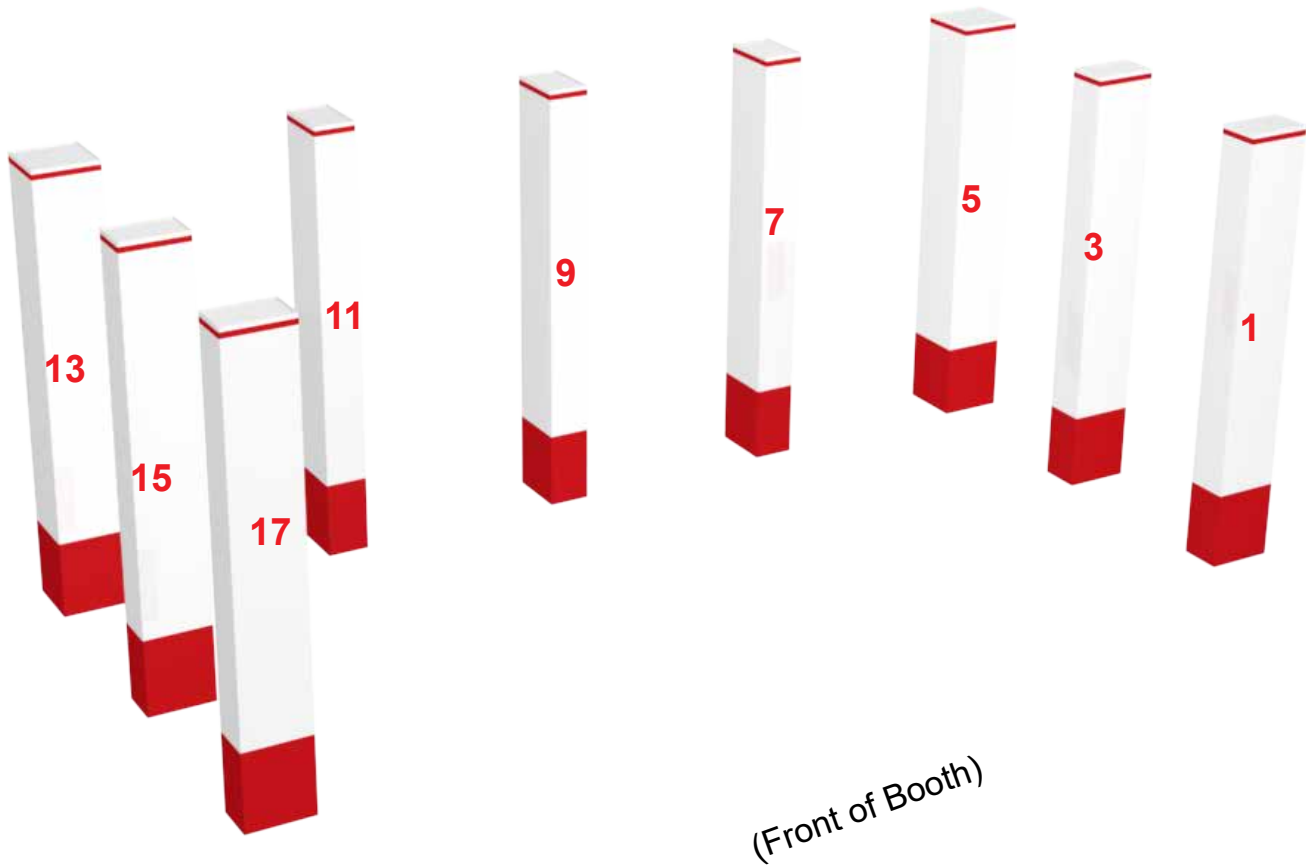

**Floor Plan: 10'x20'**

**Basic method of attaching Wall Panels to Pillars.**

A) Unfold the bottom half of the Wall Panel, hold upright and attach to the side of the Pillar with Velcro. (Make sure that the Pillar and Wall Panel are **flat** on the floor surface when attaching and that the accent stripes are aligned with each other.) Begin assembly from either the left or right side of the Booth.

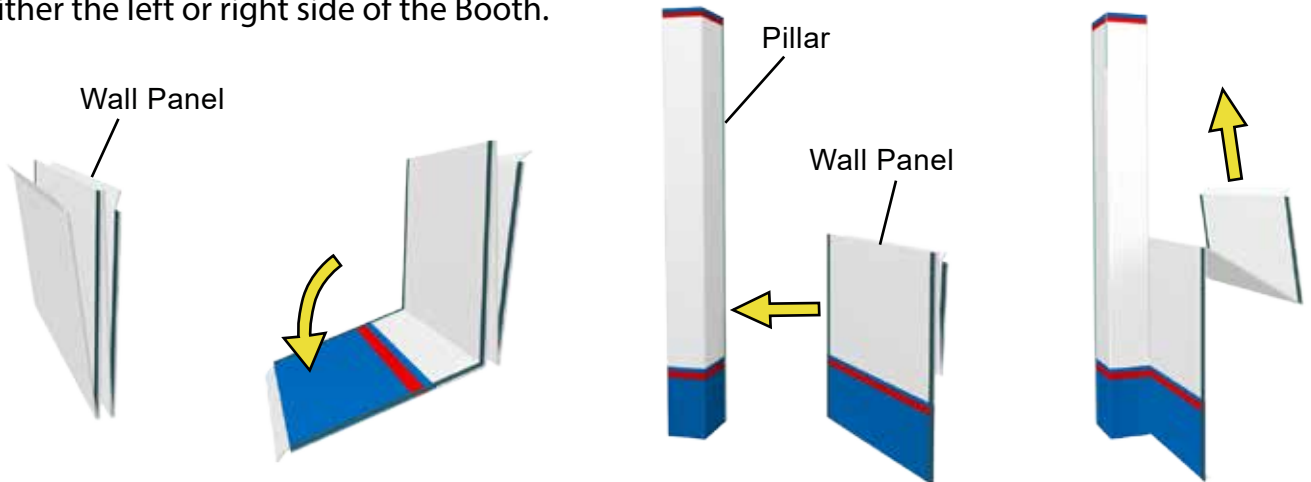

B) Unfold the top half of the Wall Panel and attach it to the top half of the Pillar matching the Velcro strips along the edges. Rotate the Wall Panel into position. Attach the next Pillar to the Wall Panel so that it is flat against the front face of the Wall Panel. Rotate the Pillar into position.

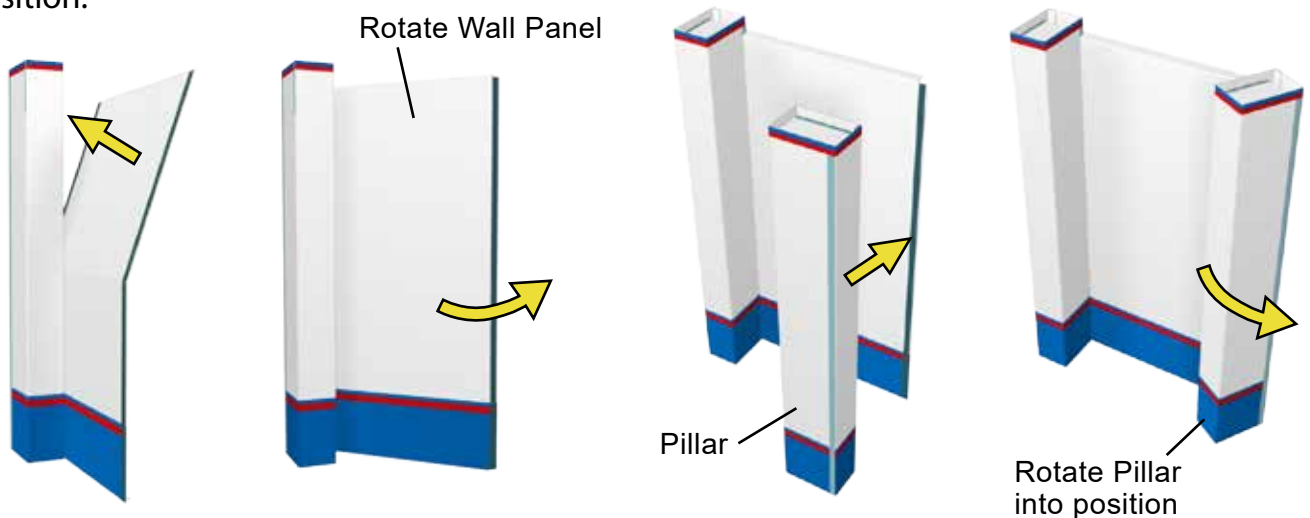

C) Repeat this process with the remaining Wall Panels and Pillars.



**Attach Wall Panel Supports.**

A) Wall Panels that support large posters are reinforced in the back with Support Sticks at the top and backwall supports at the bottom. Attach these supports to the Wall Panels with Velcro.

Attach the Support Sticks to the top of the backwall Wall Panels with Velcro.

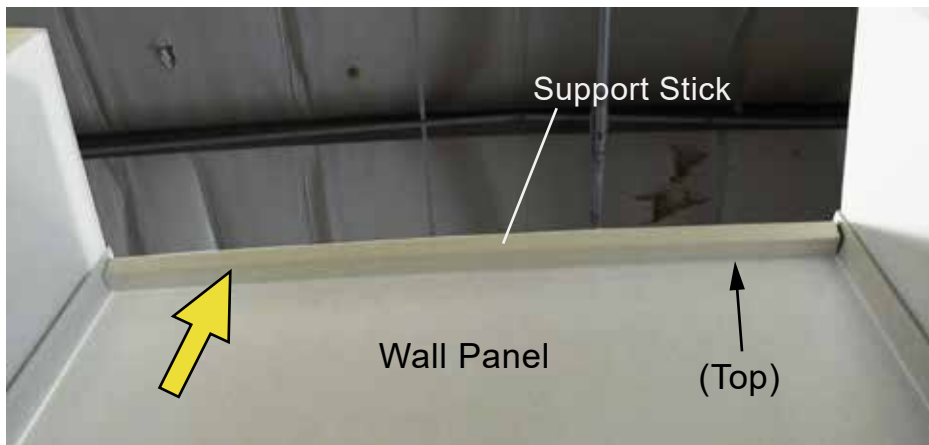

Support Stick attached to top of Wall Panel.

Attach the Backwall Supports to back of Pillars at the bottom with Velcro.

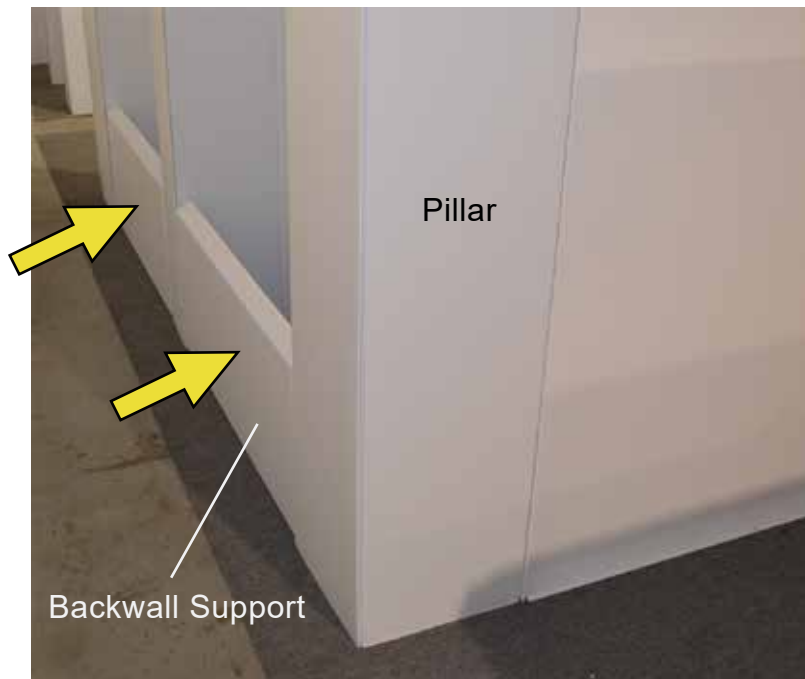

Backwall Supports aid to stabilize the booth.

## Assembly Instructions: InfiniLite 20-12

### Install the Shelf Support Bars.

A) Insert the shelf support bars into the designated openings in the Pillars.

Make sure that the **Velcro on the bars is facing upward** to attach the shelves.

**NOTE:** Images on this page show typical installation of Shelf Support Bars, Storage Doors and Shelves.

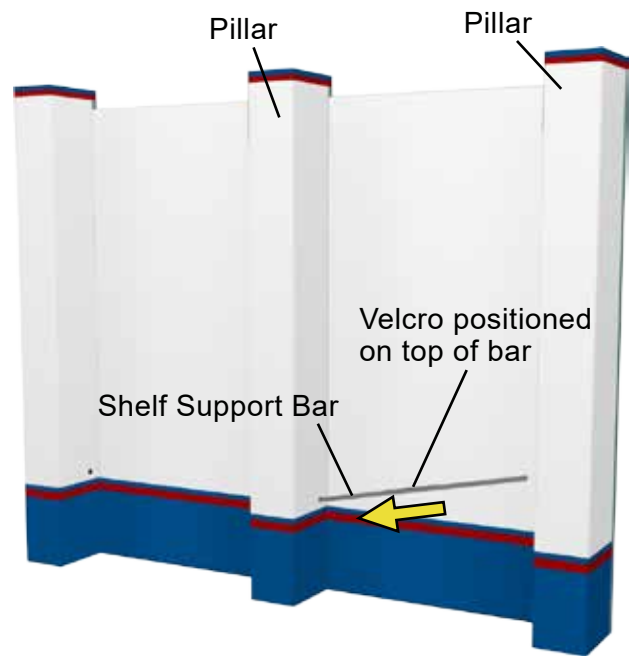

### Install the Storage Doors. (Attach Storage Doors to the inside of the Pillars with Velcro.)



### Attach Shelves to the Shelf Support Bars and top of Storage Doors with Velcro.

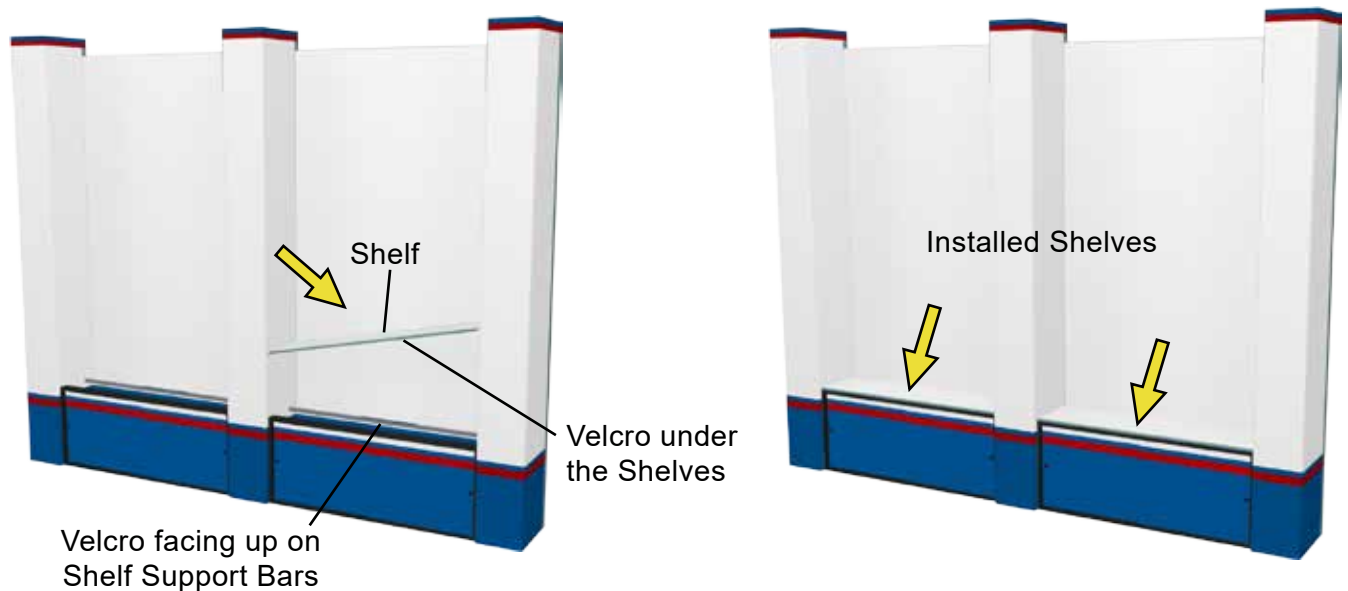

**Attach the Large Poster to the middle Wall Panels and Center Pillar with Velcro.**

A) Unroll the Fabric Graphic and attach it to the Backwall with Velcro.

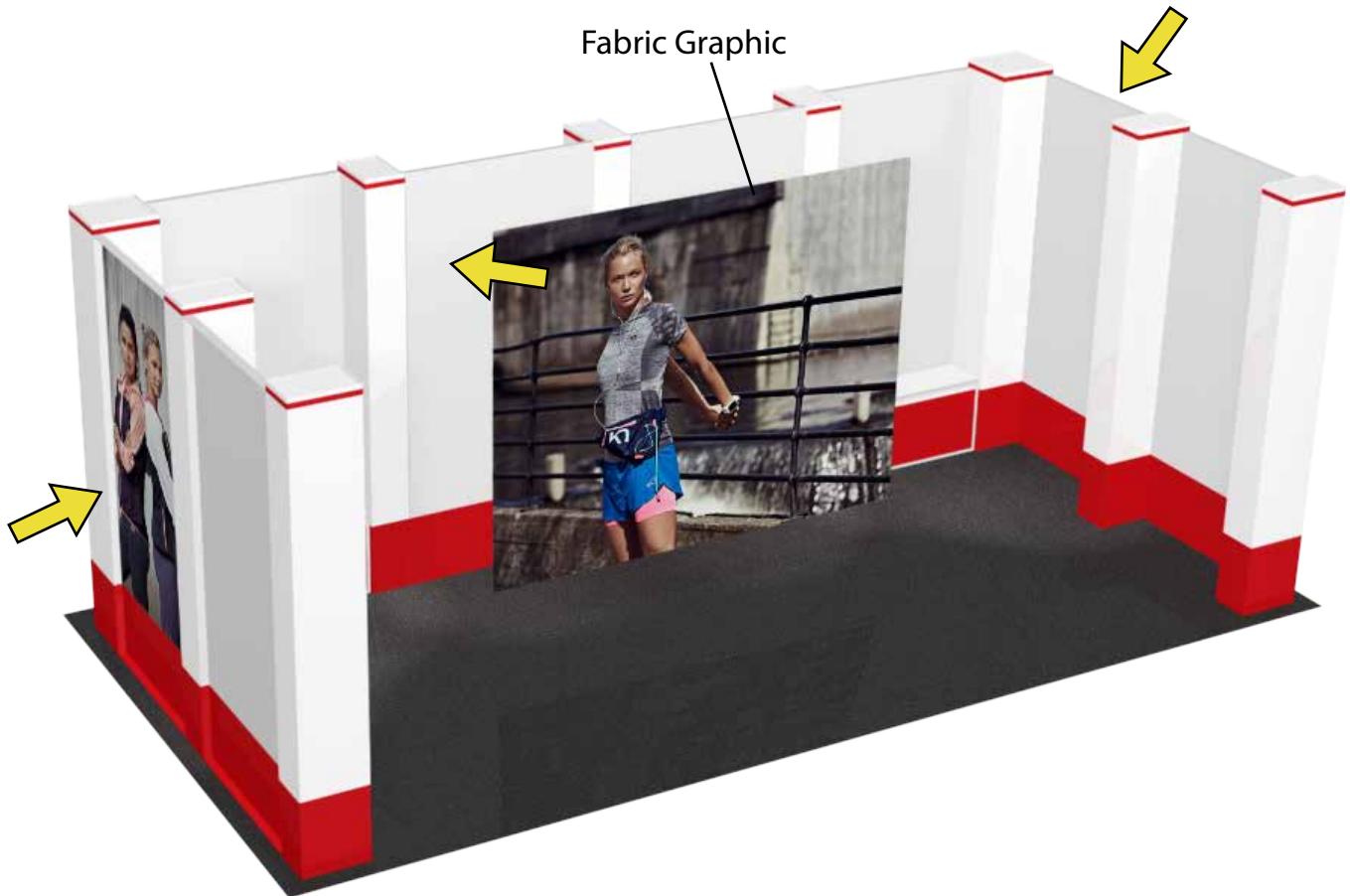

B) Unroll the Posters and attach it to the Side-wall with Velcro.

Assemble Signs and attach to Pillars with Velcro.

A) Unfold the Corner Signs.



B) Fold down the top sections of the Sign along the flutes to form a triangle and Velcro closed.

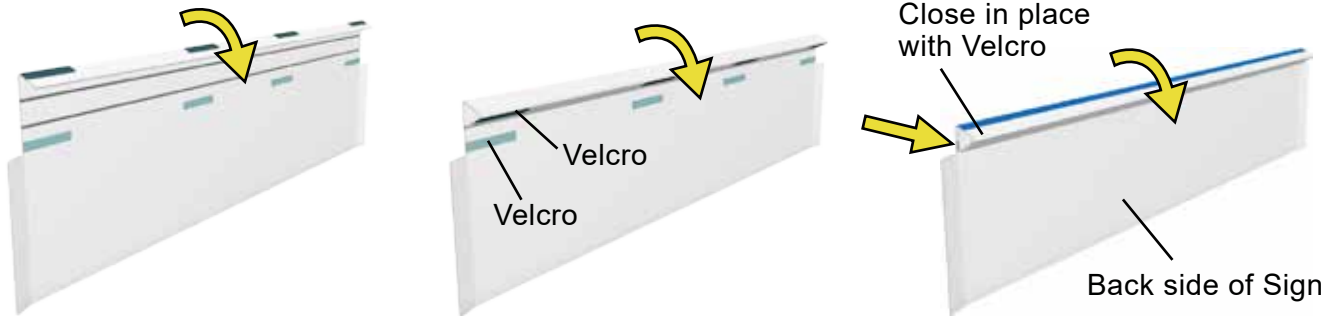

C) Attach Signs to Pillars with Velcro. Attach the Header Posters to the Signs with Velcro.



## Assembly Instructions: InfiniLite 20-12

### Attach the Gridwall to the inside of the Pillars.

A) Insert the Hanging Bars into the openings in the Pillars. Push the rubber stoppers against the Pillars to keep the bars securely in place.

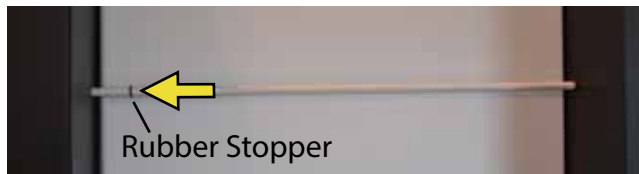
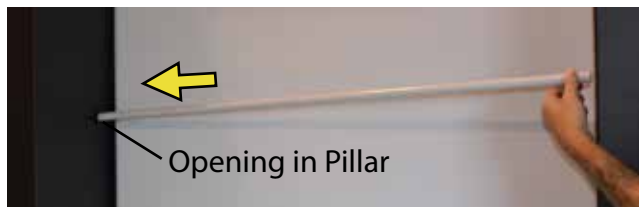

Hanging Bars installed



B) Use a hand clamp to temporarily hold the Gridwall Sections in place during assembly. Attach tie wraps to the Gridwall and Hanging Bars to secure the sections in place. Move the hand clamp to the next Gridwall Section and continue the Gridwall assembly as required.

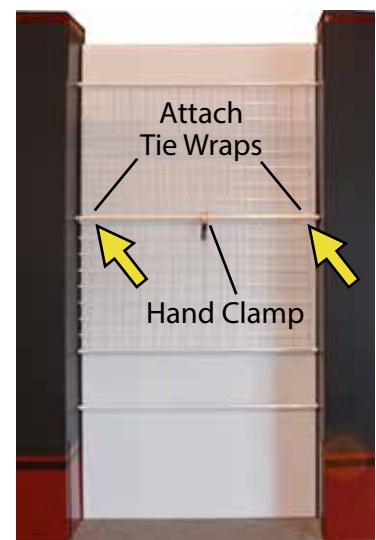

C) Use a hand clamp to temporarily hold the Gridwall Sections in place when the booth is dismantled. Cut the tie wraps to release the Gridwall Sections for packing and shipping.



View showing typical assembly of Gridwall Sections.



**Attach the Stem Lights to the tops of the Pillars.**

A) Place a wooden Light Support Stick on top of the proper Pillars as shown. (Use a ladder or step stool to access the top of the Pillar.) Secure the Stick to the back of the Pillar with a Binder Clip.

B) Attach the Stem Light to the front end of the Pillar and Support Stick by adjusting the thumbscrew on the back of the Stem Light. (**DO NOT** overtighten the thumbscrew. Overtightening the adjustment thumbscrew may damage the Pillar.)

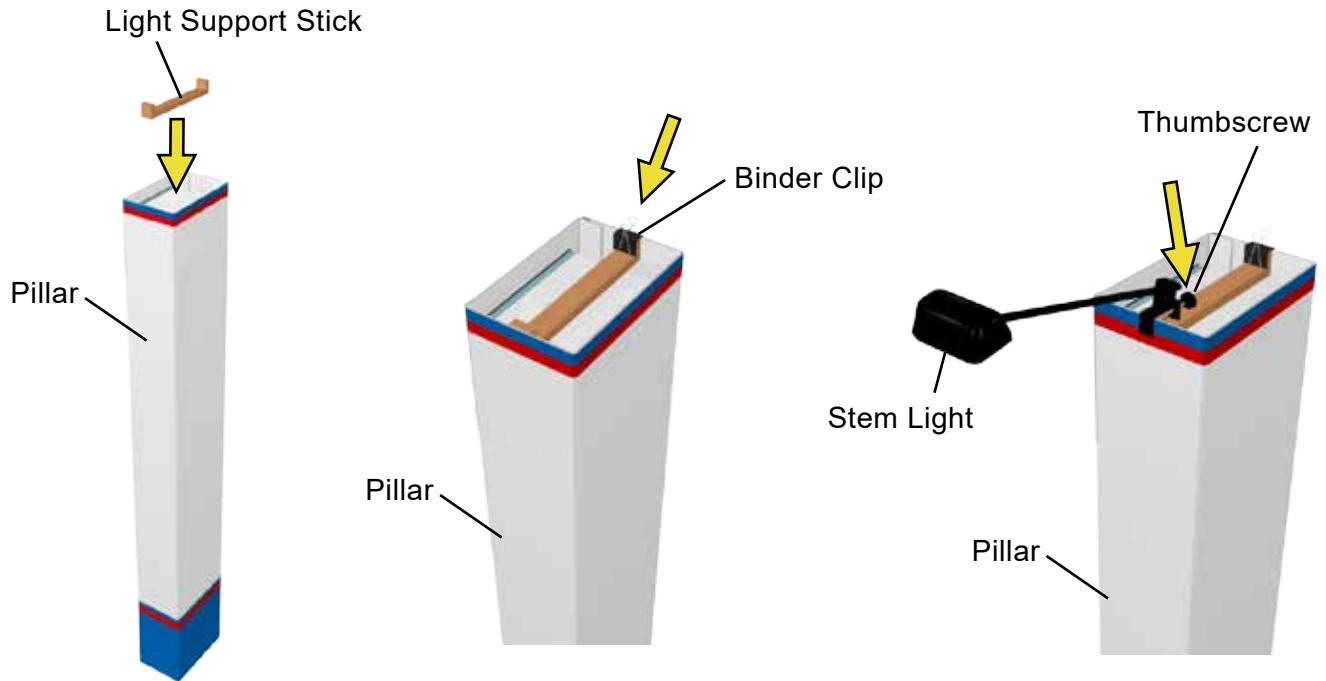

**Counter Assembly:**

A) Connect the Counter Panels together with the 90° Channels and Velcro. (Make sure that the Velcro is on top to attach the Counter Top.)

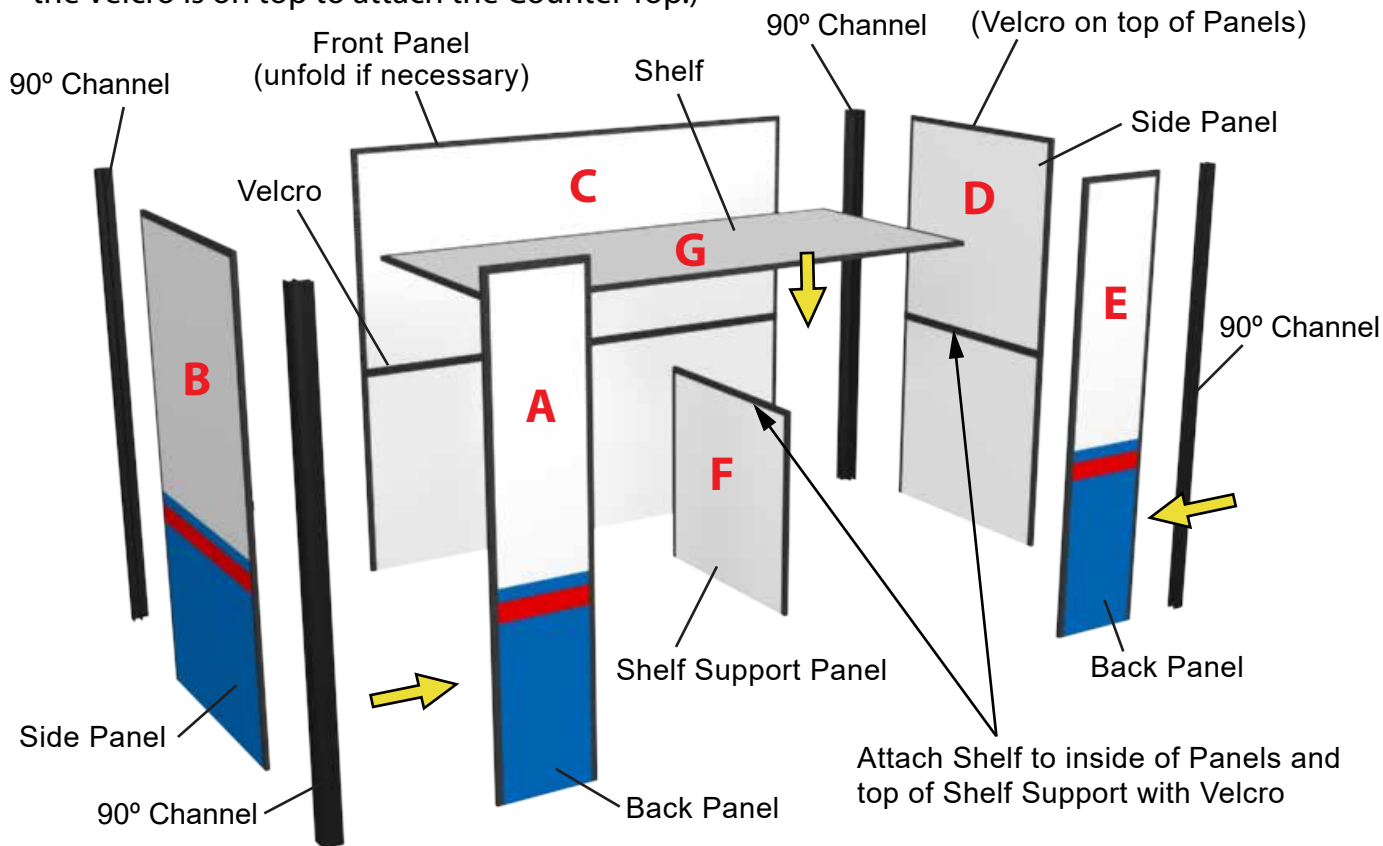

B) Place the Support Bar on top of the Back Panels and attach the Counter Top to the tops of the Panels and Support Bar with Velcro.

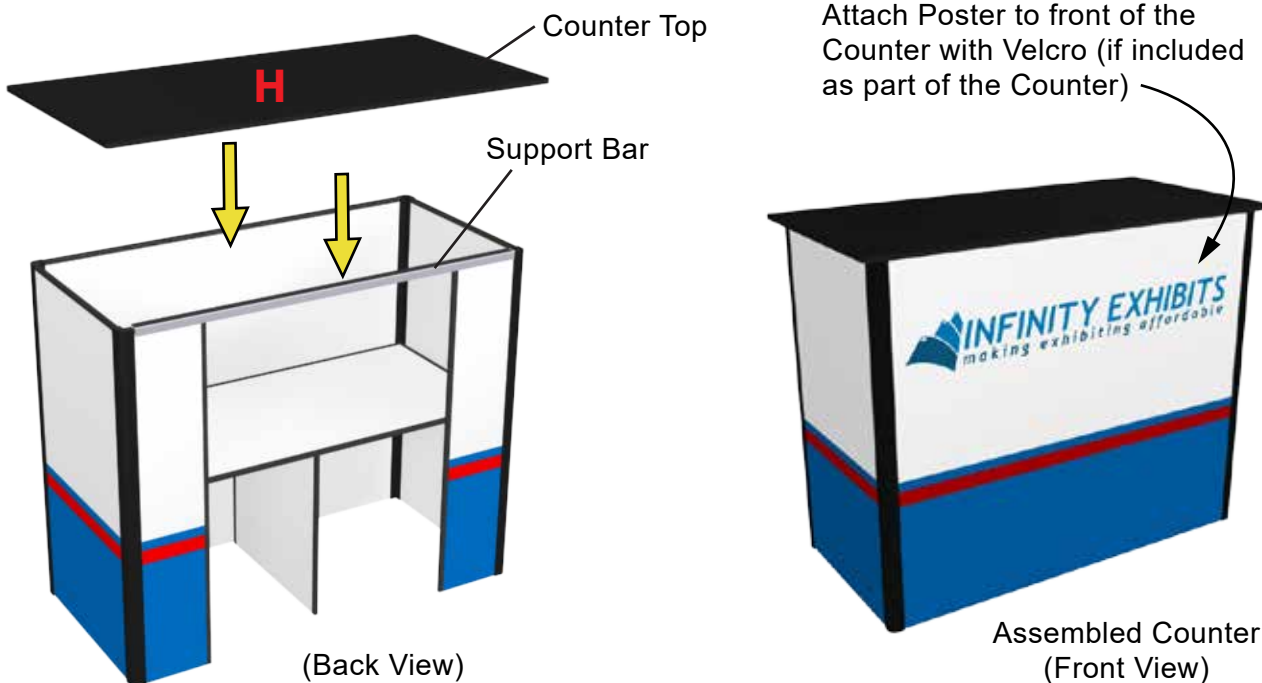

**Case Layout**

Divide the booth components for the 10'x20' Booth and pack the Tub in the following manner:



**Tub**

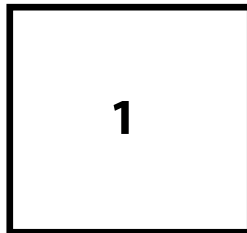

**Booth Components**

- |                   |                      |
|-------------------|----------------------|
| 1) Gridwall       | 9) Pillar Supports   |
| 2) Storage Frames | 10) Poster Box       |
| 3) Support bars   | 11) Instruction Book |
| 4) Shelving       | 12) Light Sticks     |
| 5) Hanging Bars   | 13) Zip Ties         |
| 6) Power Supplies | 14) Signs            |
| 7) Wall Panels    | 15) Lights           |
| 8) Pillars        | 16) Pedestal         |