



## Display Setup Instructions



10' x 20' Display Booth



10' x 10' Display Booth



14" x 14" Pillar  
**2**

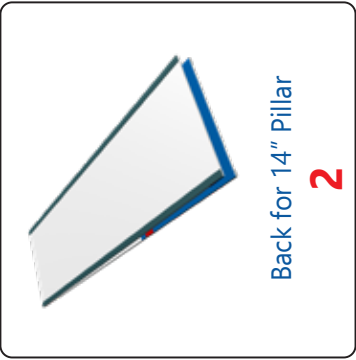

Back for 14" Pillar  
**2**



9" x 14" Pillar  
**3**

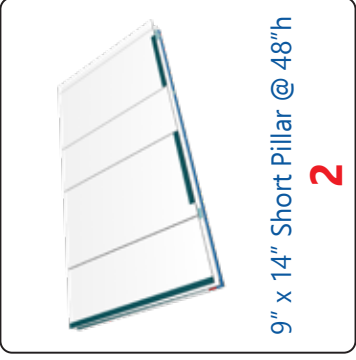

9" x 14" Short Pillar @ 48" h  
**2**

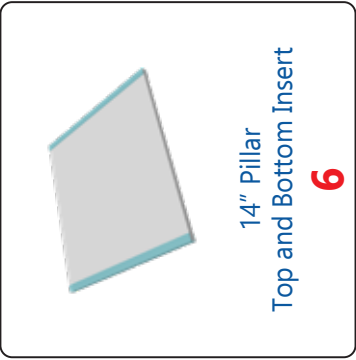

14" Pillar  
Top and Bottom Insert  
**6**

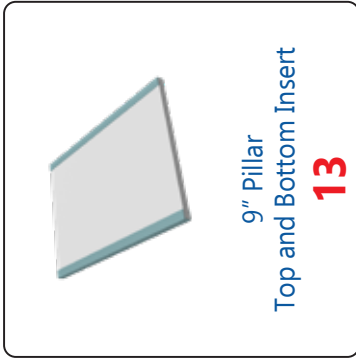

9" Pillar  
Top and Bottom Insert  
**13**

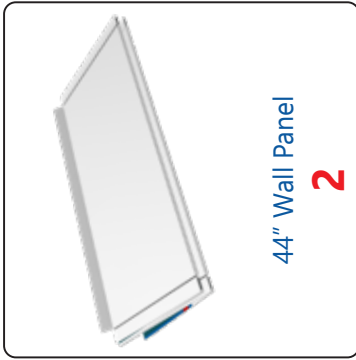

44" Wall Panel  
**2**



40" Wall Panel  
**2**

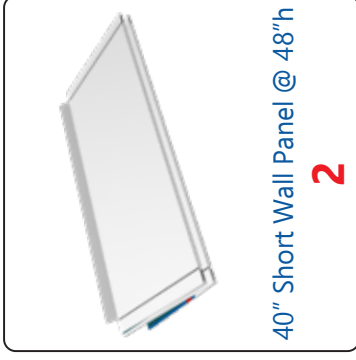

40" Short Wall Panel @ 48" h  
**2**

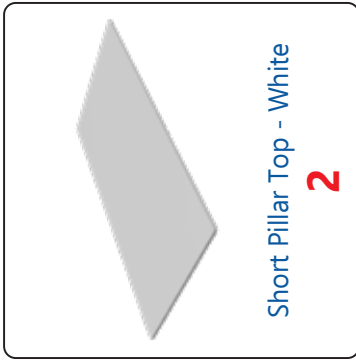

Short Pillar Top - White  
**2**



Large Sign  
**1**

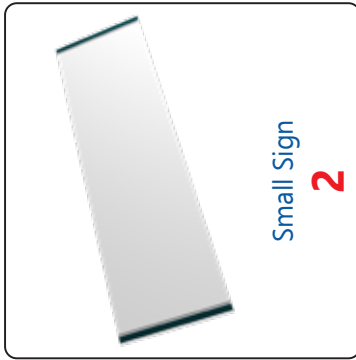

Small Sign  
**2**



44 $\frac{1}{4}$ " Shelf  
**6**

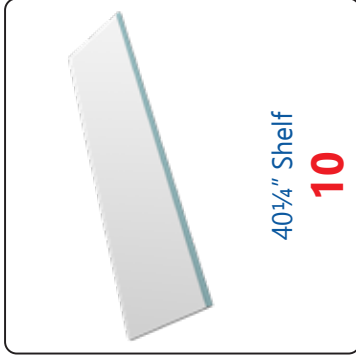

40 $\frac{1}{4}$ " Shelf  
**10**

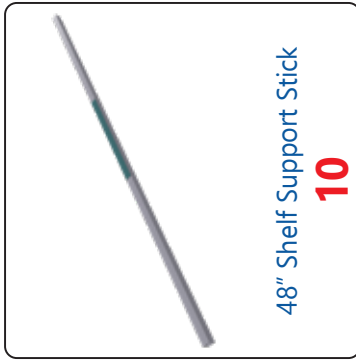

48" Shelf Support Stick  
**10**

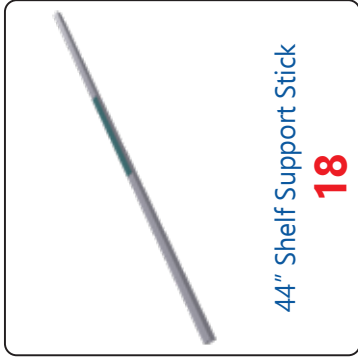

44" Shelf Support Stick  
**18**

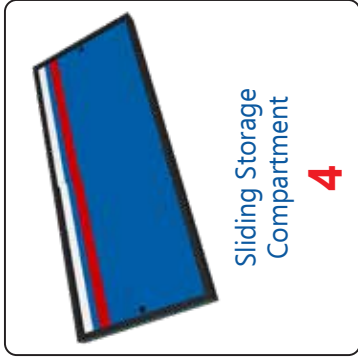

Sliding Storage Compartment  
**4**



White Stem Light - SL526D  
**6**



Light Support & Clip  
**6**



Power/Extension Cord  
**2**

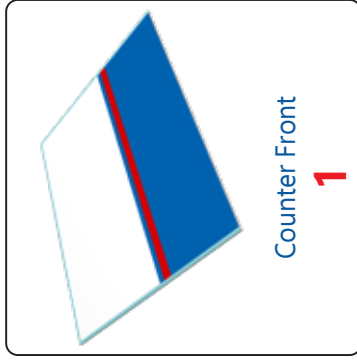

Counter Front  
**1**

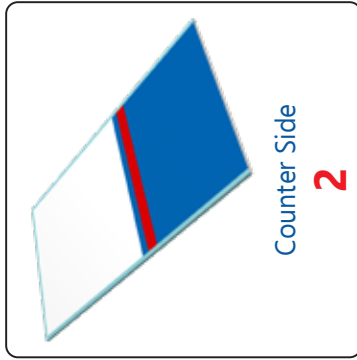

Counter Side  
**2**

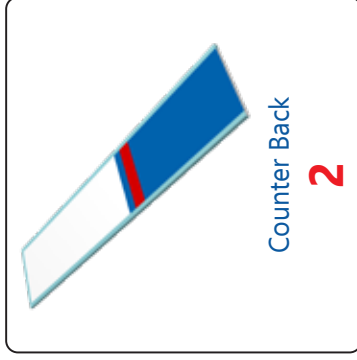

Counter Back  
**2**

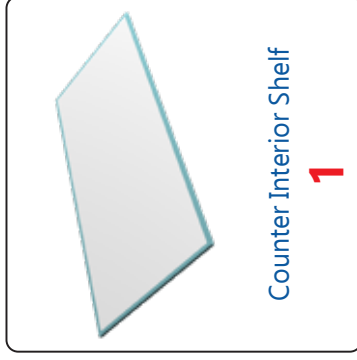

Counter Interior Shelf  
**1**

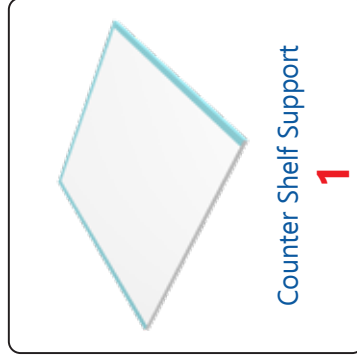

Counter Shelf Support  
**1**

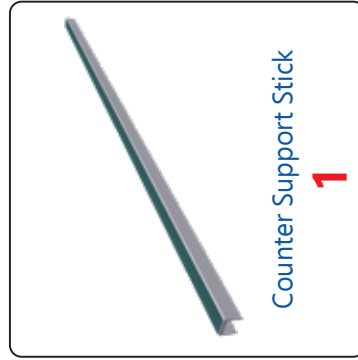

Counter Support Stick  
**1**

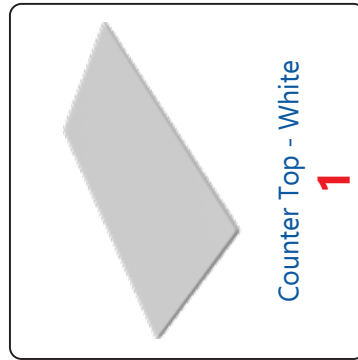

Counter Top - White  
**1**

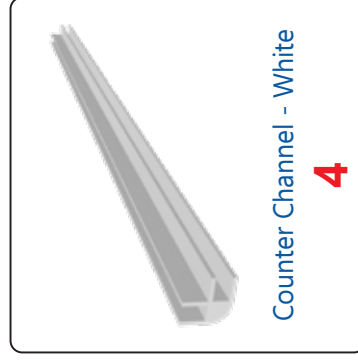

Counter Channel - White  
**4**



Graphic Stand off  
**3**



### Steps to Assemble the InfiniLite Multi Section Exhibit Booth:

- Step 1: Assemble the Corner Pillars, Middle Pillar, and Short Pillars.
- Step 2: Place Pillars upright in their proper order.
- Step 3: Attach Wall Panels to Pillars.
- Step 4: Install the Shelf Support Bars.
- Step 5: Install the Storage Doors.
- Step 6: Attach Shelves to Shelf Support Bars with Velcro.
- Step 7: Attach the front posters to the short pillars with Velcro.
- Step 8: Attach Large Sign and Graphic to Pillars with Velcro.
- Step 9: Attach Stem Lights to the tops of the Pillars.
- Step 10: Assemble the Counter and place it within the booth area.

Enter the link below for an instructional video:

<https://www.youtube.com/watch?v=S8GxFm7gca4>

Assemble the Pillars.

A) Unfold the Pillar Panels with the front sides facing downward.

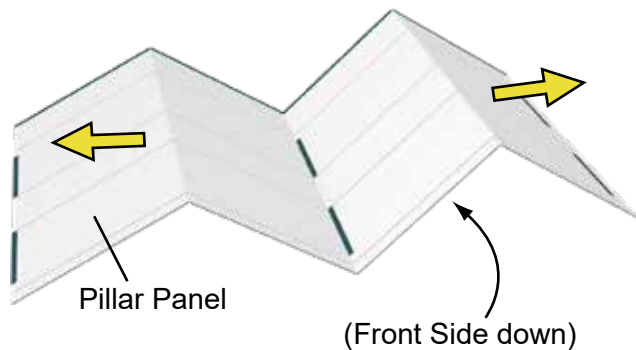

B) Attach the Top, Middle and Bottom Supports to the back of the Pillars with Velcro.

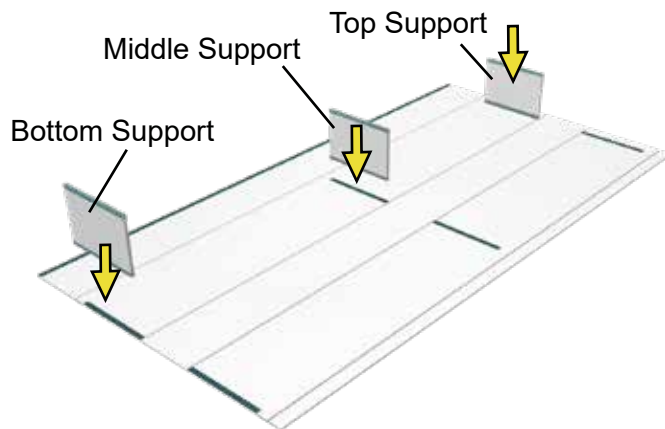

C) Fold Pillar around the Supports and attach with Velcro.

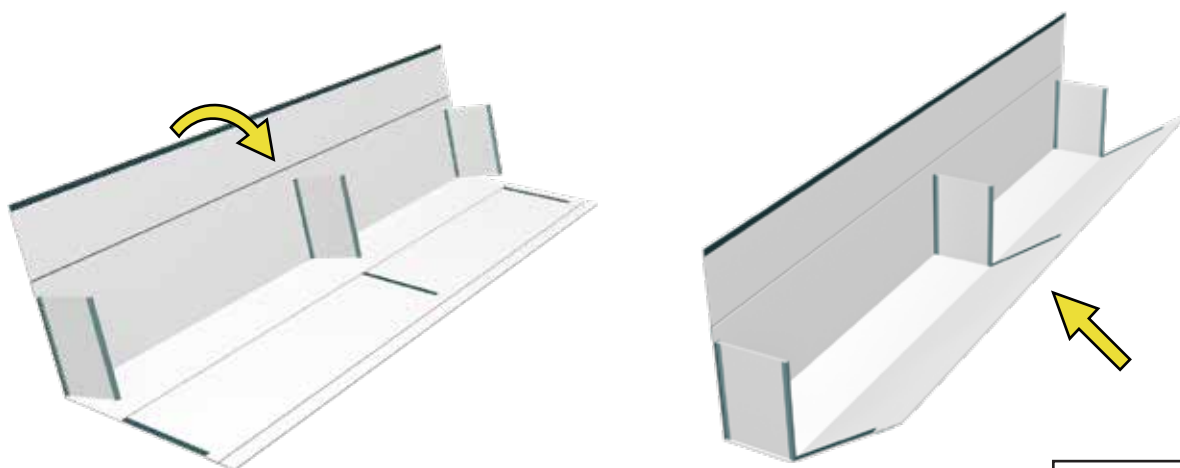

D) Close the Pillar using the Velcro strips along the Pillar edges.

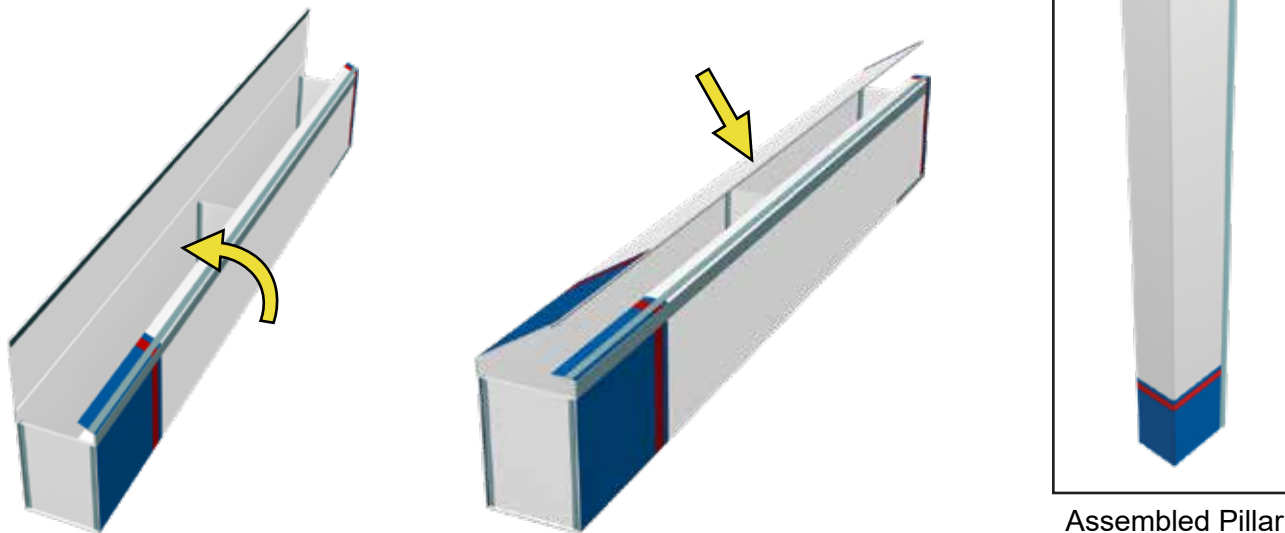

**Assemble Corner Pillars.**

A) Unfold the Corner Pillar Panels with the front sides facing downward.

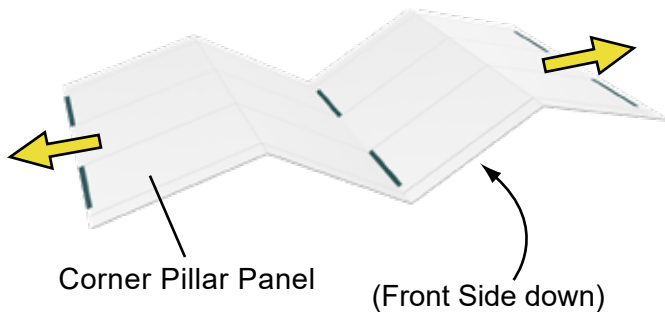

B) Attach the Top, Middle and Bottom Supports to the back of the Corner Pillars with Velcro.

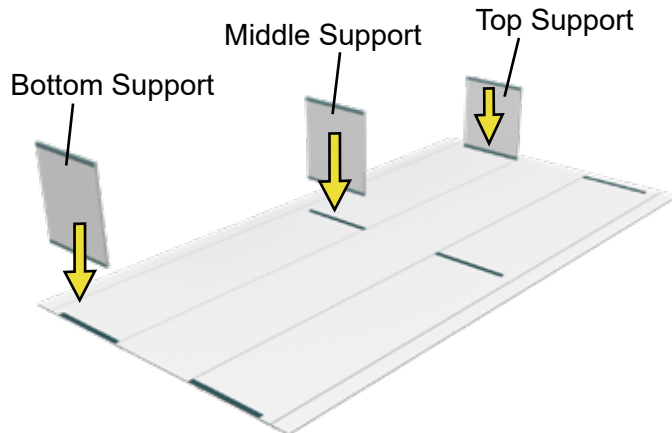

C) Fold the Corner Pillar around the Supports and attach with Velcro.

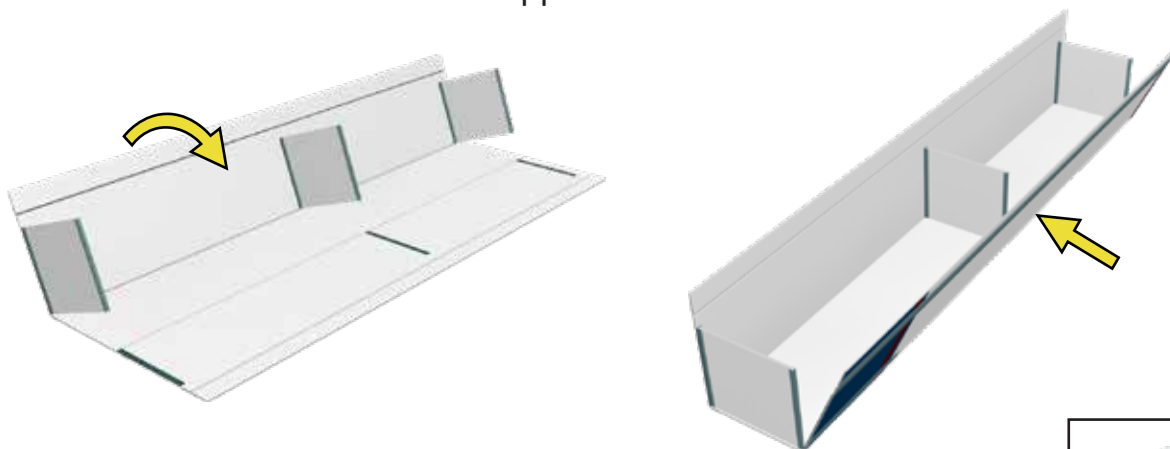

D) Attach the Back Cover to the bottom half of the Corner Pillar with Velcro; unfold the Back Cover; then attach the remaining Back Cover to the upper half of the Corner Pillar.

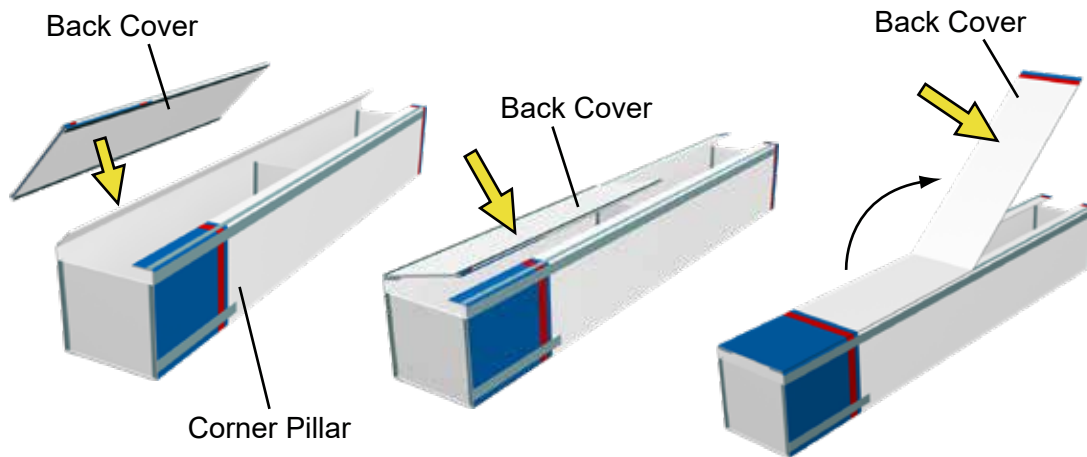

**Assembled Corner Pillar**

Assemble the Short Pillars.

A) Unfold the Short Pillar Panels with the front sides facing downward.

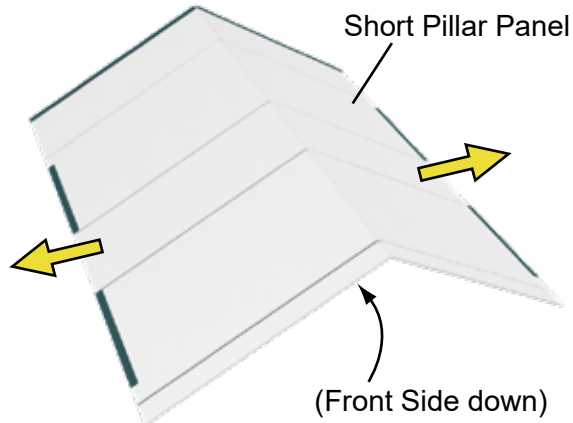

B) Attach Top and Bottom Supports to the back of the Short Pillars with Velcro.

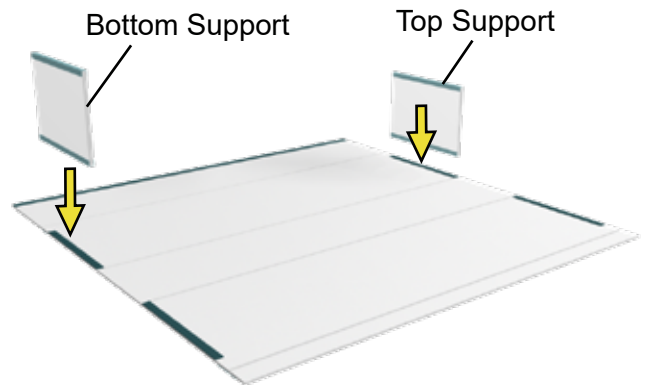

C) Fold Short Pillar around the Top and Bottom Supports and attach with Velcro.

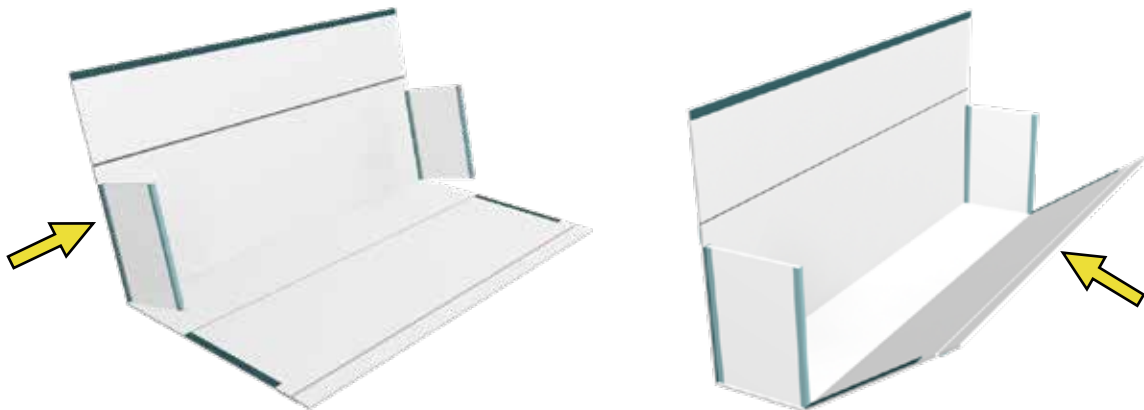

D) Close the Short Pillar using the Velcro strips along the edges.

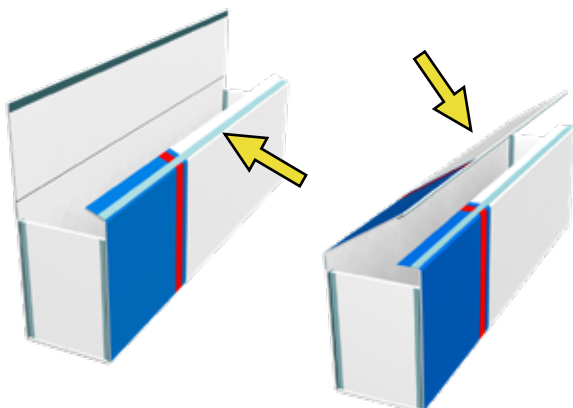

E) Attach Pillar Top to the Short Pillar with Velcro.

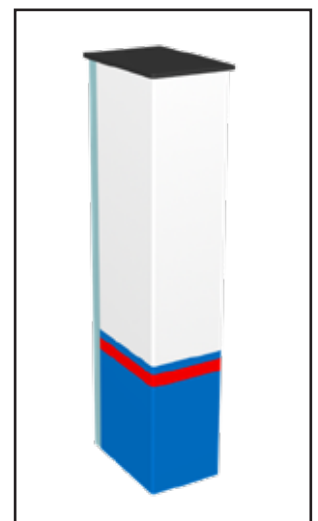
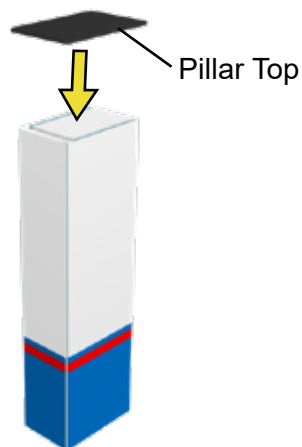

Assembled Short Pillar

# Assembly Instructions: InfiniLite 20-08

Place Pillars upright in their proper order.

A) The following Floor Plan identifies the locations of the Booth Components:

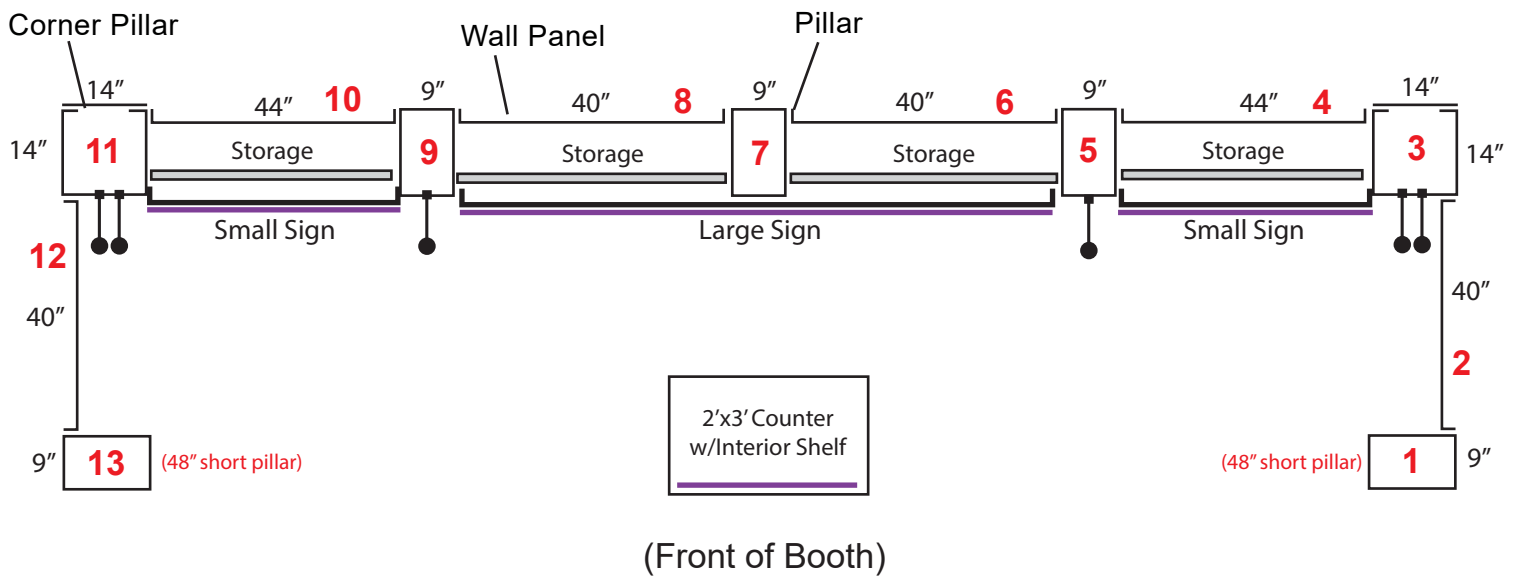

## LEGEND

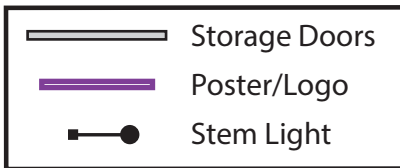

**TOP VIEW**  
Floor Plan A:  
10'x20'

B) Place the assembled Pillars in their assigned locations as numbered and indicated on the Floor Plan.

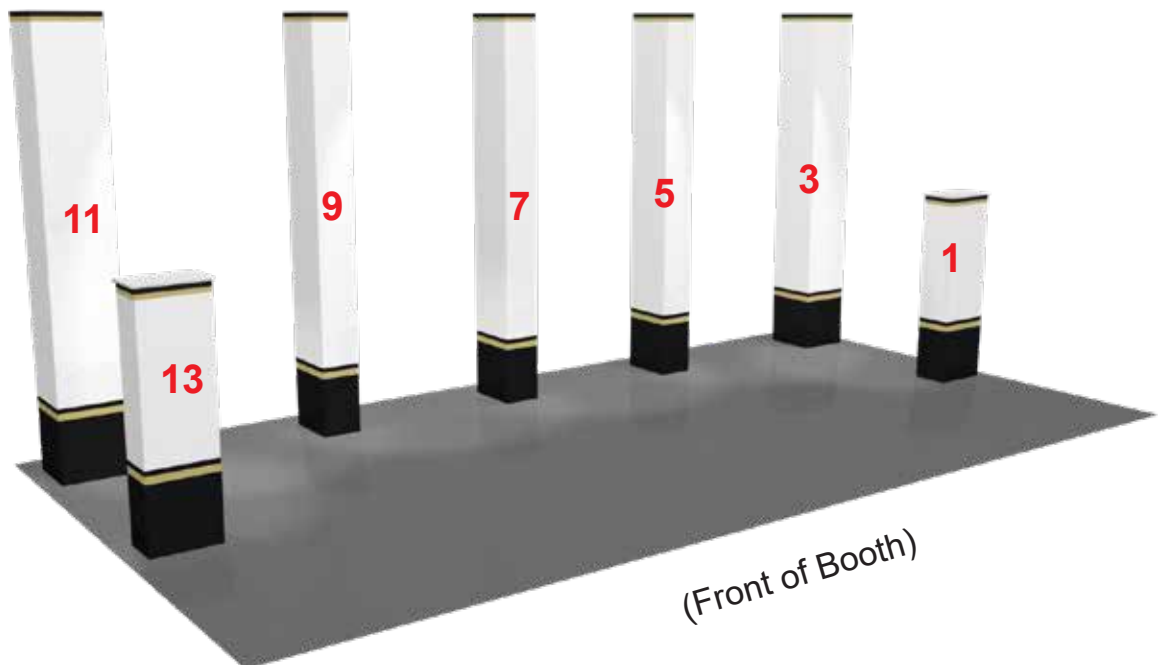

## Assembly Instructions: InfiniLite 20-08

Place Pillars upright in their proper order.

A) The following Floor Plan identifies the locations of the Booth Components:

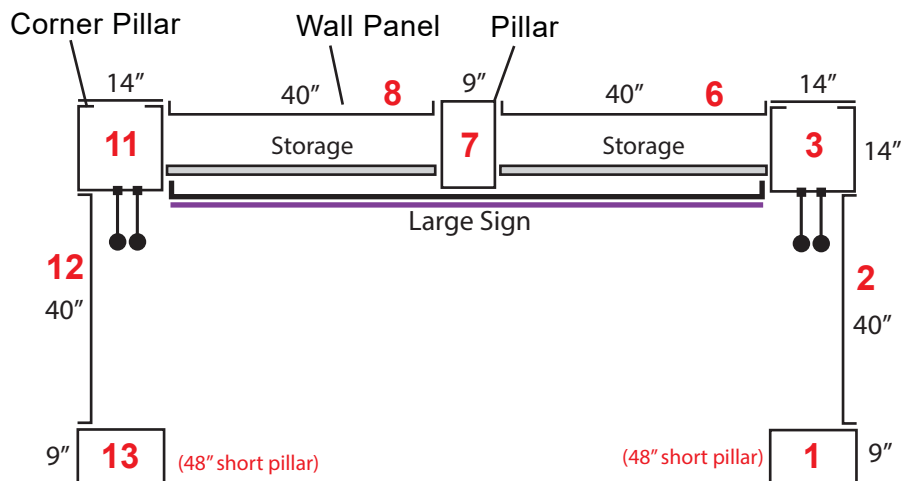

### LEGEND

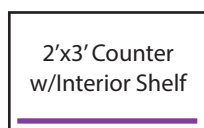
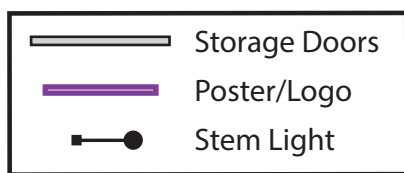

(Front of Booth)

**TOP VIEW**  
**Floor Plan B:**  
**10'x10'**

B) Place the assembled Pillars in their assigned locations as numbered and indicated on the Floor Plan.

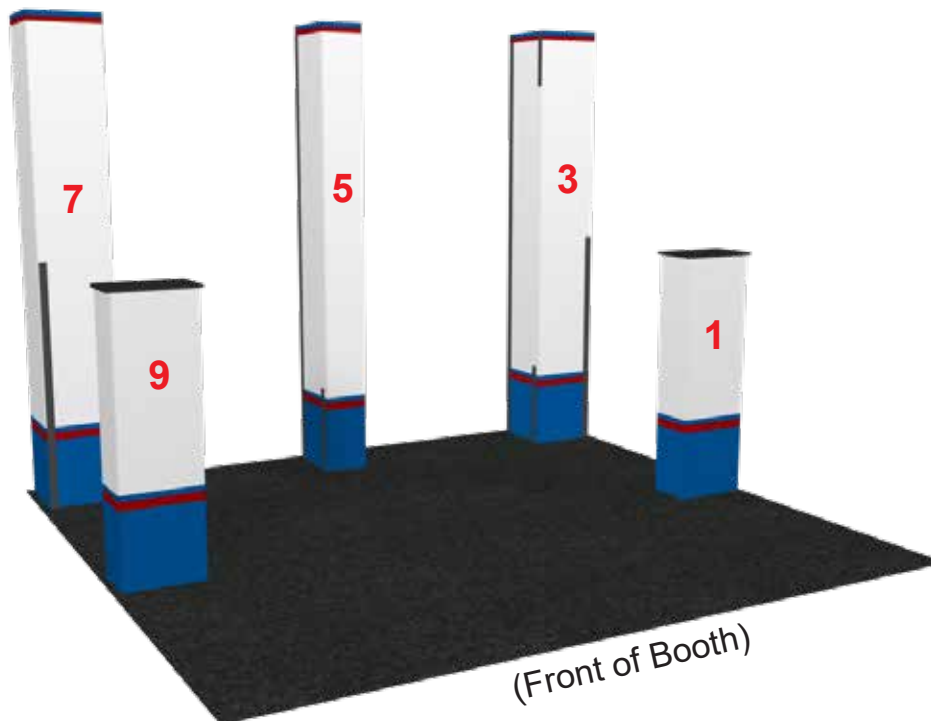

Attach Wall Panels to Pillars.

A) Unfold the bottom half of the Wall Panel, hold upright and attach to the side of the Pillar with Velcro. (Make sure that the Pillar and Wall Panel are flat on the floor surface when attaching and that the accent stripes are aligned with each other.) Begin assembly from either the left or right side of the Booth.

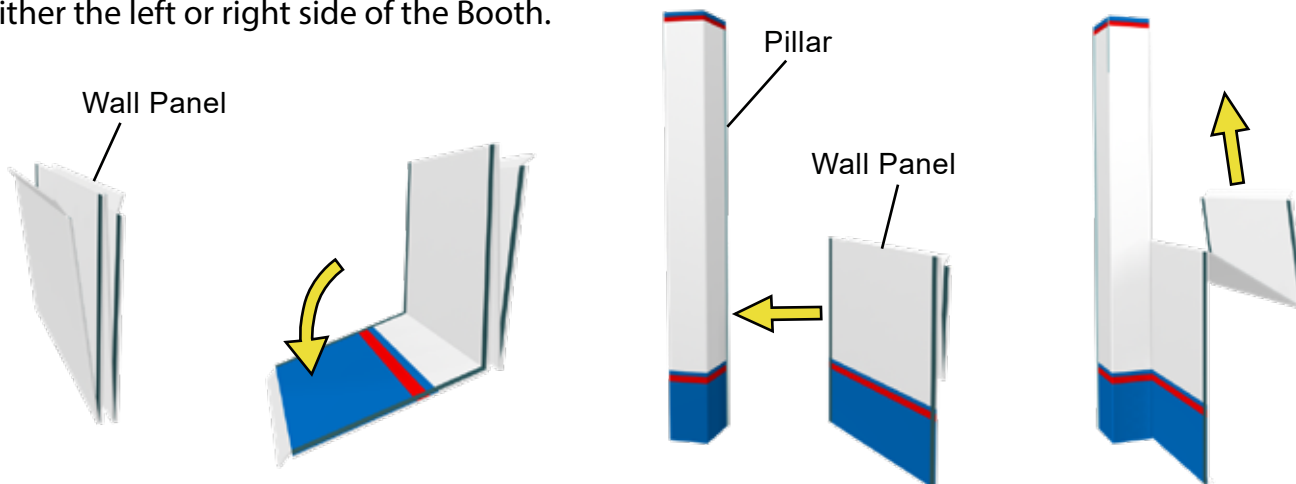

B) Unfold the top half of the Wall Panel and attach it to the top half of the Pillar matching the Velcro strips along the edges. Rotate the Wall Panel into position. Attach the next Pillar to the Wall Panel so that it is flat against the front face of the Wall Panel. Rotate the Pillar into position.

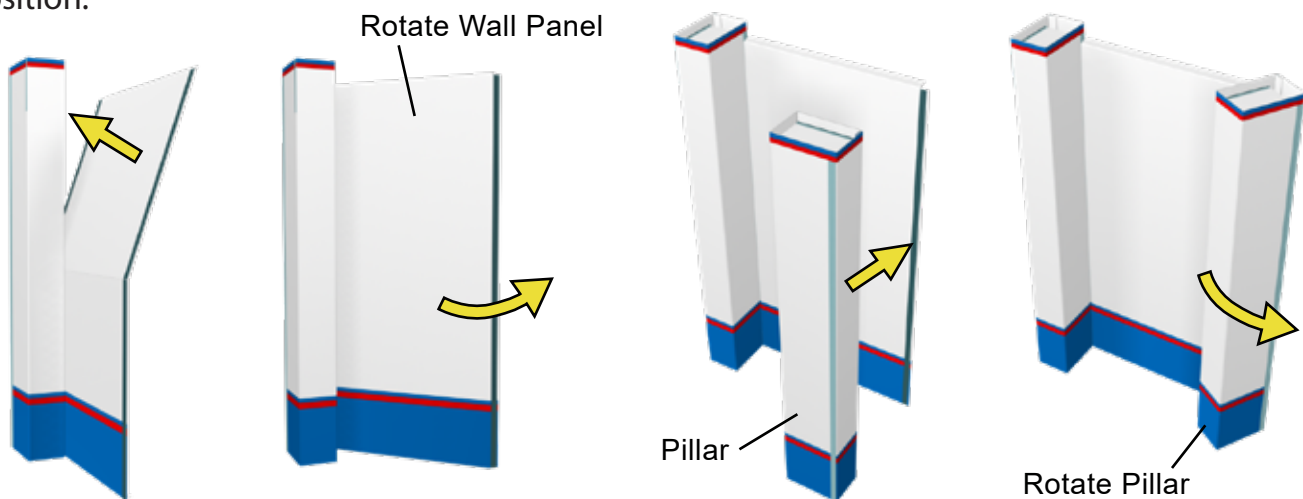

C) Repeat this process with the remaining Wall Panels and Pillars.

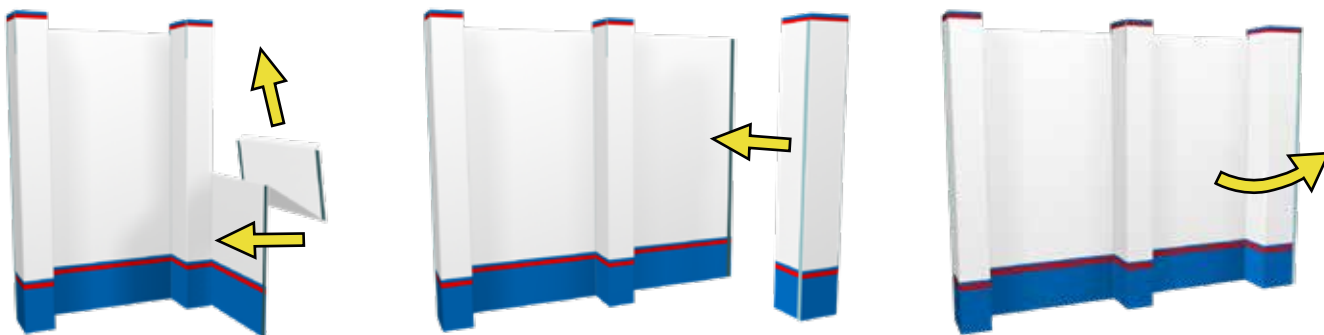

Attach Short Wall Panel to Pillars.

A) Unfold the Short Wall Panel, hold upright, and attach to Pillar with Velcro. (Make sure that the bottoms of the Pillar and Short Wall Panel are flat against the floor when attaching and that the accent stripes are aligned with each other.)

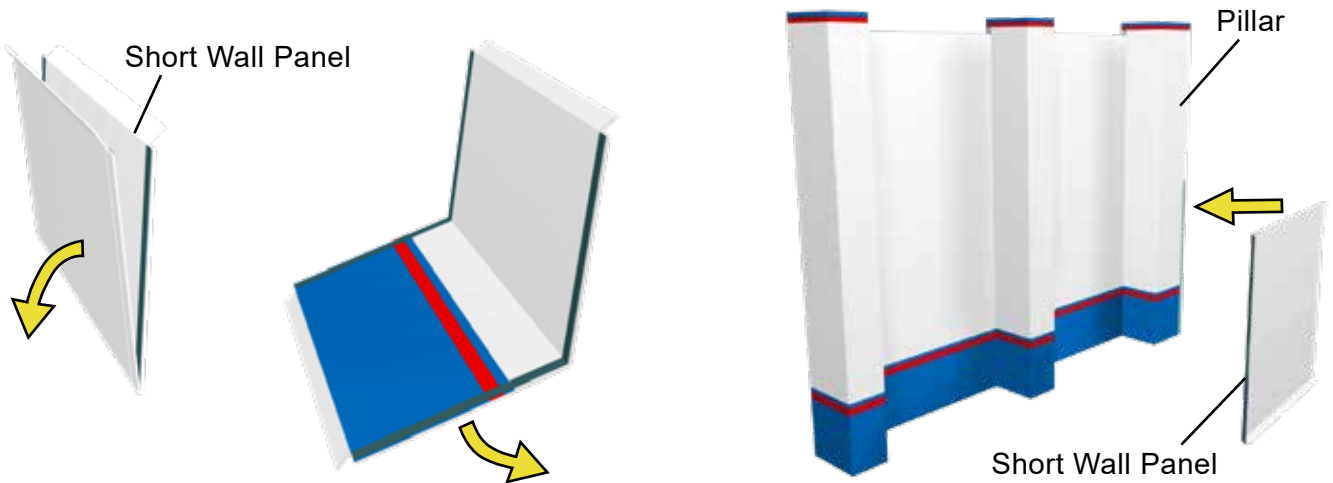

B) Rotate the Short Wall Panel into position. Attach the Short Pillar to the Short Wall Panel so that it is flat against the front face of the Short Wall Panel. Rotate the Pillar into position.

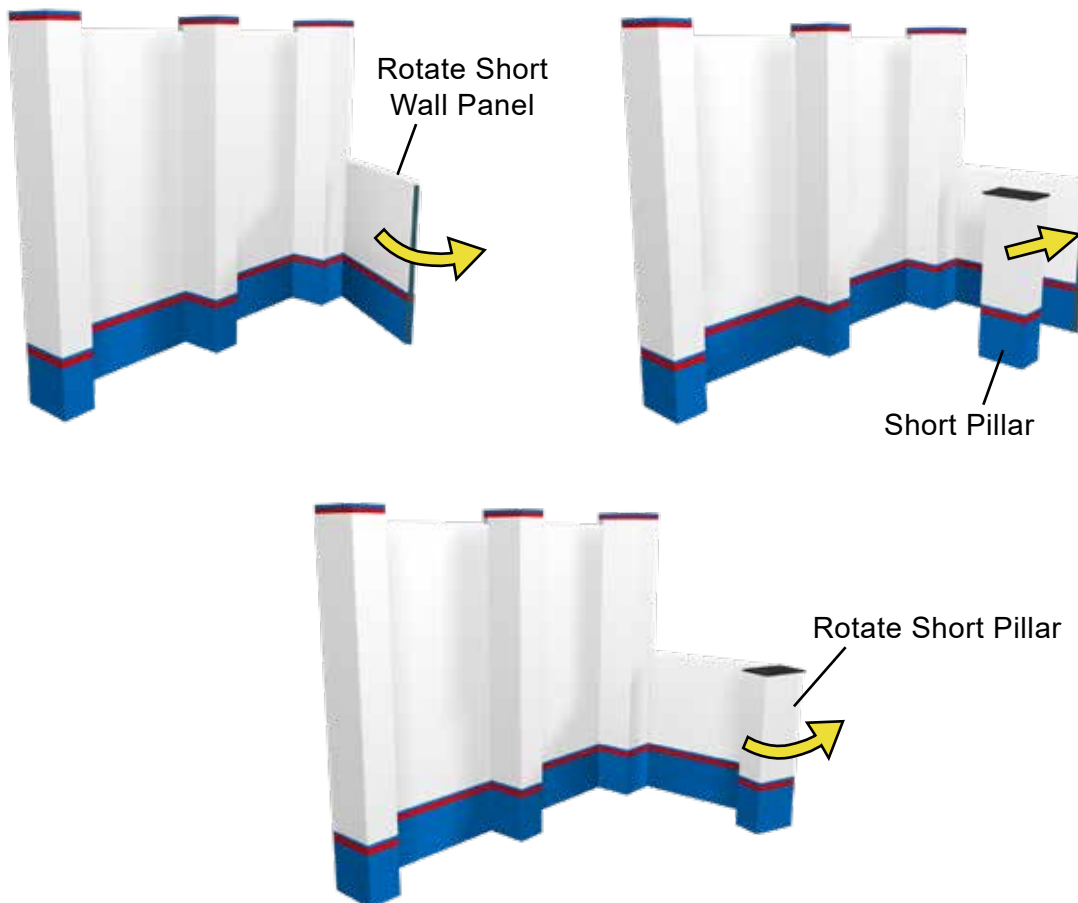

## Assembly Instructions: InfiniLite 20-08

Install the Shelf Support Bars.

A) Insert the shelf support bars into the designated openings in the Pillars.

**Make sure that the Velcro on the bars is facing upward to attach the shelves.**

**NOTE:** Images on this page show typical installation of Shelf Support Bars, Storage Doors and Shelves.



Install Storage Doors. (Attach Storage Doors to the inside of the Pillars with Velcro.)



Attach Shelves to Shelf Support Bars and top of Storage Doors with Velcro.

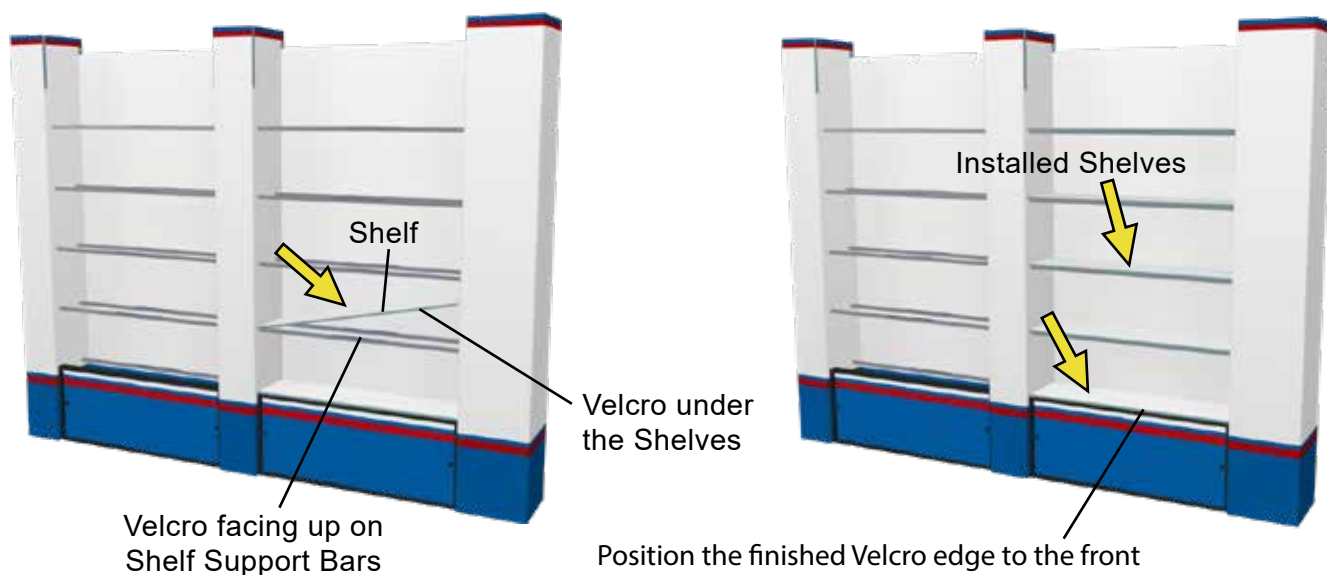

## Assembly Instructions: InfiniLite 20-08

Assemble Signs and attach to Pillars with Velcro.

A) Unfold the Large Signs and Corner Signs. (The Small Signs are not folded in half.)



B) Fold down the top sections of the Sign along the flutes to form a triangle and Velcro closed.

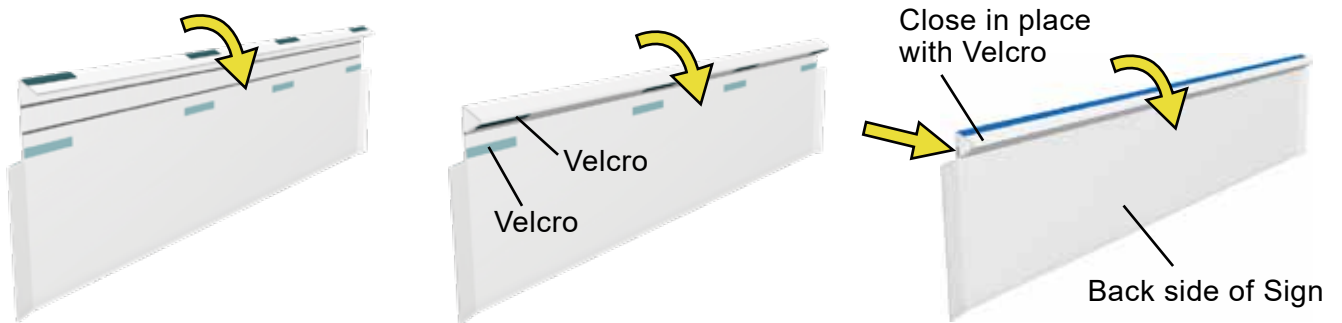

C) Attach Signs to Pillars with Velcro.



(NOTE: The Header Poster attaches to the Large Sign with Velcro.)

(NOTE: The Header Poster attaches to the front of the Small Sign with Velcro.)

D) Attach the Logo Stand-offs to the Signs with Velcro.



## Assembly Instructions: InfiniLite 20-08

Attach the Stem Lights to the tops of the Pillars.

A) Place a wooden Light Support Stick on top of the proper Pillars as shown. (Use a ladder or step stool to access the top of the Pillar.) Secure the Stick to the back of the Pillar with a Binder Clip.

B) Attach the Stem Light to the front end of the Pillar and Support Stick by adjusting the thumbscrew on the back of the Stem Light. (DO NOT overtighten the thumbscrew. Overtightening the adjustment thumbscrew may damage the Pillar.)

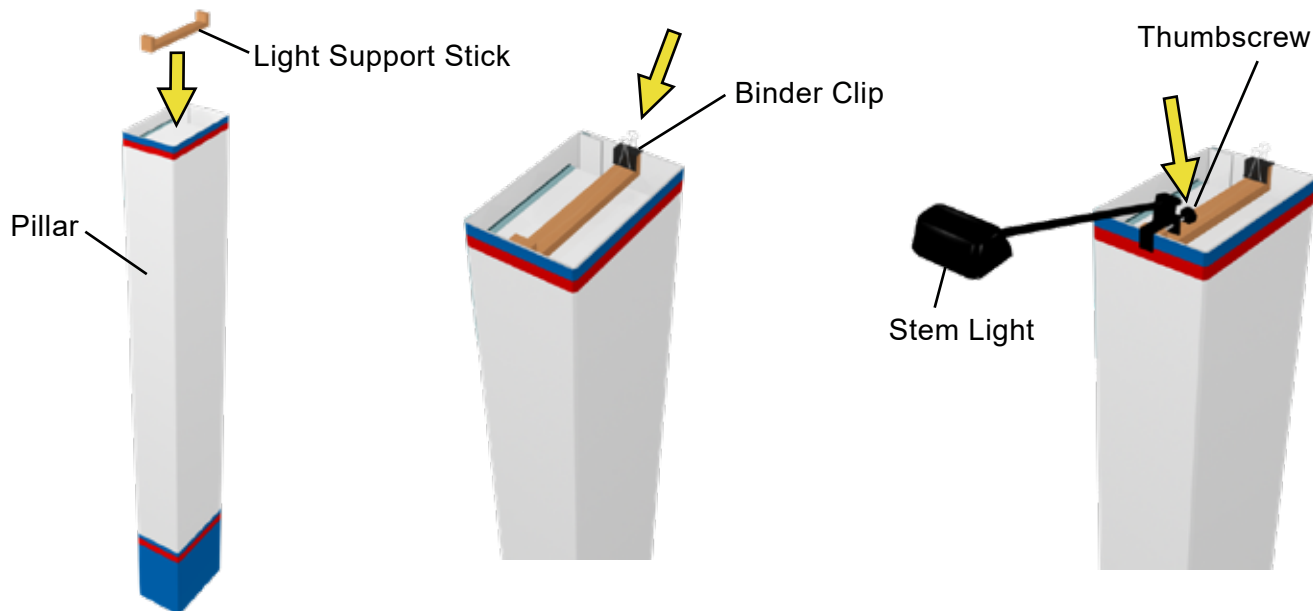

Counter Assembly:

A) Connect the Counter Panels together with the 90° Channels and Velcro. (Make sure that the Velcro is on top to attach the Counter Top.)

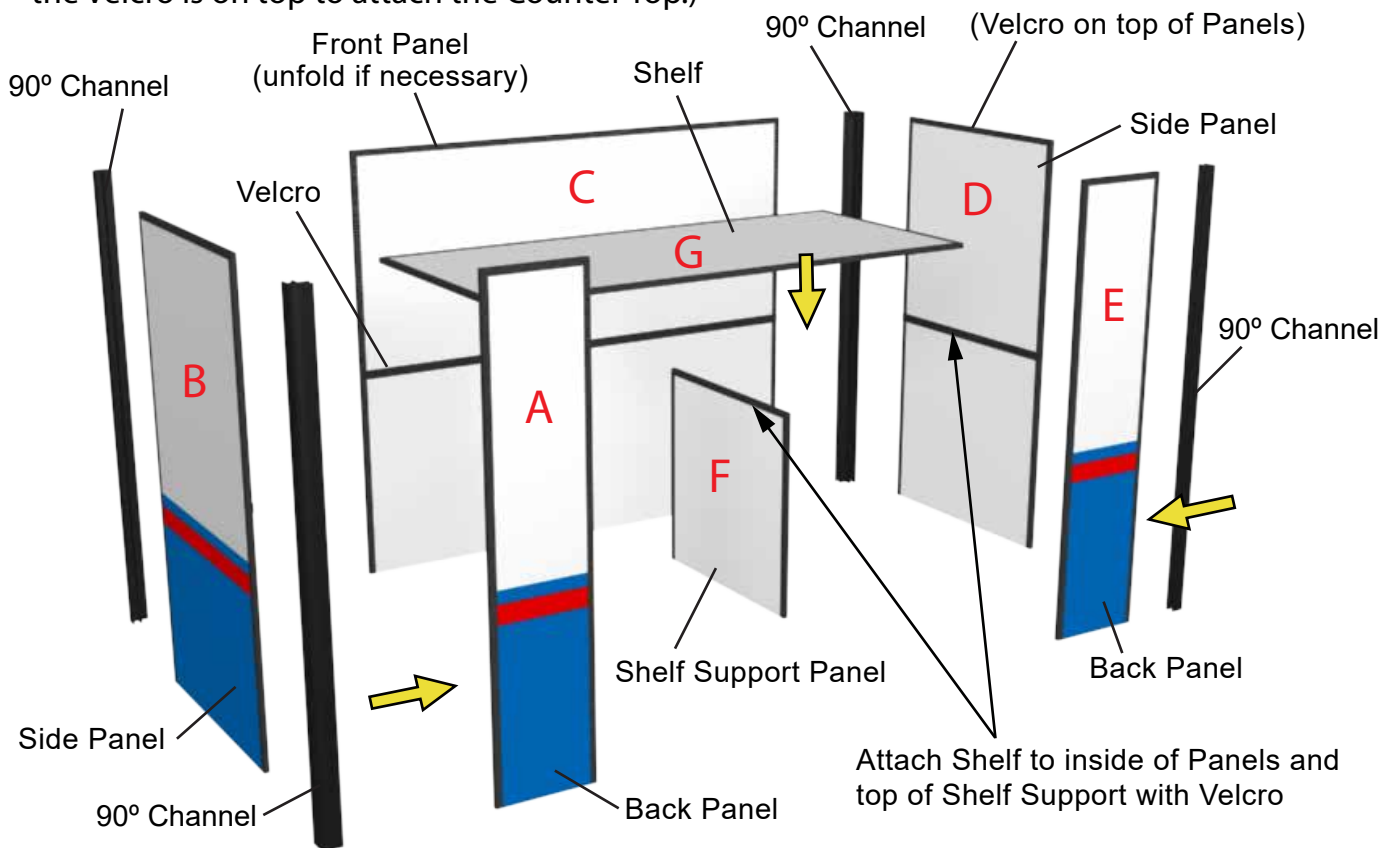

B) Place the Support Bar on top of the Back Panels and attach the Counter Top to the tops of the Panels and Support Bar with Velcro.

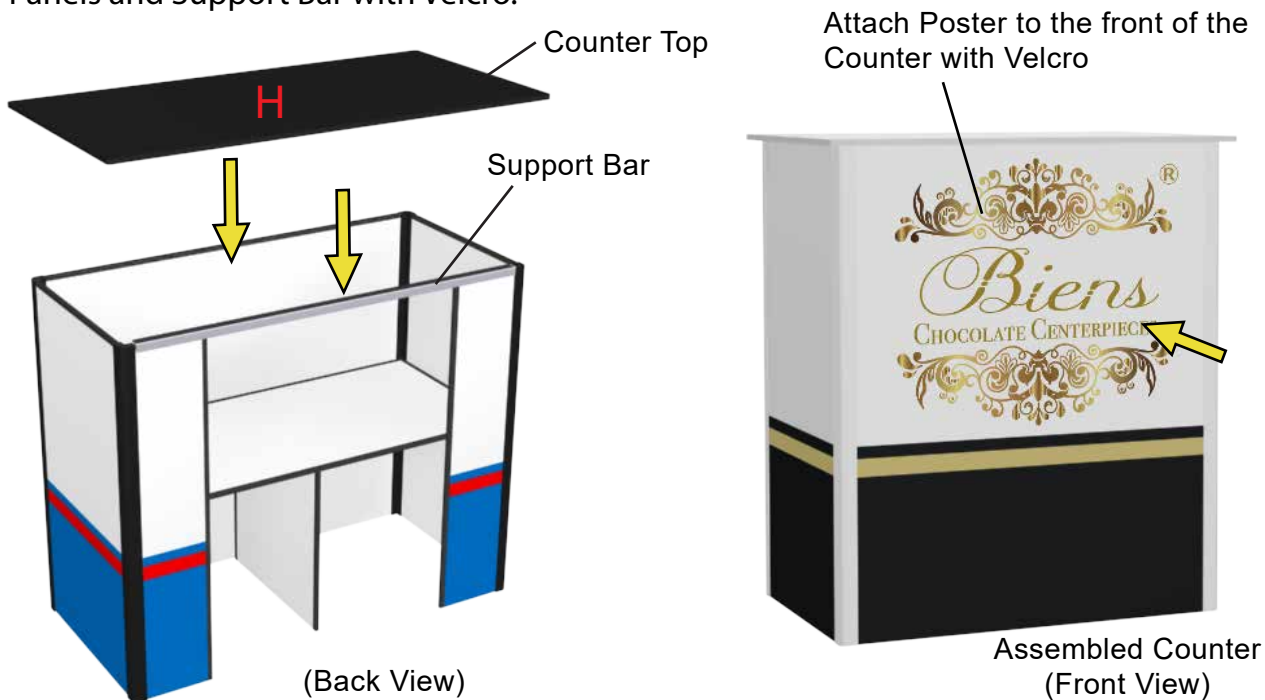

# Assembly Instructions: InfiniLite 20-08

## Case Layout

After disassembling the booth, organize the display components and pack them into the Shipping Cases:

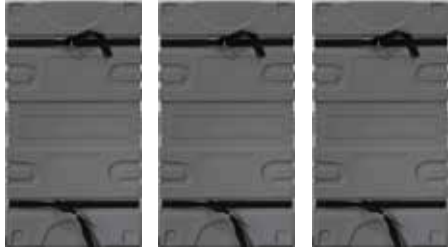

View showing Typical Shipping Cases

10' x 20' Display Booth

Organize the Booth Components in the following manner:

<u>Case</u>	<u>Booth Components</u>	<u>Case</u>	<u>Booth Components</u>
1	<ul style="list-style-type: none"> <li>1) Pillars</li> <li>2) Pillar Backs</li> <li>3) Pillar supports</li> </ul>	3	<ul style="list-style-type: none"> <li>1) Counter Top</li> <li>2) Counter Panels</li> <li>3) Panel Connectors</li> <li>4) Graphics</li> </ul>
2	<ul style="list-style-type: none"> <li>1) Sliding Storages</li> <li>2) Shelf Support Bars</li> <li>3) Stem Lights</li> <li>4) Extension Cords</li> <li>5) Powers Strips</li> </ul>	4	<ul style="list-style-type: none"> <li>1) Wall Panels</li> <li>2) Shelves</li> <li>3) Light support sticks</li> </ul>