

## Assembly Instructions: 10'x10' Multi Section Shelf Display



### Steps to Assemble the InfiniLite Multi Section Exhibit Booth:

- Step 1:** Assemble the Pillars and Corner Pillar.
- Step 2:** Place Pillars upright in their proper order and locations.
- Step 3:** Attach Wall Panels to Pillars.
- Step 4:** Install Storage Doors.
- Step 5:** Install Shelf Support Bars and Light Bars into sides of Pillars.
- Step 6:** Attach Fluorescent Lights to Bars and connect in series.
- Step 7:** Attach Shelves to Shelf Support Bars with Velcro.
- Step 8:** Attach the Posters to the Pillars and Wall Panels.
- Step 9:** Attach the Sign to the inside of the Pillars with Velcro.
- Step 10:** Attach Stem Lights to the top of the Pillars.
- Step 11:** Assemble the Counter and place it within the Booth area.

## Assembly Instructions: 10'x10' Multi Section Shelf Display

### Assemble the Pillars. (Pillars are identified with numbers.)

A) Unfold the Pillar Panels with the front sides facing downward.

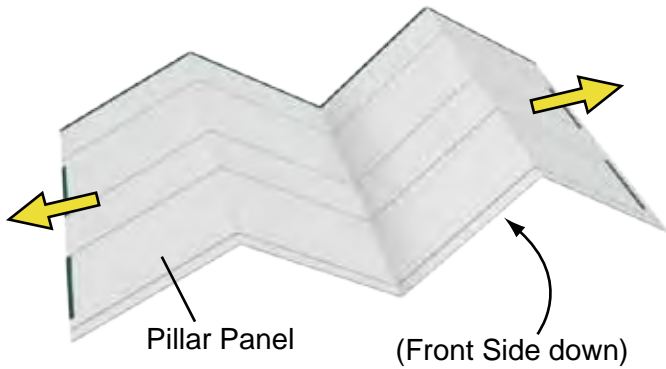

B) Attach Top and Bottom Supports to the back of the Pillars with Velcro.

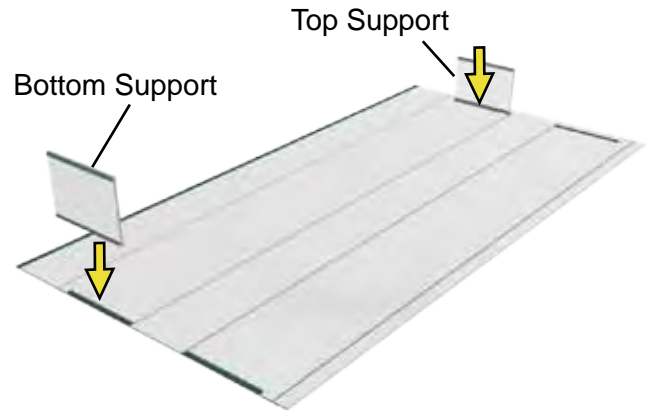

C) Fold Pillar around the Supports and attach with Velcro.

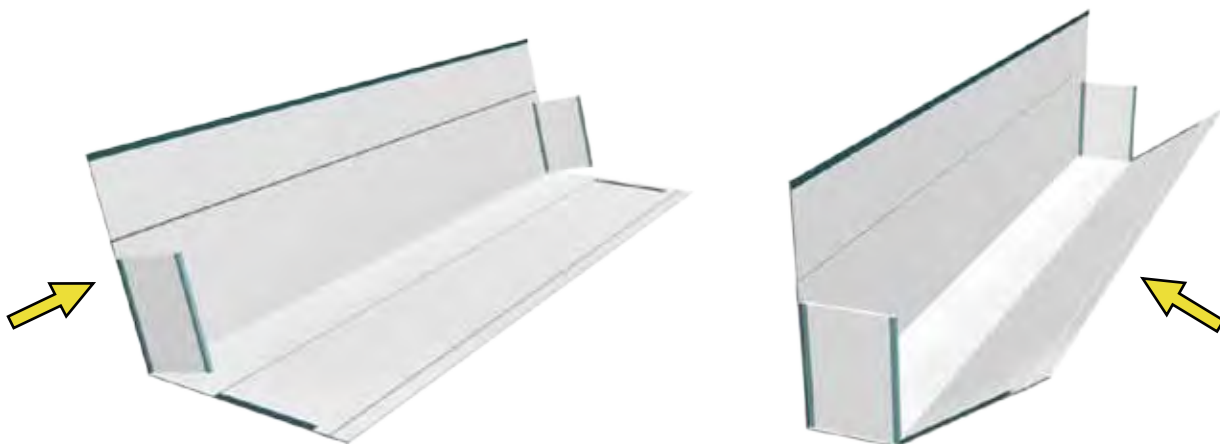

D) Close the Pillar using the Velcro strips along the Pillar edges.

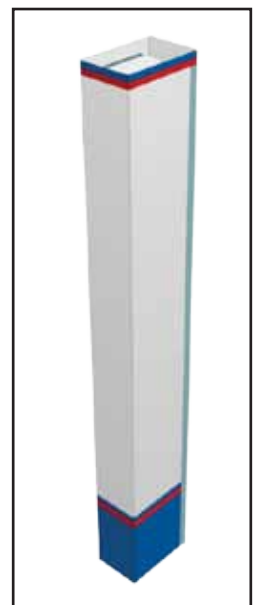
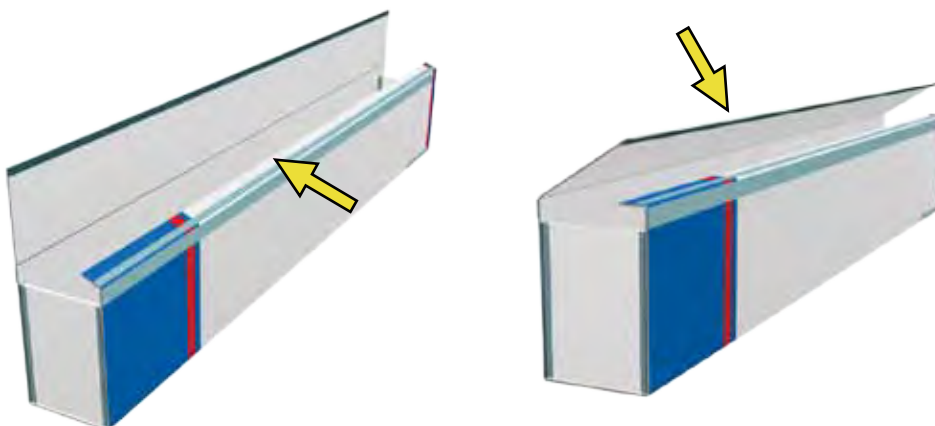

Assembled Pillar

## Assembly Instructions: 10'x10' Multi Section Shelf Display

### Assemble the Corner Pillar.

E) Unfold the Corner Pillar Panel with the front sides facing downward.

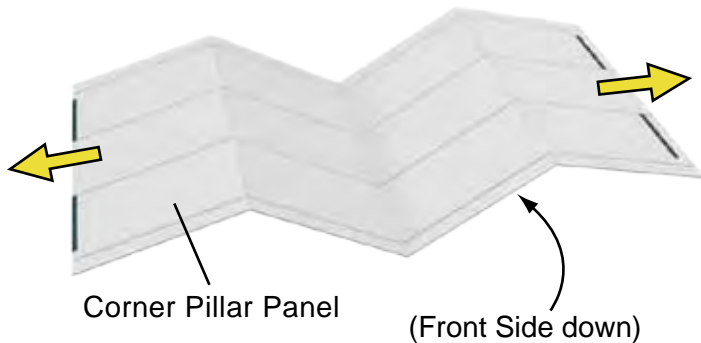

F) Attach Top and Bottom Supports to the back of the Corner Pillars with Velcro.

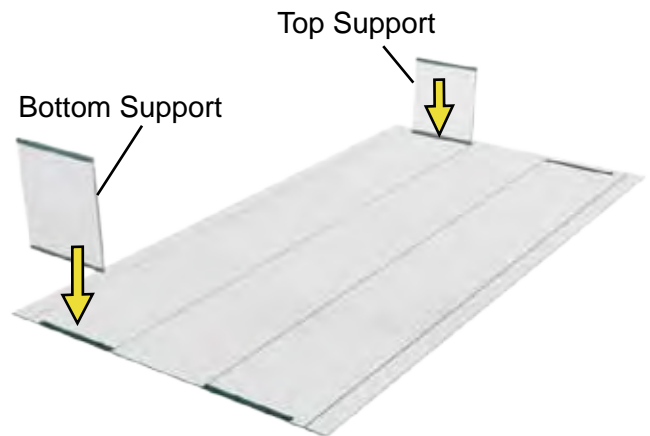

G) Fold the Corner Pillar around the Supports and attach with Velcro.



H) Attach the Back Cover to the bottom half of the Corner Pillar with Velcro; unfold the Back Cover; then attach the remaining Back Cover to the upper half of the Corner Pillar.

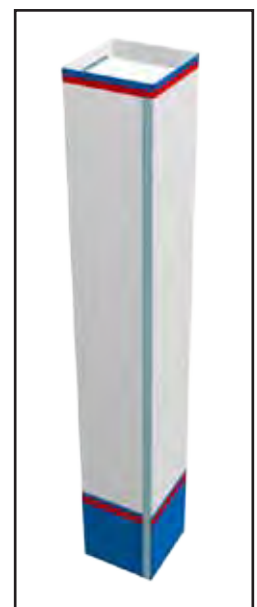
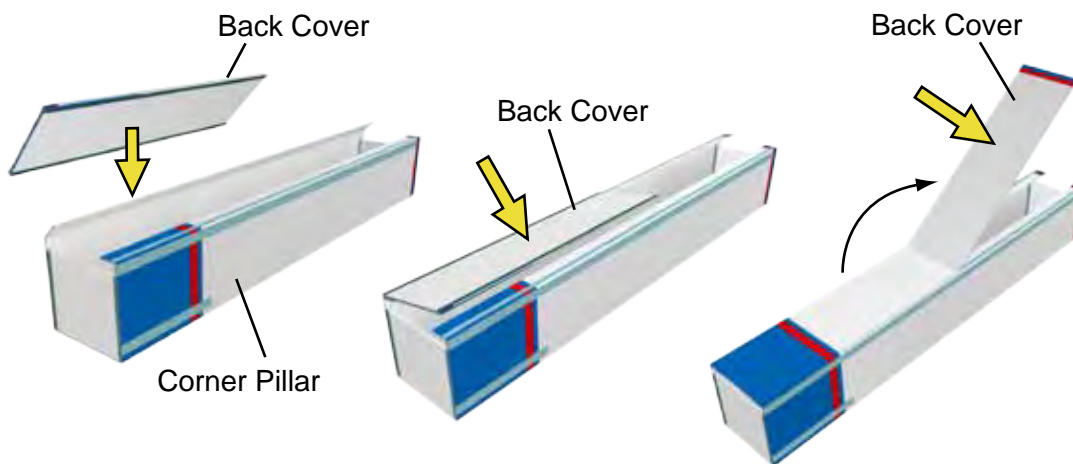

Assembled Corner Pillar

## Assembly Instructions: 10'x10' Multi Section Shelf Display

### Assemble the Short Pillar.

A) Unfold the Short Pillar Panel with the front sides facing downward.

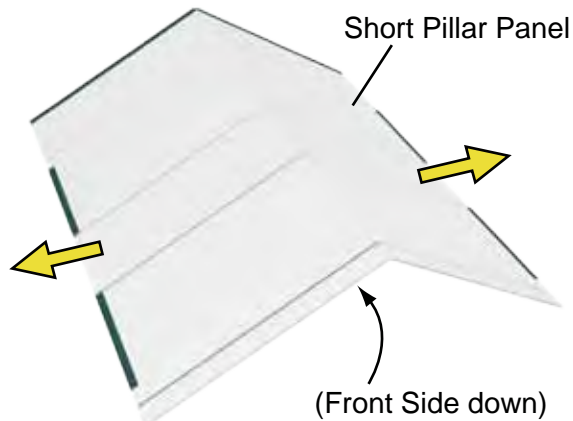

B) Attach Top and Bottom Supports to the back of the Short Pillar with Velcro.

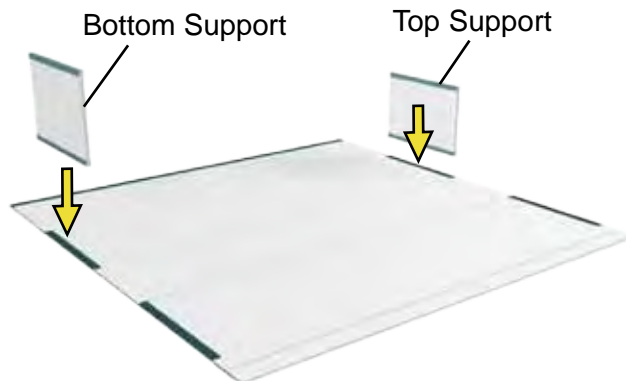

C) Fold Short Pillar around the Top and Bottom Supports and attach with Velcro.

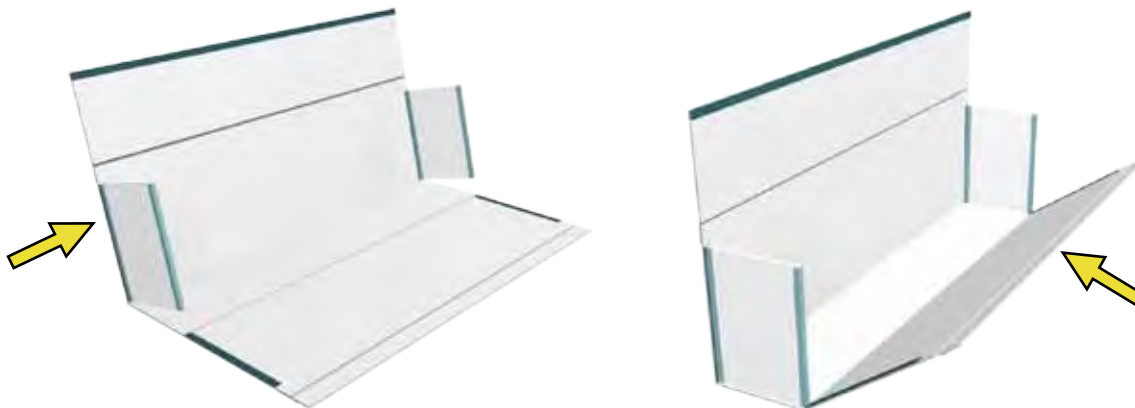

D) Close the Short Pillar using the Velcro strips along the edges.

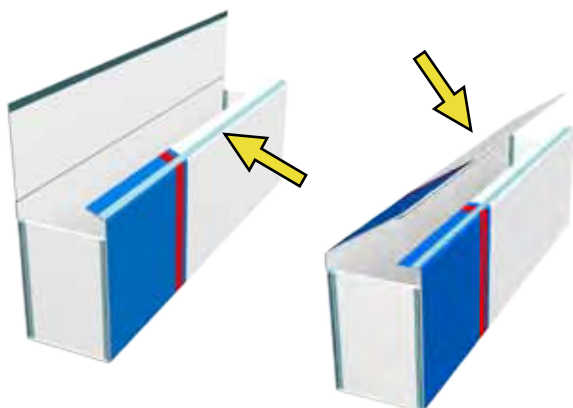

E) Attach Pillar Top to the Short Pillar with Velcro.



Assembled Short Pillar

# Assembly Instructions: 10'x10' Multi Section Shelf Display

The following Floor Plan identifies the locations of the Booth Components:

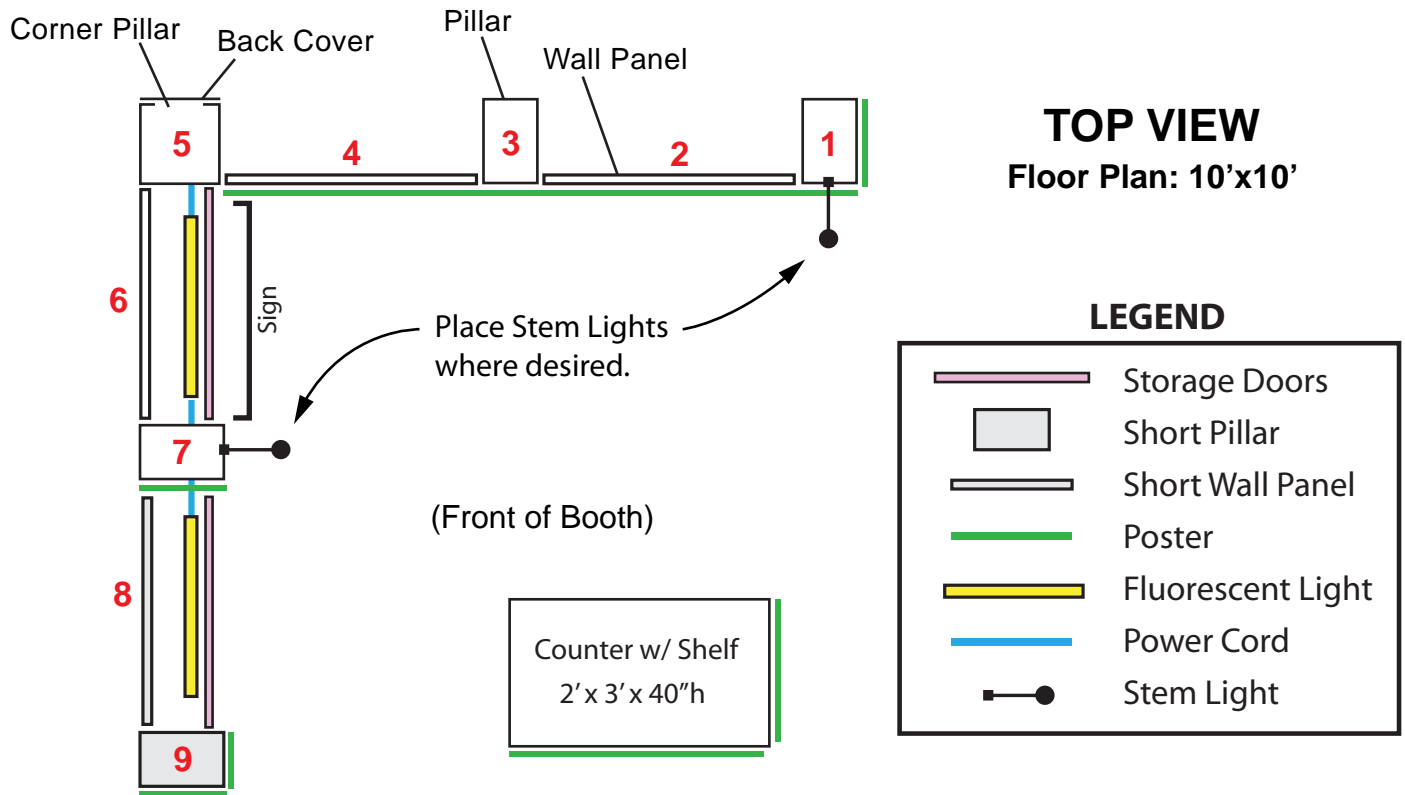

Place the assembled Pillars and Corner Pillar upright in their proper order and assigned locations as numbered and indicated on the Floor Plan.

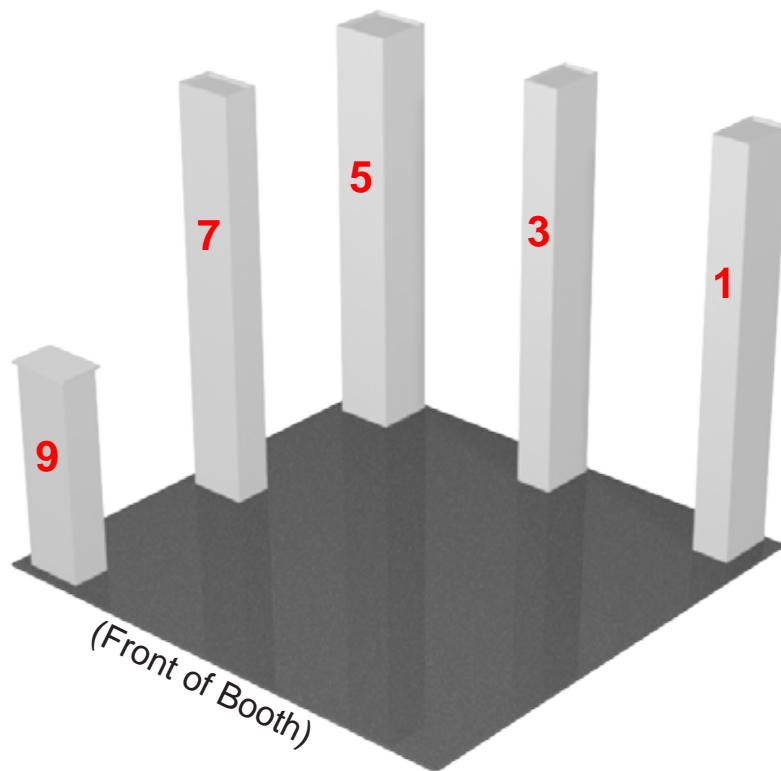

## Assembly Instructions: 10'x10' Multi Section Shelf Display

### Attach Wall Panels to Pillars.

A) Unfold the bottom half of the Wall Panel, hold upright and attach to the side of the Pillar with Velcro. (Make sure that the Pillar and Wall Panel are **flat** on the floor surface when attaching and that the accent stripes are aligned with each other.) Begin assembly from either the left or right side of the Booth.

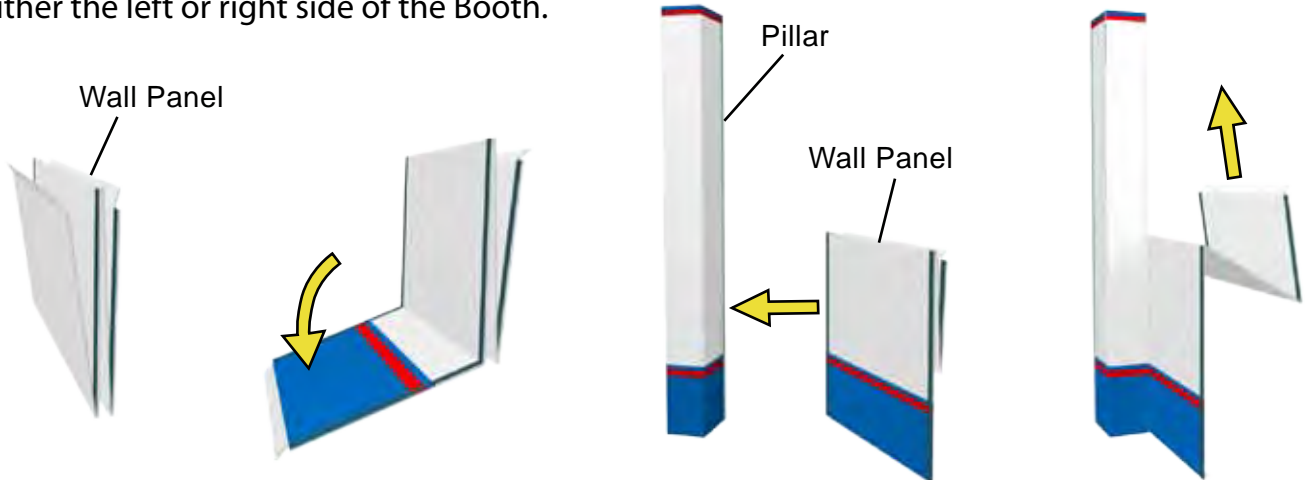

B) Unfold the top half of the Wall Panel and attach it to the top half of the Pillar matching the Velcro strips along the edges. Rotate the Wall Panel into position. Attach the next Pillar to the Wall Panel so that it is flat against the front face of the Wall Panel. Rotate the Pillar into position.

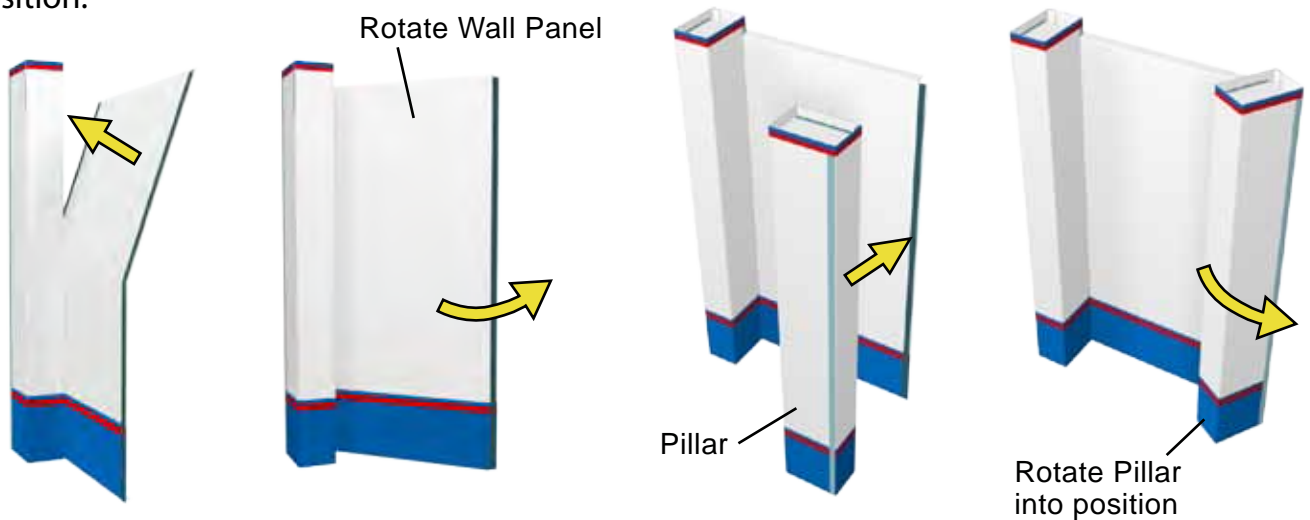

C) Repeat this process with the remaining Wall Panels and Pillars.



## Assembly Instructions: 10'x10' Multi Section Shelf Display

### Attach Short Wall Panel to Pillars.

A) Unfold the Short Wall Panel, hold upright, and attach to Pillar with Velcro. (Make sure that the bottoms of the Pillar and Short Wall Panel are **flat** against the floor when attaching and that the accent stripes are aligned with each other.)

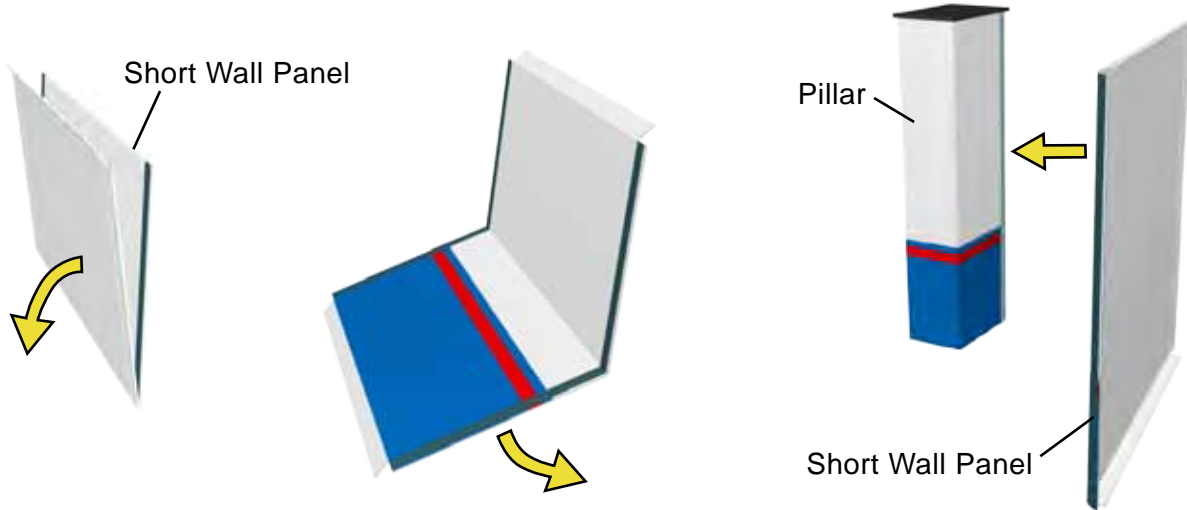

B) Rotate the Short Wall Panel into position. Attach the Short Pillar to the Short Wall Panel so that it is flat against the front face of the Short Wall Panel. Rotate the Pillar into position.

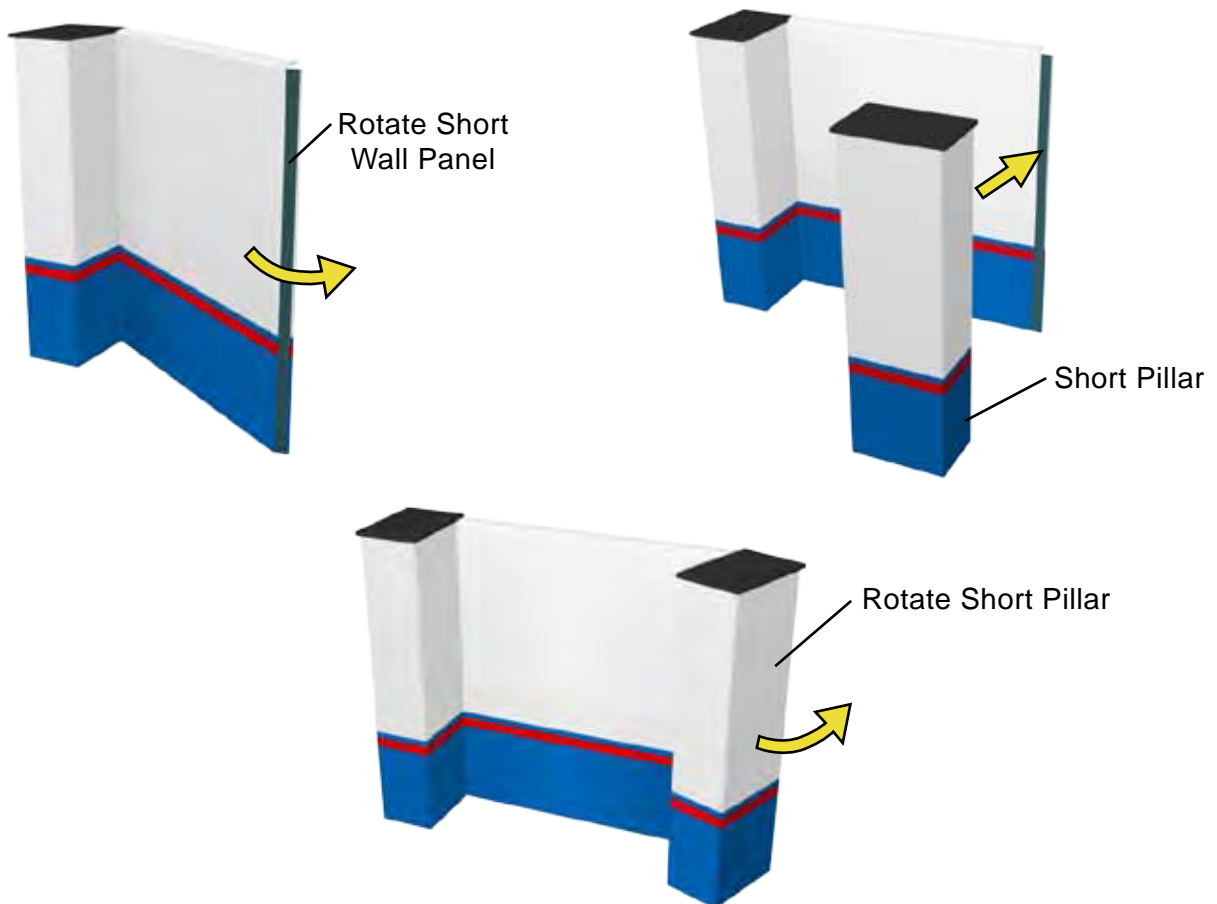

## Assembly Instructions: 10'x10' Multi Section Shelf Display

Install Storage Doors. (Attach Storage Doors to Pillars with Velcro.)

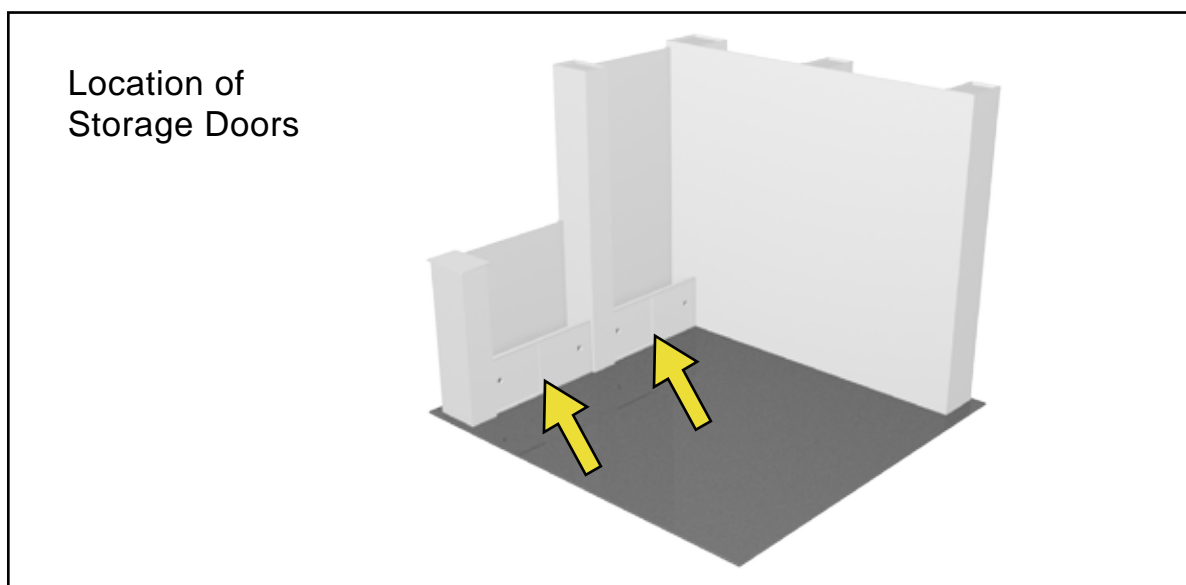

Install Shelf Support Bars.

A) Insert the shelf support bars into their designated openings in the Pillars with the **back bars** first, installing from the bottom upward. Then install the **front bars** from the bottom upward.

Make sure that the **Velcro on the bars is facing up** to attach the shelves and that the Velcro for the fluorescent lights is properly orientated along the backside of the front support bar.



(See the following pages for Support Bar Details)



# Assembly Instructions: 10'x10' Multi Section Shelf Display

## Shelf Support Bar Detail:

Locations of the Shelf/Fluorescent Light Support Bars are shown below.

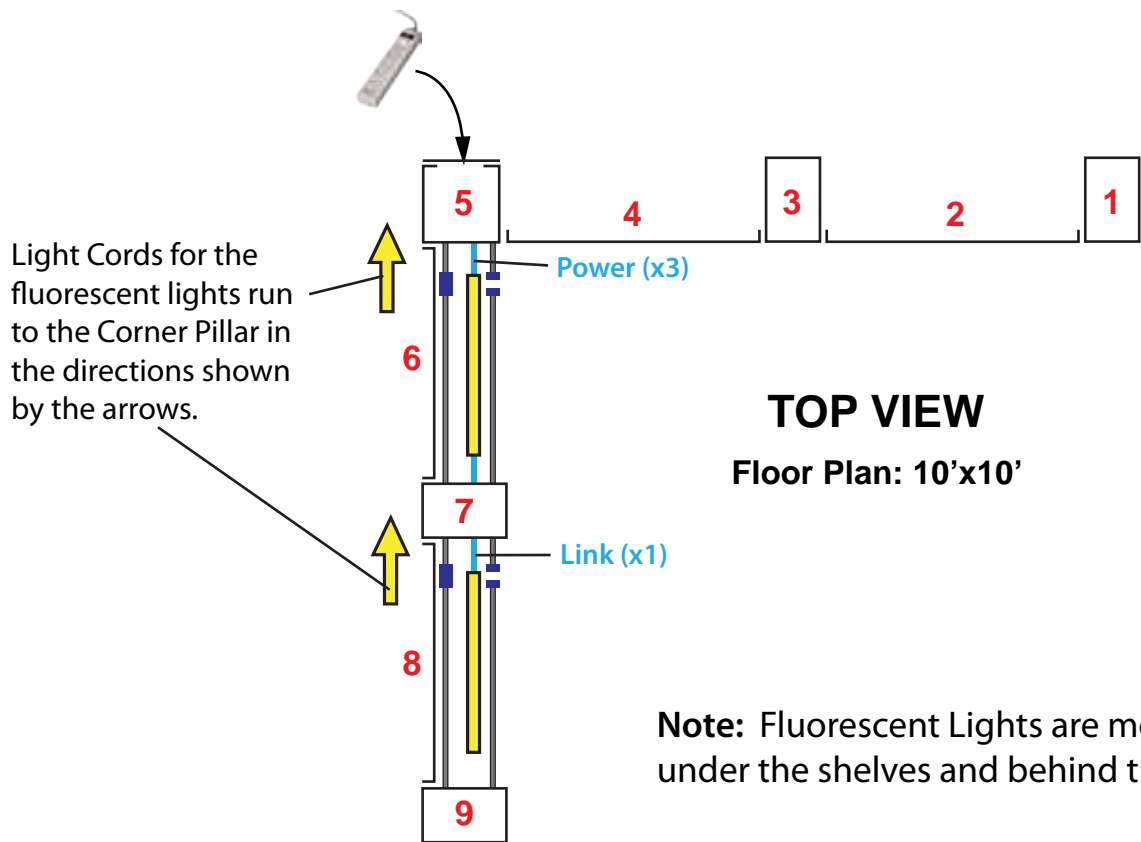

### LEGEND

	Support Bar (front)
	Support Bar (back)
	Fluorescent Light
	Power Cord/Link Cable

Fluorescent Lamp Assembly Details

Step 1:

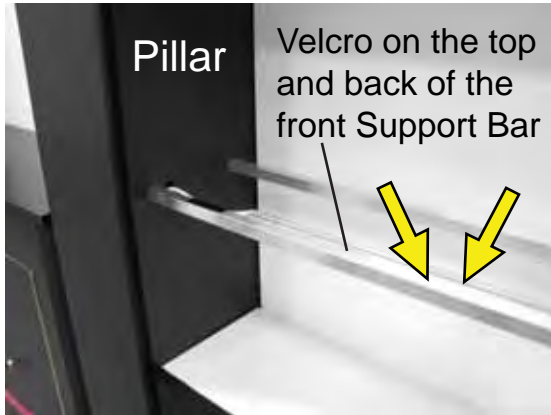

Start assembling the Fluorescent Lamps at the Pillars where the power will be connected. (Orient the Shelf Support Bars so that the Velcro is on top for the shelves and Velcro is in back of the front Bar for the Fluorescent Light.)

Step 2:

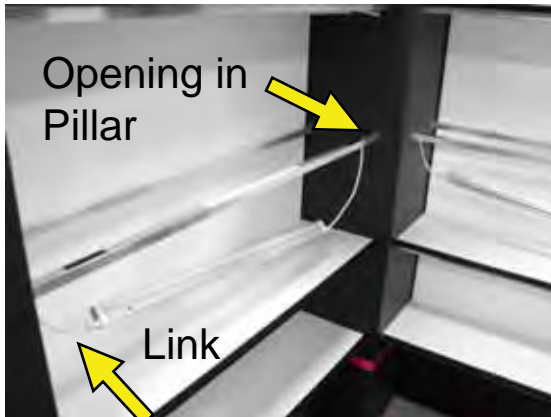

Attach Fluorescent Lights in series with the Link Cables threaded through the opening in the Pillar.



Link Cable.

Step 3:

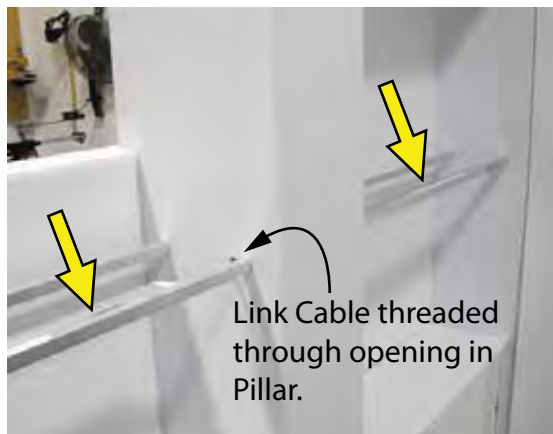

Attach the Fluorescent Lights to the back of the front Shelf Support Bars with Velcro.

## Assembly Instructions: 10'x10' Multi Section Shelf Display

### Fluorescent Lamp Assembly Details

**Step 4:**



Install a Support Bar behind the Sign so that the Velcro is facing to the back and attach a Fluorescent Light.

**Step 5:**

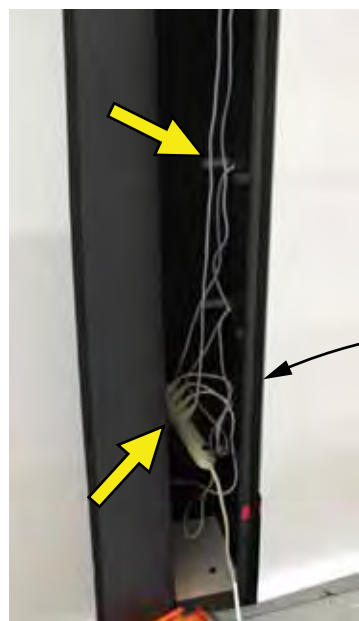

Connect the power for the Fluorescent Lights into the power strip located inside the the Corner Pillar.

(Light cords connected in series and plugged into the power strip inside the Corner Pillar.)

**Step 6:**



Attach Shelves to the top of the Shelf Support Bars with Velcro.

## Assembly Instructions: 10'x10' Multi Section Shelf Display

Attach the Large Poster to the middle Wall Panels and Center Pillar with Velcro.

A) Attach the three large sections of the large poster to the backwall panels and pillar starting from the right and working left. Attach the sections with Velcro so that there is approximately 1/4" overlap to match the text and graphic design.

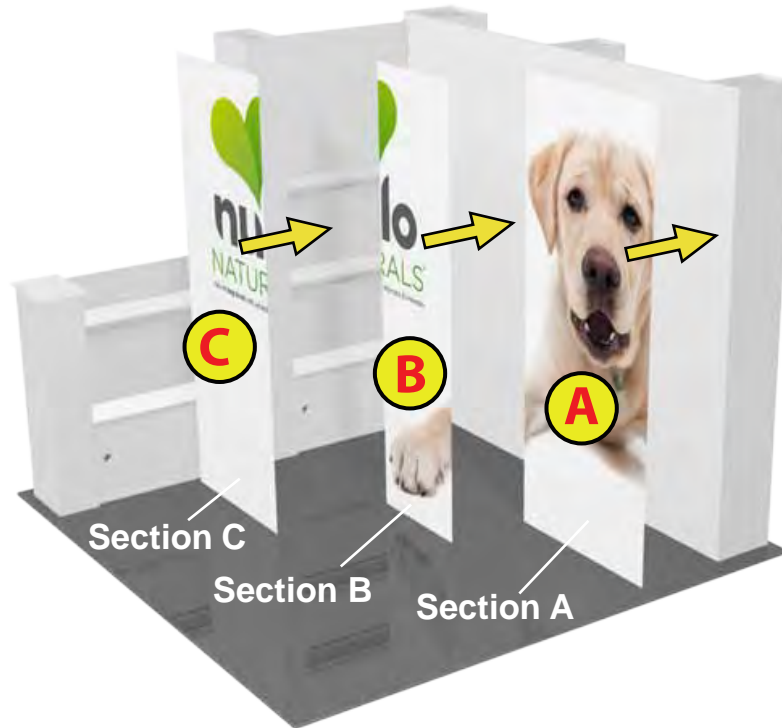

B) Attach the right side section of the poster to the outside of the end pillar.



View showing large poster installed along backwall.

## Assembly Instructions: 10'x10' Multi Section Shelf Display

Attach Pillar Posters to front Pillars with Velcro.



View showing posters attached to short pillar.

## Assembly Instructions: 10'x10' Multi Section Shelf Display

Attach the Sign to the inside of the Pillars with Velcro.



Attach the Stem Lights to the top of the Pillars.

A) Place a wooden Light Support Stick on top of the proper Pillars as shown. (Use a ladder or step stool to access the top of the Pillar.) Secure the Stick to the back of the Pillar with a Binder Clip.

B) Attach the Stem Light to the front end of the Pillar and Support Stick by adjusting the thumbscrew on the back of the Stem Light. (**DO NOT** overtighten the thumbscrew. Overtightening the adjustment thumbscrew may damage the Pillar.)

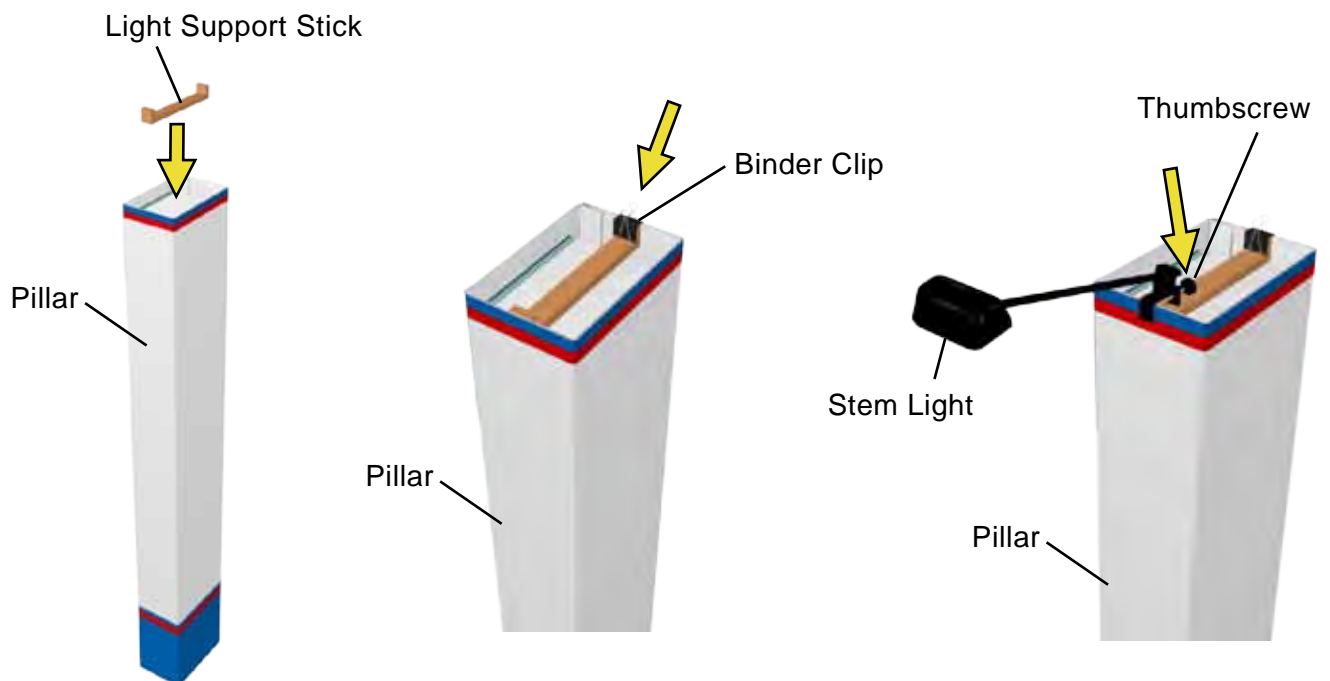

# Assembly Instructions: 10'x10' Multi Section Shelf Display

## Counter Assembly:

A) Connect the Counter Panels together with the 90° Channels and Velcro.

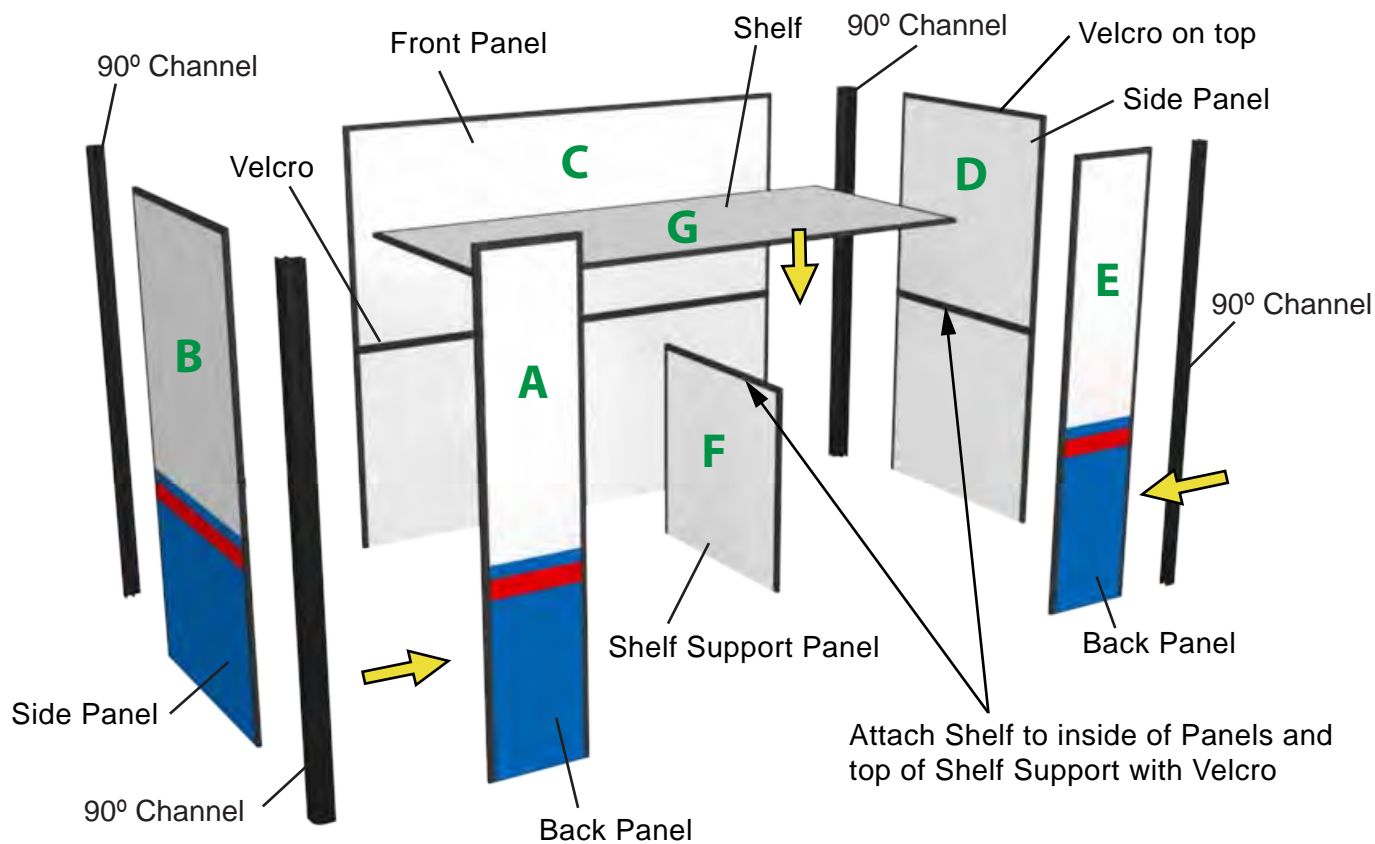

B) Place the Support Bar on top of the Back Panels and attach the Counter Top to the tops of the Panels and Support Bar with Velcro.

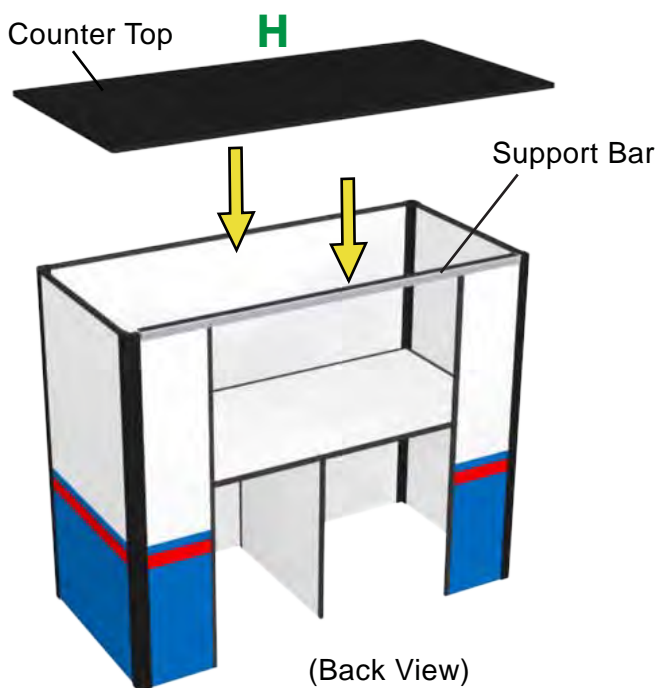

Attach Posters to front and side of the Counter with Velcro.

