

Set Up Instructions

EL-HB-05

Step 1: Assemble the different frame sections by pushing and pulling pipes together.

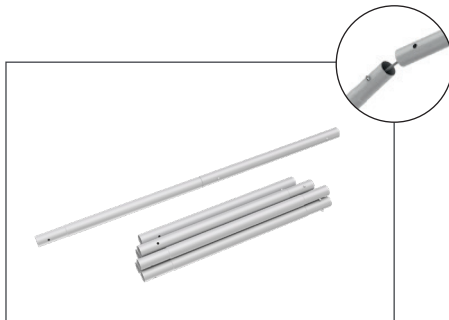

Step 2: Connect all corner sections to longer sections of the frame by matching shape symbols on pipes.

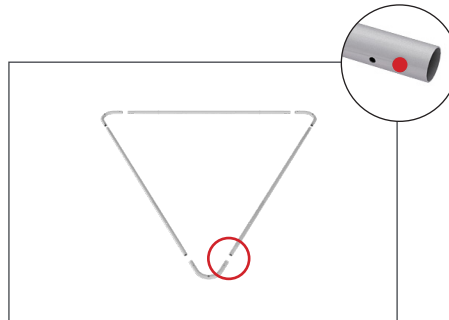

Step 3: Align two frames together making sure holes face each other.

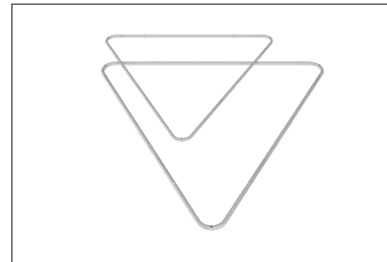

Step 4: Push all support poles into one frame. **Step 5:** Locate all the poles pushed into black grommets and place one end of a cable eyelet over those poles.

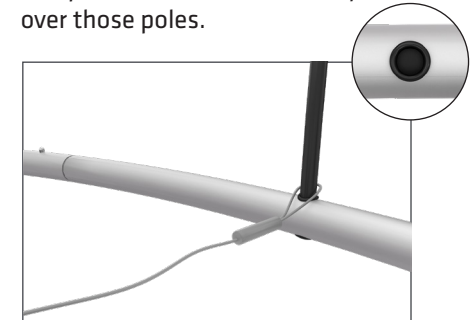

Step 6: Align top frame to bottom frame and push support poles into the frame. With some force connect the support poles in the middle to complete.

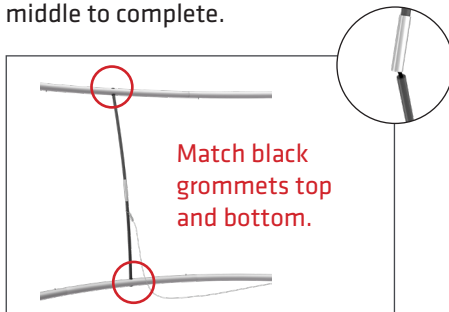

Step 7: Unzip print and place one frame inside. Position holes on frame to align with eyelets in graphic. Thread cable through eyelet. Repeat for all eyelets.

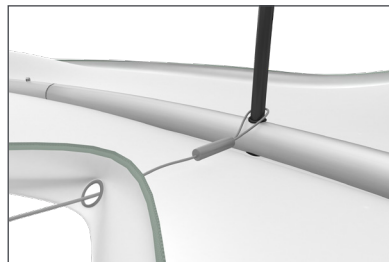

Step 9: Complete.

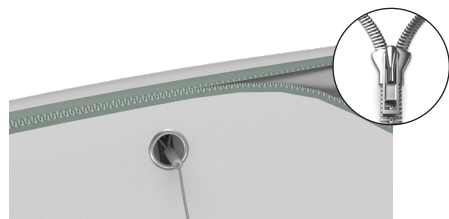
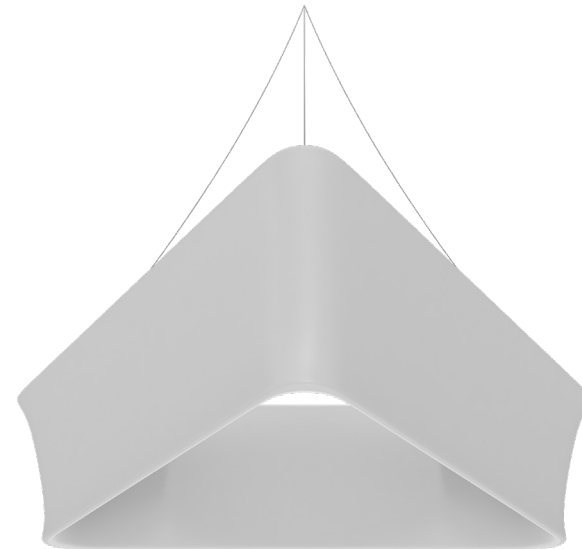

Step 8: Zip graphic closed around top of frame. Pull all cables out until inside loop is flush with eyelets. Attach all cables together at a single point for hanging.