

FabLite Designer Series Kit FL-DS-2020-03

FL-DS-2020-03

FabLite Designer Series provides an unparalleled dynamic that elevates and accentuates a message and brand, but also maximizes the return on trade show investment. A fusion of FORM, FABRIC and FUNCTION, these kits combine organic and architectural shapes with state-of-the-art zipper pillowcase dye-sublimated fabric graphics to create unique, dynamic and functional island space.

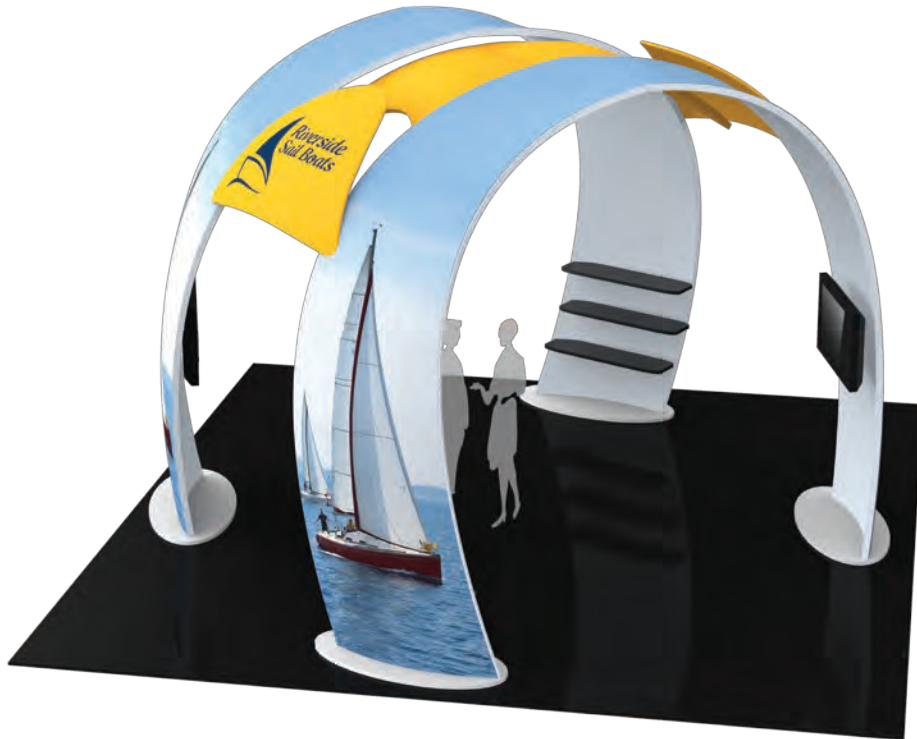

features and benefits:

- 50mm aluminum tube frame
- Single-sided SEG dye-sublimated push-fit fabric graphics
- Shelves available in four thermoform finishes, shown below
- Kit includes frame, dye-sublimated graphics, two medium monitor mounts, and six laminated shelves.
- Lifetime hardware warranty against manufacturer defects
- Kit includes: (2) medium monitor mounts, can hold 32-55" monitor/ max weight 40 lbs

dimensions:

Hardware

Assembled unit:

195.6" w x 150.74" h x 177.56" d
4969mm(w) x 3829mm(h) x 4510mm(d)

Approximate weight with cases:

1402 lbs /635.9 kgs

Shipping

Packing case(s):
1 WOODCRATE-H

Shipping Dimensions:

96" l x 48" w x 48" h
2438mm(l) x 1219mm(w) x 1219mm(h)

Approximate total shipping weight
(includes cases & graphics):

1487 lbs /674.3kgs

additional information:

Graphic material:
dye-sublimation zipper pillowcase fabric

*Monitors and flooring not included

Shelf Dimensions: 47" w x 1.18 "h x 11.75" d
Shelf Max Weight Capacity: 10lbs

Wood Finish Options



silver

black

mahogany

natural

Included In Your Kit

Tools, Components, & Connectors



ALLEN KEY SET x2



ES30 x28



ES50 x56



EXT-M-MB x2

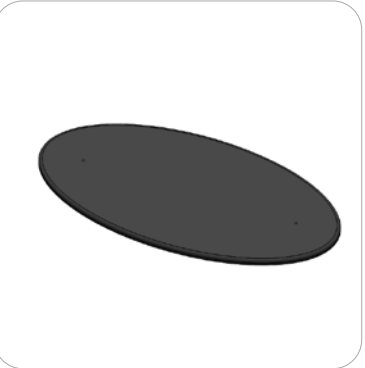

BASE-CFAB-K-07-1 x4



SHLF-CFAB-K-07-1 x6



LN114-SCRW x32

Graphics

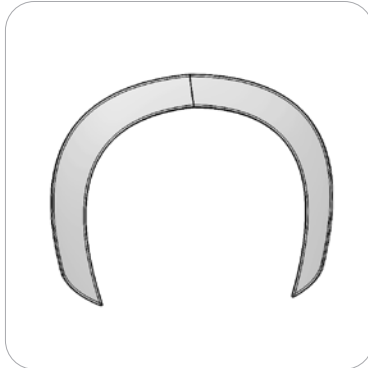

CFAB-K-07-A-G x2

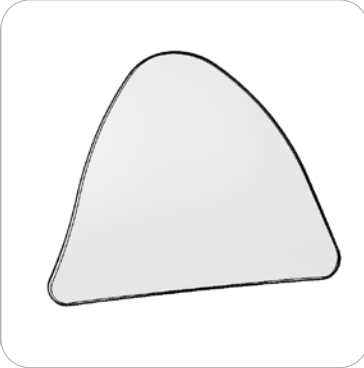

CFAB-K-07-B-G x2



CFAB-K-07-C-G x1

Included In Your Kit



CFAB-K-07-T1 x2



CFAB-K-07-T2 x2



CFAB-K-07-T3 x2



CFAB-K-07-T4 x2



CFAB-K-07-T5 x2

Tubes



CFAB-K-07-T6 x2



CFAB-K-07-T7 x2



CFAB-K-07-T8 x2



CFAB-K-07-T9 x2



CFAB-K-07-T10 x2



CFAB-K-07-T11 x2



CFAB-K-07-T12 x2



CFAB-K-07-T13 x2



CFAB-K-07-T14 x2



CFAB-K-07-T15 x2

Included In Your Kit



CFAB-K-07-T16 x2



CFAB-K-07-T17 x2



CFAB-K-07-T18 x2

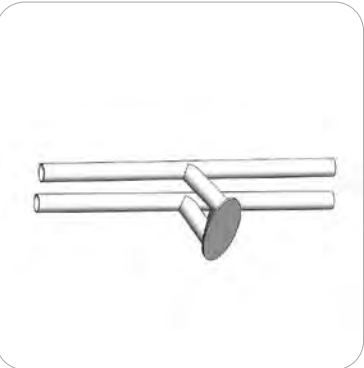

CFAB-K-07-T19 x2



CFAB-K-07-T20 x2

Tubes



CFAB-K-07-T21 x2



CFAB-K-07-T22 x2



CFAB-K-07-T23 x2



CFAB-K-07-T24 x2



CFAB-K-07-T25 x2



CFAB-K-07-T26 x2



CFAB-K-07-T27 x2



CFAB-K-07-T28 x2

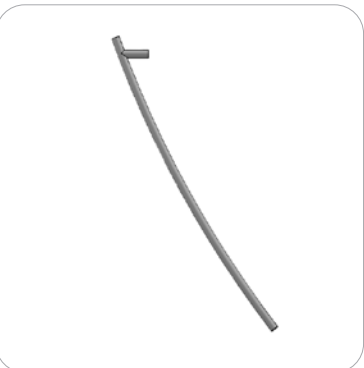

CFAB-K-07-T29 x2



CFAB-K-07-T30 x2

Included In Your Kit



CFAB-K-07-T31 x2



CFAB-K-07-T32 x2



CFAB-K-07-T33 x1



CFAB-K-07-T34 x1



CFAB-K-07-T35 x1

Tubes



CFAB-K-07-T36 x1



CFAB-K-07-T37 x1



CFAB-K-07-T38 x1



CFAB-K-07-T39 x1



CFAB-K-07-T40 x1



CFAB-K-07-T41 x1

Exploded View

FL-DS-2020-03

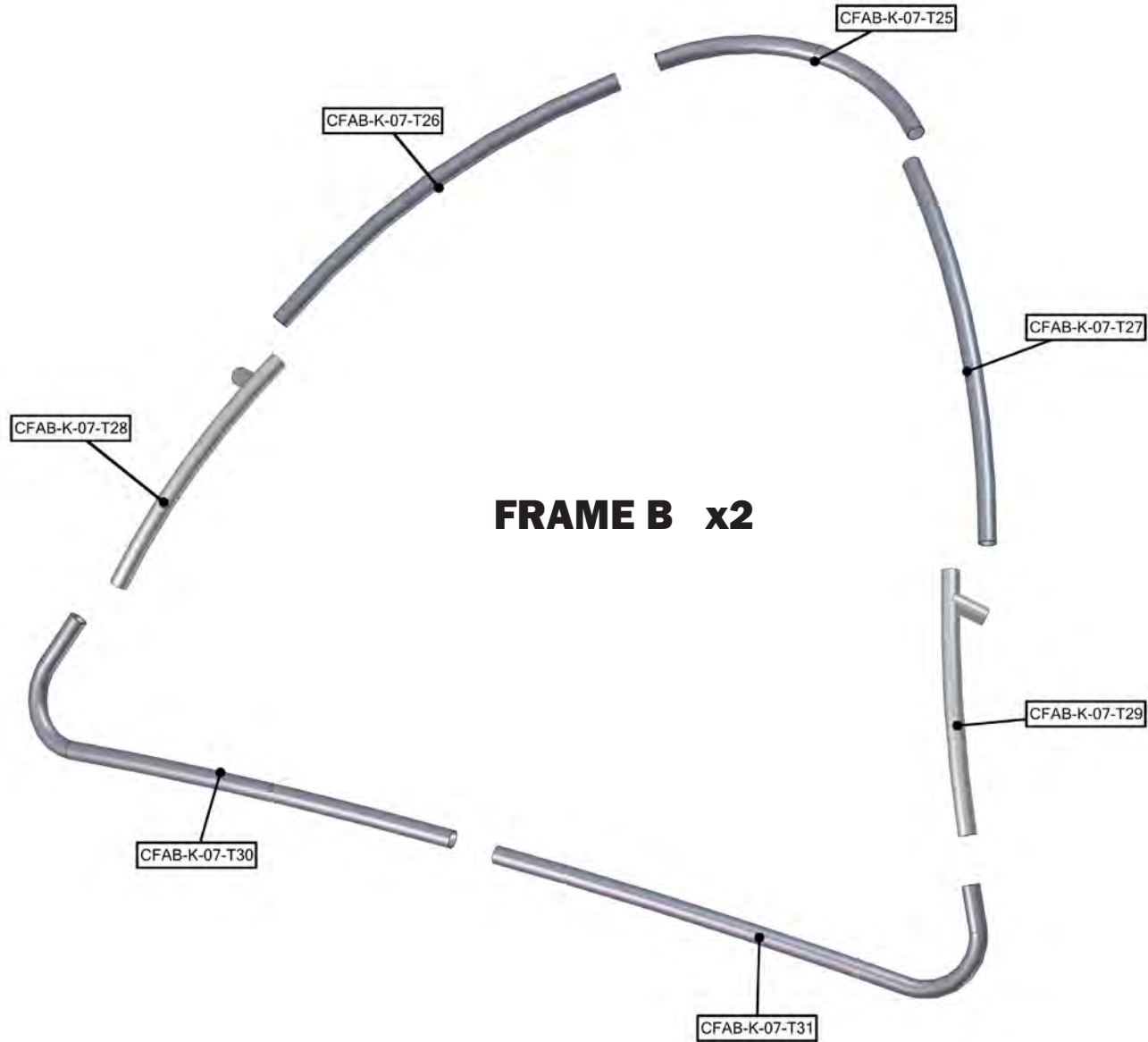

Exploded View

FL-DS-2020-03

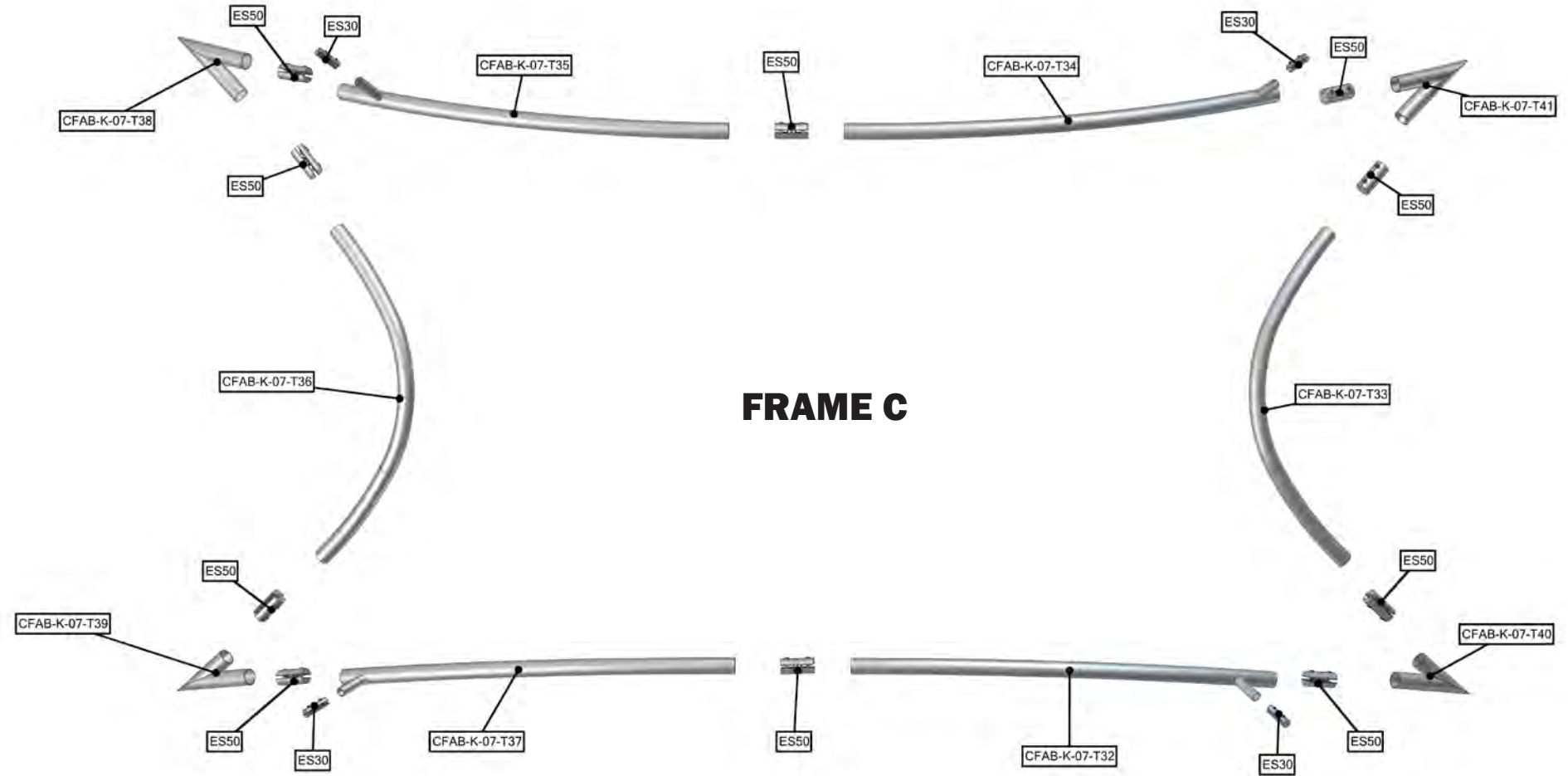

Labeling Diagram

FL-DS-2020-03



OVERVIEW

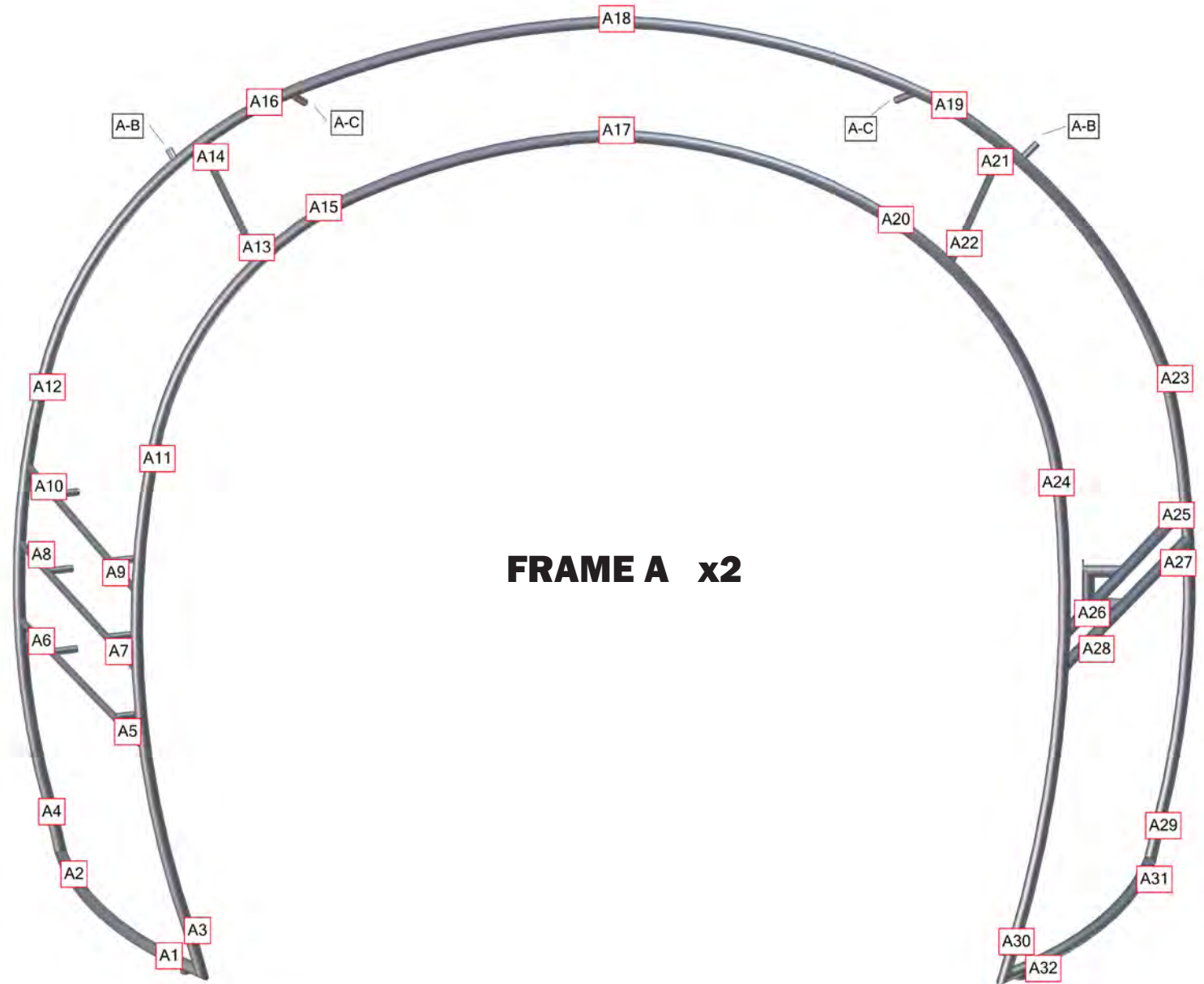

FRAME A x2

Labeling Diagram

FL-DS-2020-03



OVERVIEW

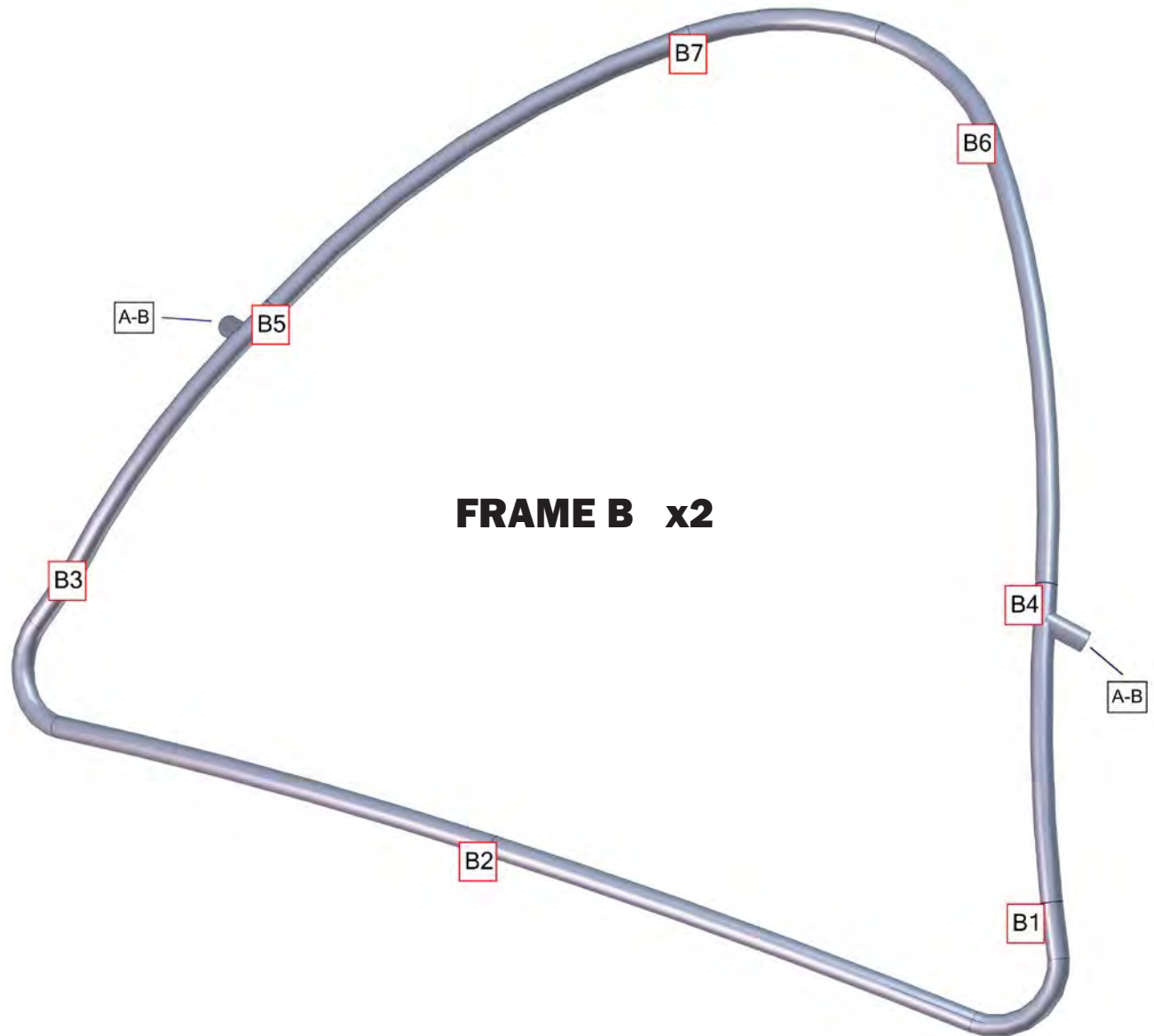

FRAME B x2

Labeling Diagram

FL-DS-2020-03



OVERVIEW

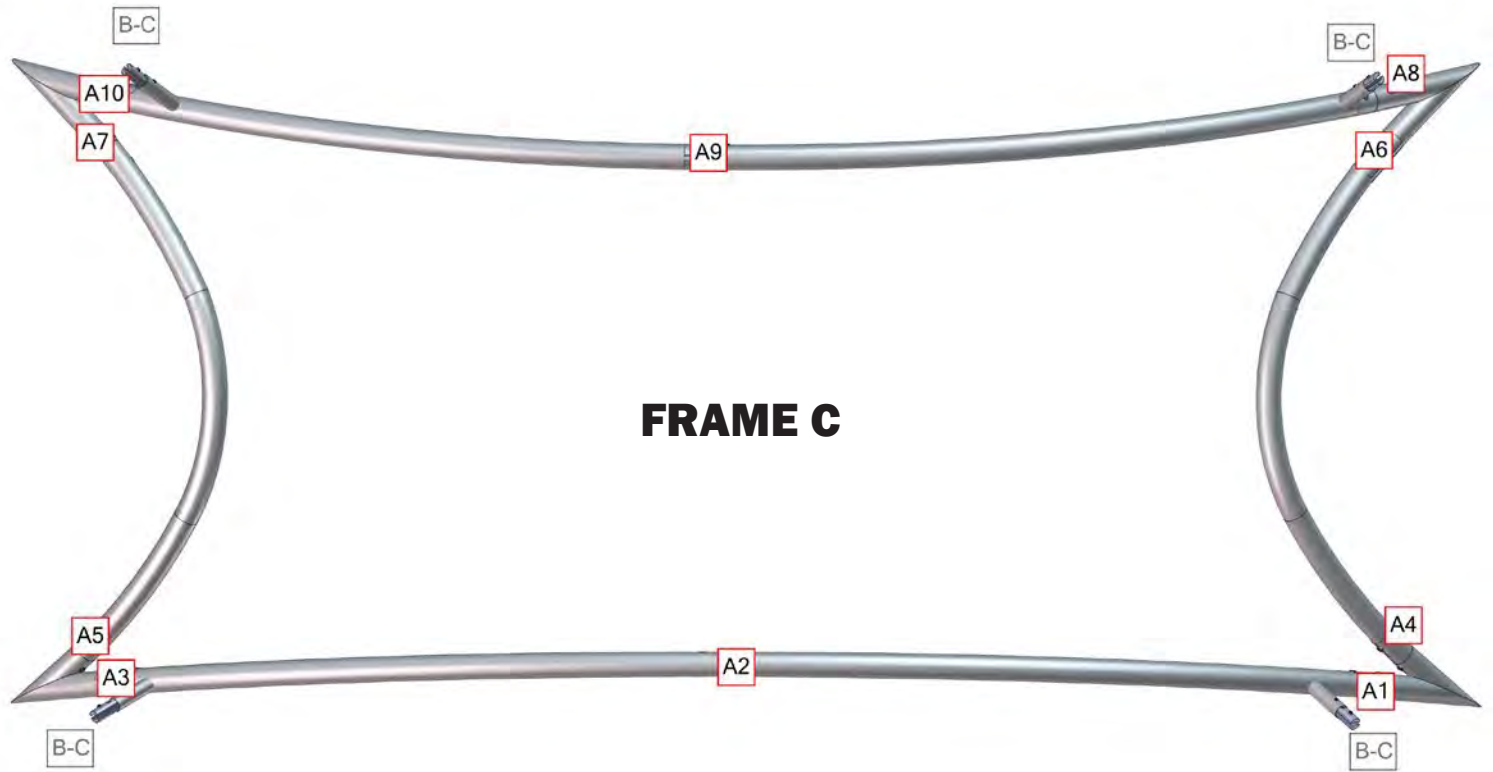

FRAME C

Connection Methods

FabLite structures use a number of different yet simple connection methods. Your kit will include one or more of the connection methods shown below. Steps within the Kit Assembly will reference a specific method for each connection point.

Connection Method 1: ES30 / ES50 / ES75

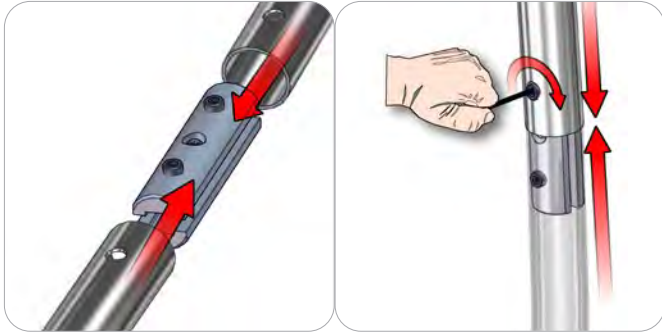

Compress the unlocked connector and slide one tube onto each end. Lock both screws carefully using your allen key tool. Be sure to lock securely, but do not overtighten.

Connection Method 2: Snap Buttons & Swage

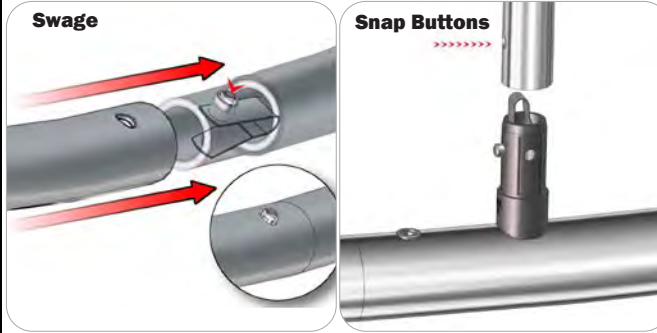

Locate the snap button on the connector or swage tube. Locate the hole on the corresponding tube. Press the snap button with your thumb and slide the tube and connector together so that the snap button snaps fully into the lock hole. To disassemble, press the snap button and pull apart.

Connection Method 3: ES30-90B / ES30-I / ES30-C

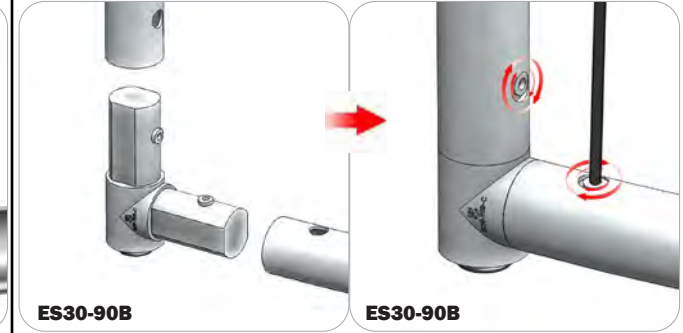

Compress one unlocked end of the connector and slide it through one tube end. Compress the other end of the connector and slide the second tube on. Lock both screws carefully using your allen key tool. Be sure to lock securely, but do not overtighten.

Connection Method 4: Tube Clamps



Be sure to fully assemble all frames before using clamps. With the clamp unlocked, place one tube of the first frame into the mouth of the clamp. Place the second tube (if applicable) into the second mouth of the clamp. With both frame's tubes in the clamp, be sure to lock securely, but do not overtighten.

Kit Assembly

Step by Step

Step 1.

Gather the components necessary for assembling (2) Frame A. Assemble in the order the Labeling Diagram instructs.

Refer to Connection Method 1 for additional information.

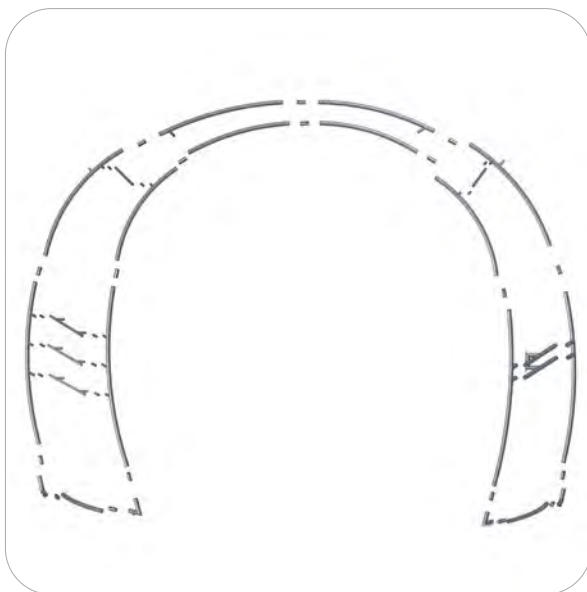

Step 2.

With frame laying flat on the floor, locate your pillowcase graphic. With the pillowcase unzipped, encase the frames and zip along the side.

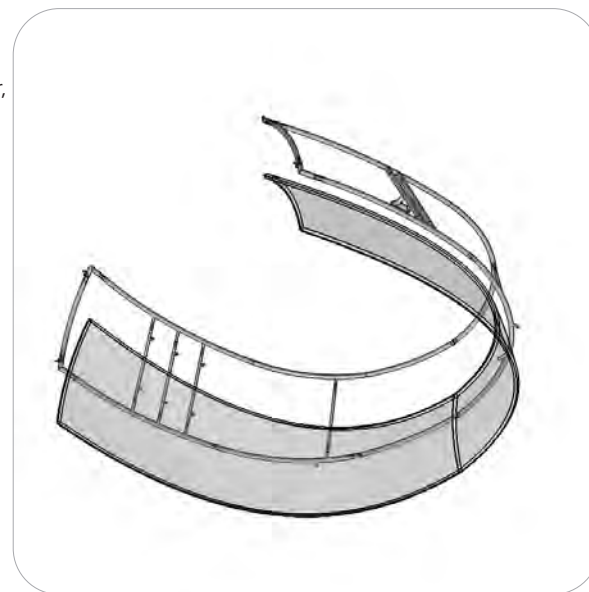

Step 3.

Gather the components necessary for assembling (2) Frame B. Assemble in the order the Labeling Diagram instructs.

Refer to Connection Methods 1 for additional information.

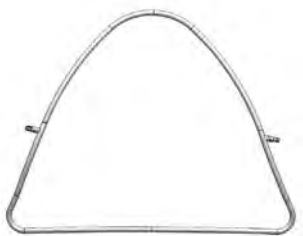

Step 4.

With frame laying flat on the floor, locate your pillowcase graphic. With the pillowcase unzipped, encase the frames and zip along the side.



Kit Assembly

Step by Step

Step 5.

Gather the components necessary for assembling Frame C. Assemble in the order the Labeling Diagram instructs.

Refer to Connection Methods 1 and 2 for additional information.

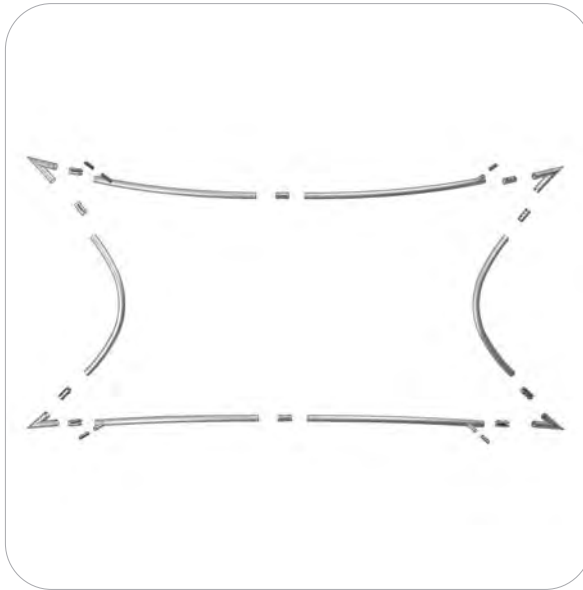
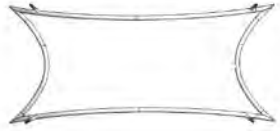

Step 6.

With frame laying flat on the floor, locate your pillowcase graphic. With the pillowcase unzipped, encase the frames and zip along the side.



Step 7.

Locate your bases. With the frames still laying on the ground, attach your bases to each end of Frame A using the provided LN114 Screws.

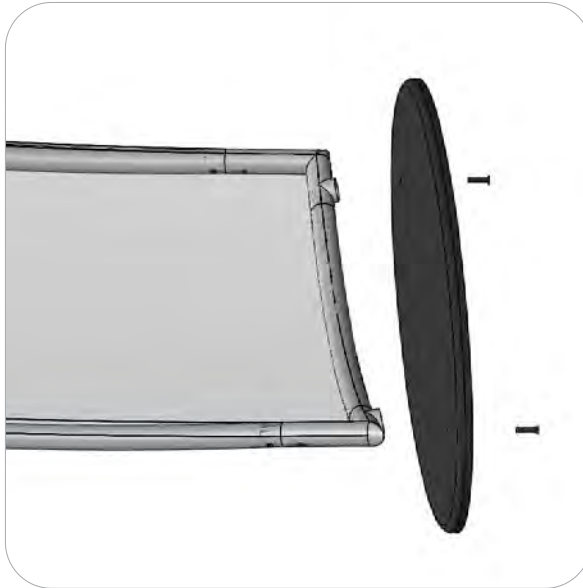
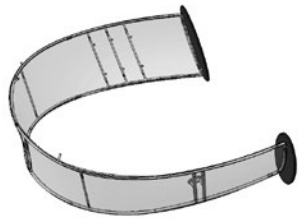

Step 8.

Locate your pillowcased Frame B assemblies. Stand your Frame A assemblies and connect them using the Frame B assemblies.

Refer to Connection Method 2 for additional information.



Kit Assembly

Step by Step

Step 9.

Locate your pillowcased Frame C assembly. Attach Frame C to the underside of your Frame A assemblies.

Refer to Connection Method 1 for additional information.



Step 10.

Locate your (6) shelves. Use the provided thumbscrews to attach the shelf to the welded plates of the protruding tubes.

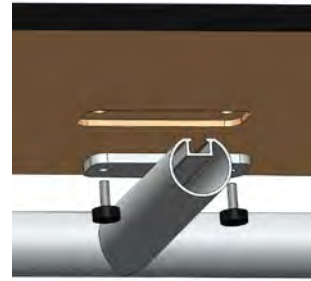

Step 11.

Locate your monitor brackets. Thread the provided square bolts through the back of the steel plates. Push the monitor bracket onto the bolts utilizing the holes in the bracket. Use (2) washers and (2) wingnuts to lock the monitor bracket to the plate.



Setup Complete

