

# FabLite BrightLine Panel W

FL-BL-PW

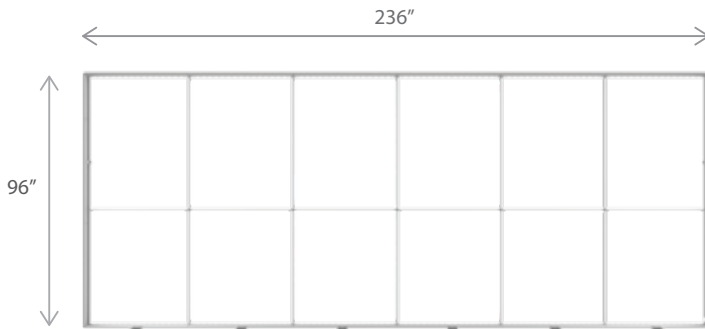
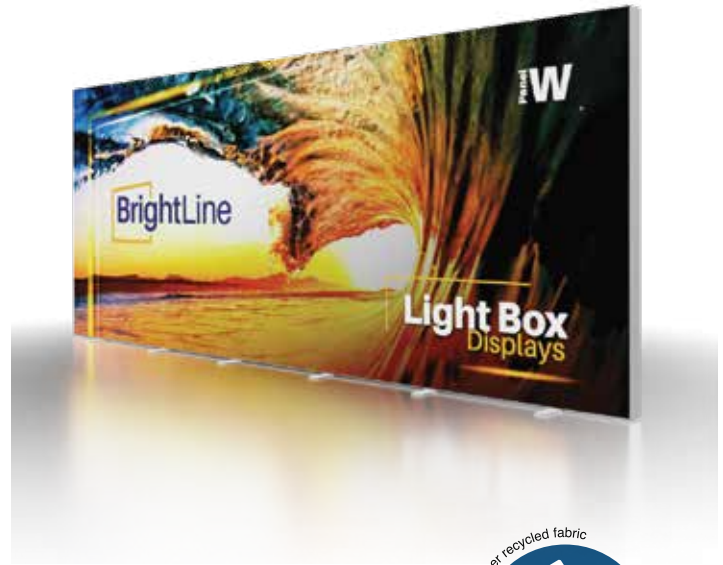

| PRODUCT DESCRIPTION   |  |
|---|--|
| <p>FabLite BrightLine smart light box displays feature swift tool-free installation, durable light-weight frames, embedded LEDs, and exclusive One Planet recycled fabrics with impressive vivid graphics, all conveniently organized in a heavy-duty shipping case. Panel W seamlessly fills the popular 20ft exhibit, providing an impressive, illuminated backdrop for elevated branding.</p> <p>Mix-and-match with other FabLite BrightLine panels to create unique branded environments. TV mounts, shelving units and counters complete an enhanced experience to really make brands stand out.</p> |  |

| DIMENSIONS     |  |
|----------------|--|
| Assembled Unit | 236" w x 96" h x 4" d                    |
| Packed Case    | 46.5" w x 15" h x 12" d, 73 lbs (Qty. 2) |
| Shipping Box   | 47" w x 16" h x 13" d, 75 lbs (Qty. 2)   |
| Graphic Size   | 236" w x 96" h                           |

| LED LIGHT SPECIFICATIONS |              |
|--------------------------|--------------|
| Power Requirements       | 384 W        |
| CCT (Color Temp)         | 6000 K       |
| Voltage Input            | 110 / 220V   |
| Voltage Output           | 24V 11A 264W |
| Transformers Included    | 2            |

| KEY FEATURES   |   |
|--|---|
| <ul style="list-style-type: none"> <li>• Easy tool free assembly</li> <li>• Lightweight portable construction</li> <li>• Magnetic power links</li> <li>• LED lights encapsulated in frame</li> </ul> | <ul style="list-style-type: none"> <li>• Heavy duty shipping case, molded foam inserts</li> <li>• Single- or double-sided</li> <li>• Vibrant graphics on recycled fabric</li> </ul> |

| DISPLAY CONSTRUCTION                       |
|--|
| Aluminum frame with aluminum support poles |

| GRAPHIC MATERIAL   |                                |
|--|--------------------------------|
| Graphic Print :<br>Dye sublimated on One Planet, 100% recycled, backlit fabric | Bottles recycled<br><b>164</b> |
| Blocker :<br>One Planet light block recycled fabric                            | Bottles recycled<br><b>66</b>  |

| GRAPHIC FINISHING   |
|---------------------|
| Silicone sewn edges |

| WARRANTY   |
|--|
| Limited Warranty Periods   |
| <ul style="list-style-type: none"> <li>- Frame : Lifetime</li> <li>- Lights : 90 days</li> <li>- Graphics : 30 days</li> </ul> |

# FabLite BrightLine Panel W

FL-BL-PW

## PARTS

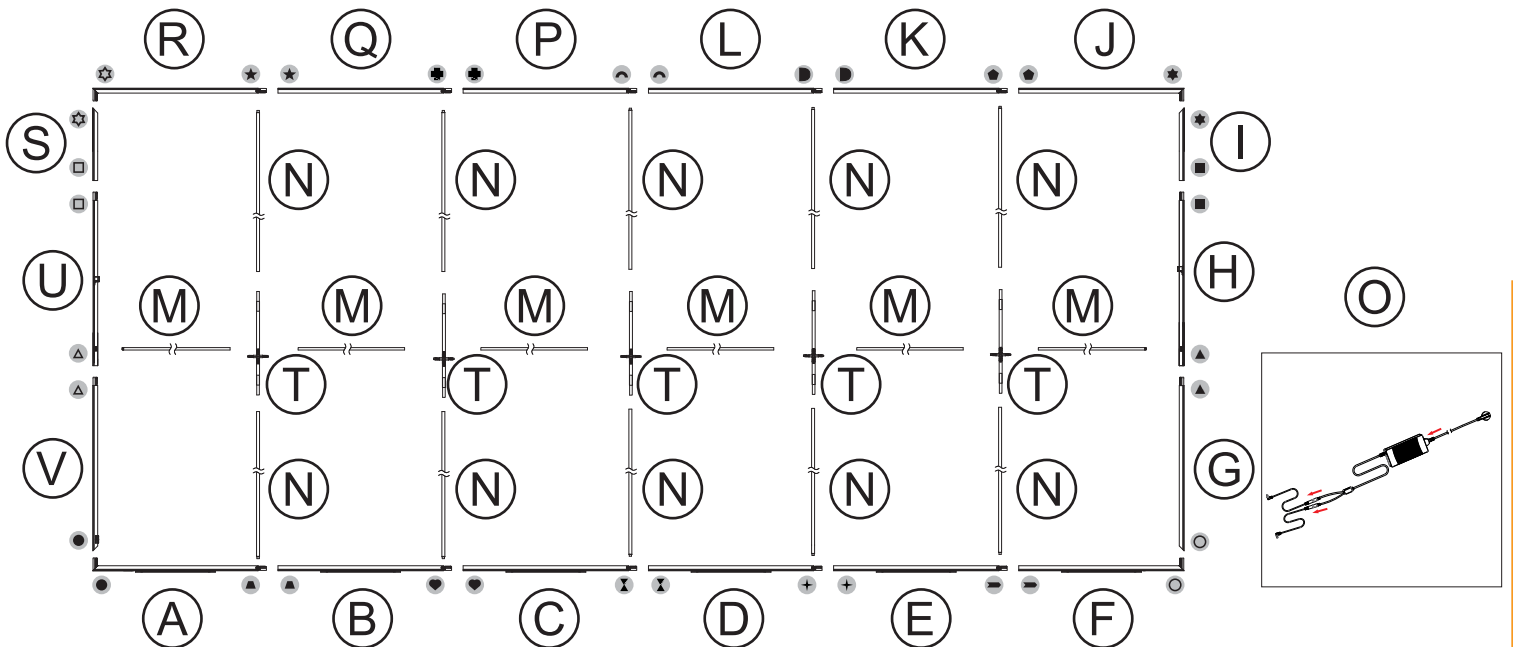
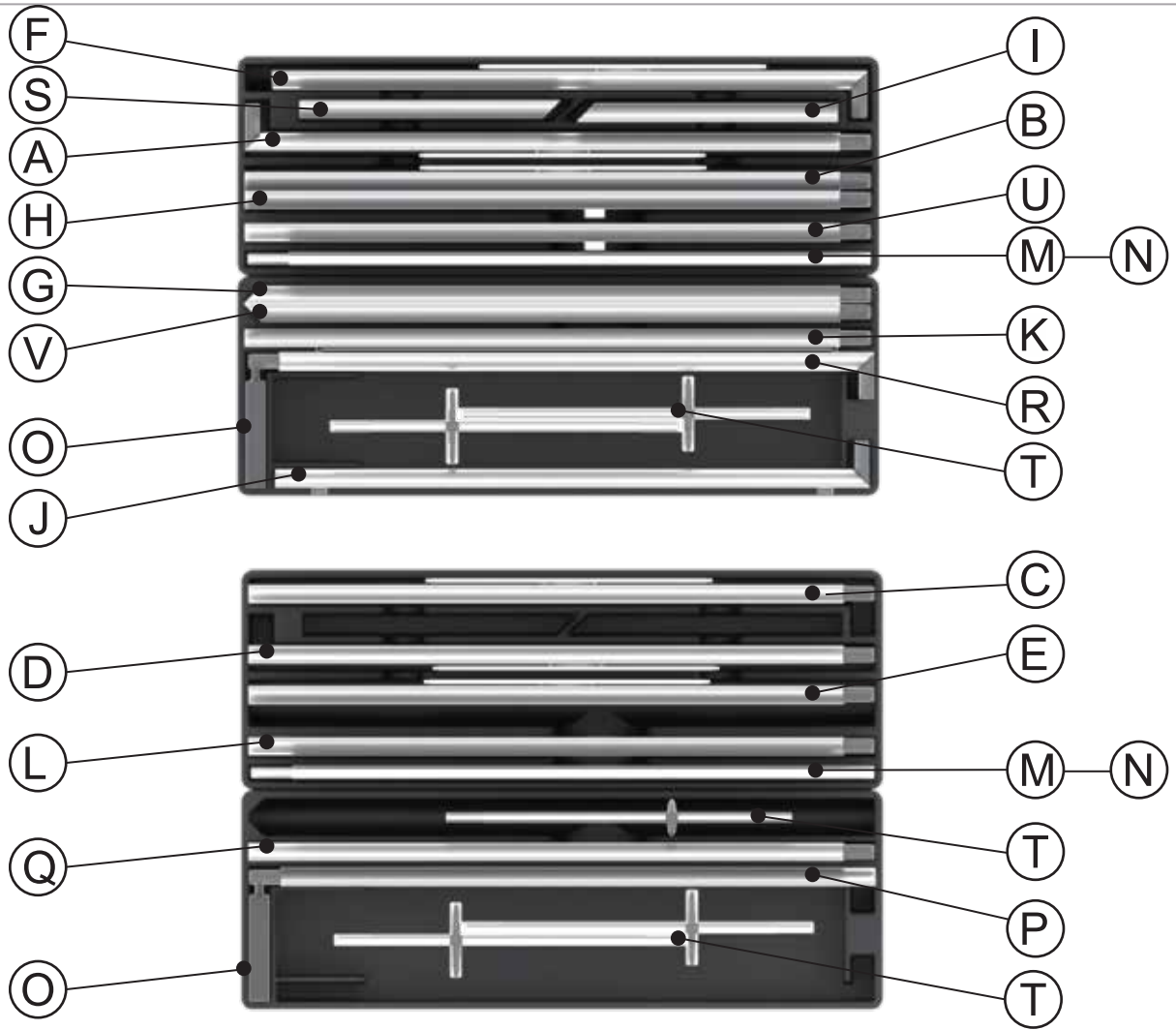

## ASSEMBLY

Assemble parts on the floor and stand-up unit when completed.

1

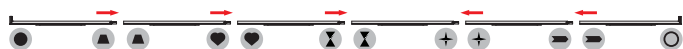
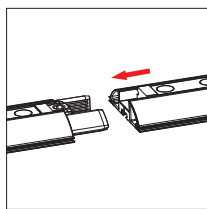

2

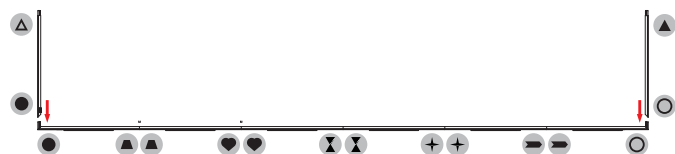
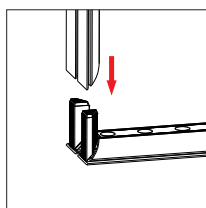

3

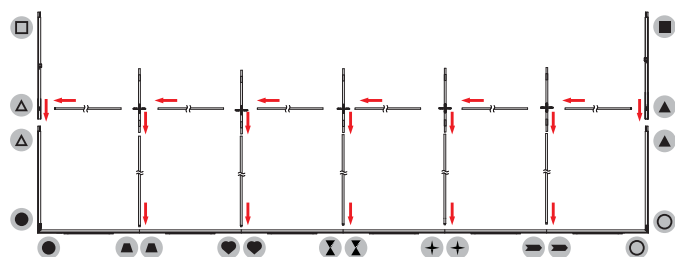
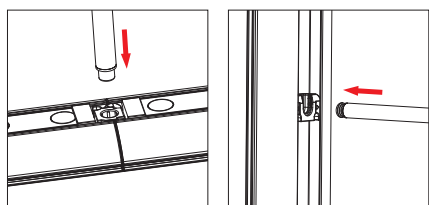

4

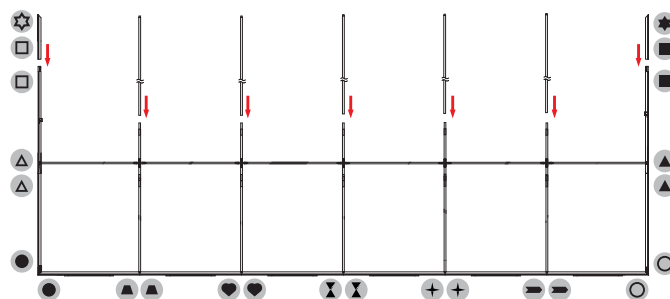
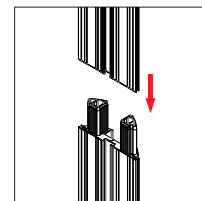

5

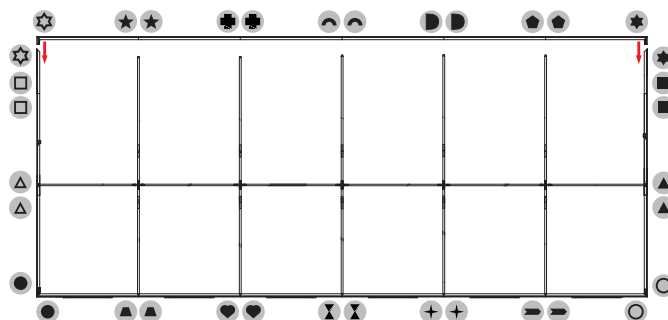
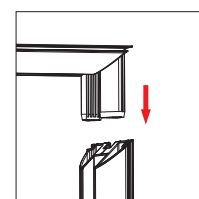

# FabLite BrightLine Panel W

FL-BL-PW

- 6 Push the silicone bead into each corner of the frame with your thumb.

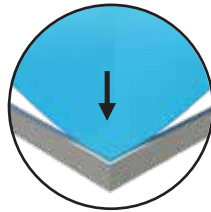
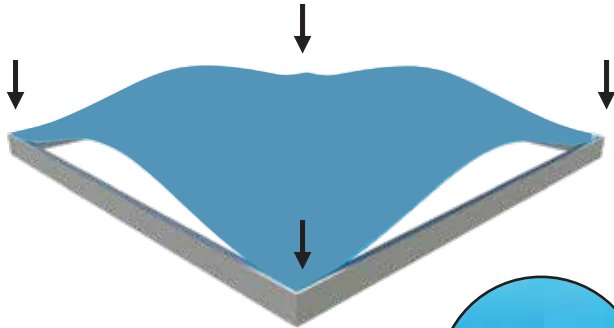

- Push the silicone bead into the middle of the run and work your way around the perimeter of the frame until all beading is pushed in properly

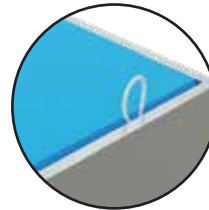
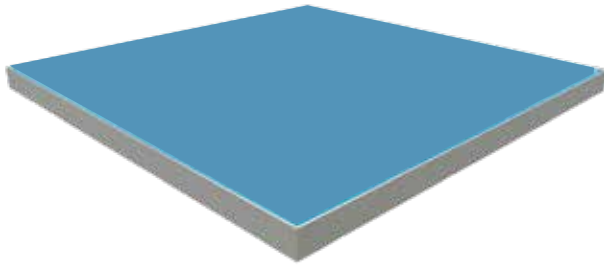
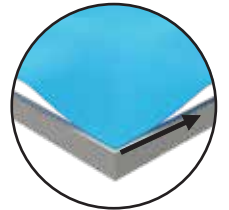
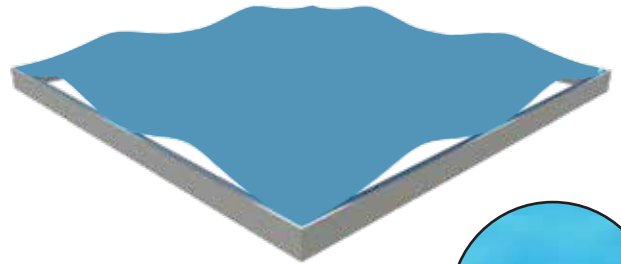

- To Remove Graphic**  
Use the pull tab located on the graphic and gently pull the graphic from the frame, going around the perimeter

- 7

