

# FabLite BrightLine Panel P

FL-BL-PP

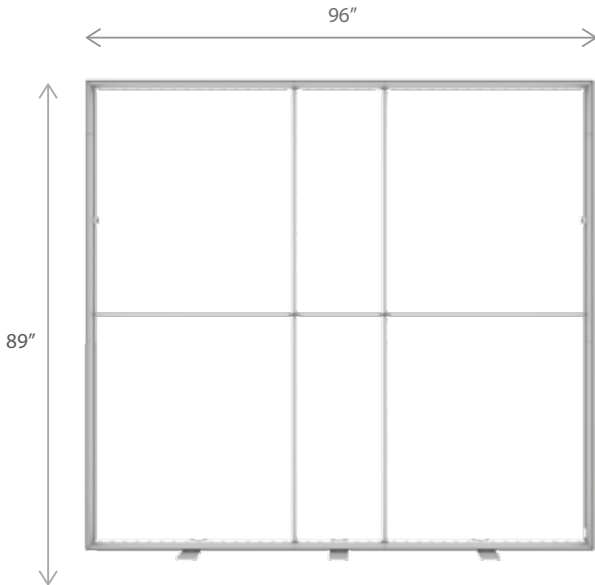

PRODUCT DESCRIPTION	
<p>FabLite BrightLine smart light box displays feature swift tool-free installation, durable light-weight frames, embedded LEDs, and exclusive One Planet recycled fabrics with impressive vivid graphics, all conveniently organized in a heavy-duty shipping case. Panel P engages with its radiant allure, with an 8ft size that is perfect for corporate presentations, networking events and retail activations.</p> <p>Mix-and-match with other FabLite BrightLine panels to create unique branded environments. TV mounts, shelving units and counters complete an enhanced experience to really make brands stand out.</p>	

KEY FEATURES	
<ul style="list-style-type: none"> <li>• Easy tool free assembly</li> <li>• Lightweight portable construction</li> <li>• Magnetic power links</li> <li>• LED lights encapsulated in frame</li> </ul>	<ul style="list-style-type: none"> <li>• Heavy duty shipping case, molded foam inserts</li> <li>• Single- or double-sided</li> <li>• Vibrant graphics on recycled fabric</li> </ul>

DISPLAY CONSTRUCTION
Aluminum frame with aluminum support poles

DIMENSIONS	
Assembled Unit	96"w x 89"h x 4"d
Packed Case	46.5"w x 15"h x 12"d, 65 lbs
Shipping Box	47"w x 16"h x 13"d, 67 lbs
Graphic Size	96"w x 89"h

GRAPHIC MATERIAL	
Graphic Print : Dye sublimated on One Planet, 100% recycled, backlit fabric	Bottles recycled <b>62</b>
Blocker : One Planet light block recycled fabric	Bottles recycled <b>25</b>

LED LIGHT SPECIFICATIONS	
Power Requirements	152 W
CCT (Color Temp)	6000 K
Voltage Input	110 / 220V
Voltage Output	24V 11A 264W
Transformers Included	1

GRAPHIC FINISHING
Silicone sewn edges

WARRANTY
Limited Warranty Periods
- Frame : Lifetime
- Lights : 90 days
- Graphics : 30 days

## PARTS

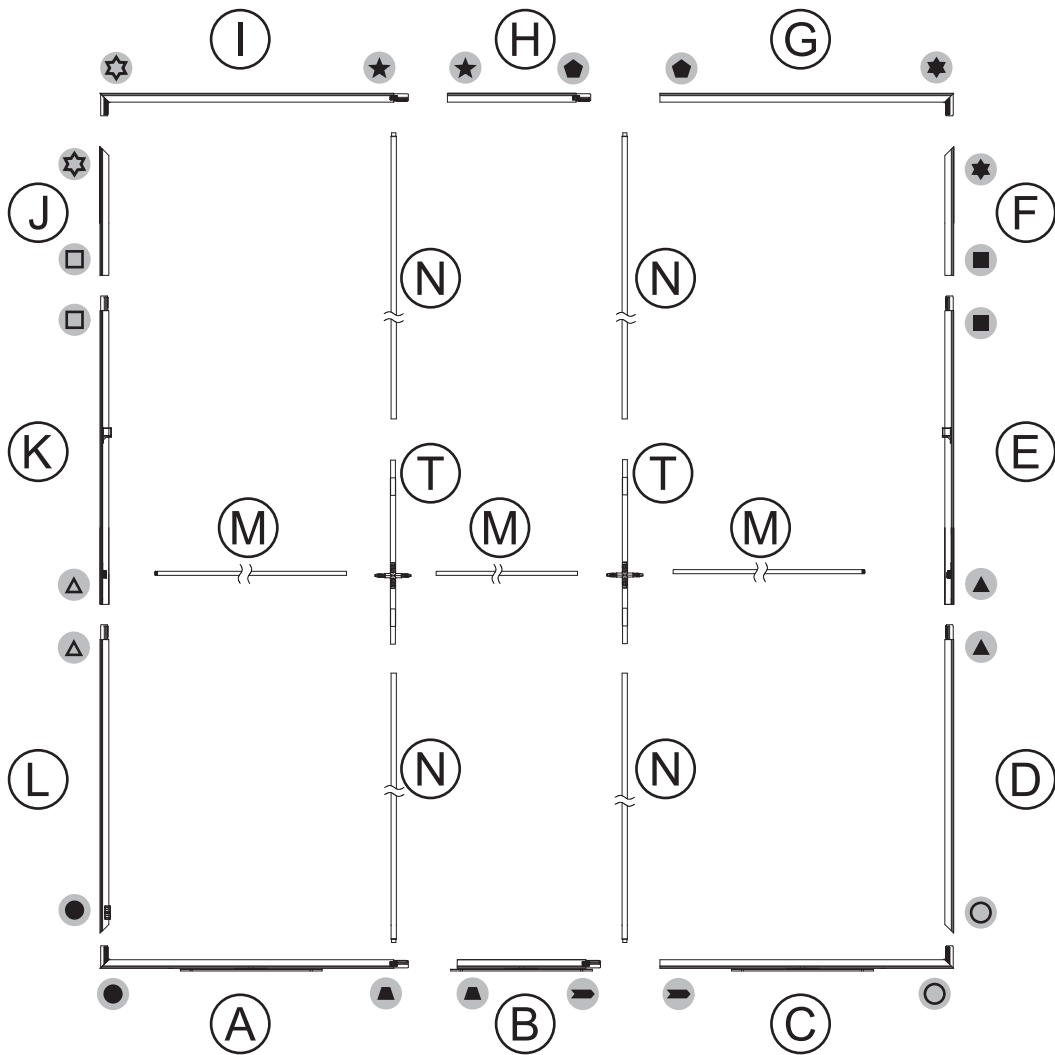

## ASSEMBLY

Assemble parts on the floor and stand-up unit when completed.

1

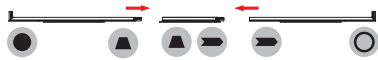
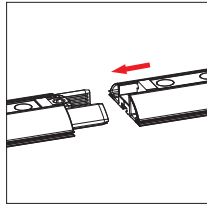

2

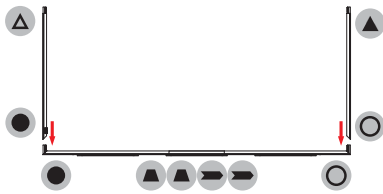
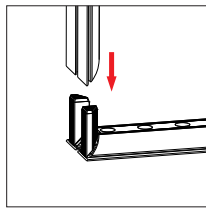

3

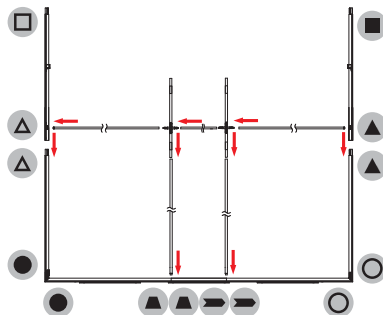
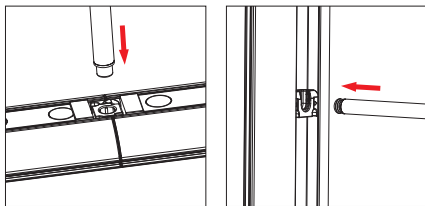

4

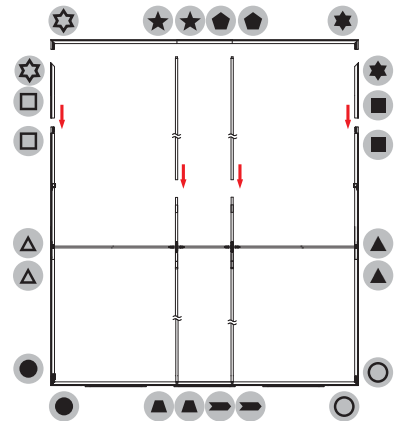
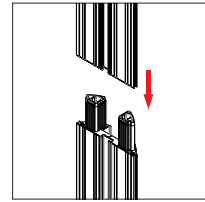

5

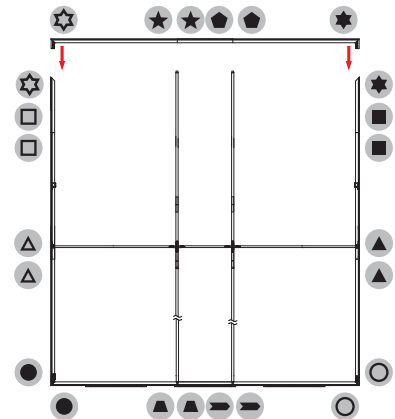
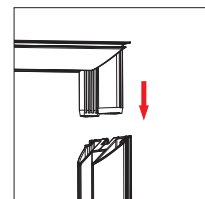

# FabLite BrightLine Panel P

FL-BL-PP

- 6 Push the silicone bead into each corner of the frame with your thumb.

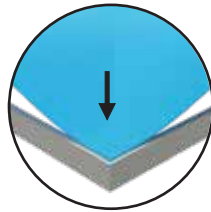
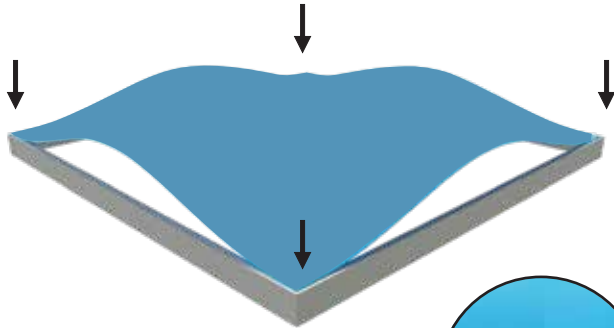

Push the silicone bead into the middle of the run and work your way around the perimeter of the frame until all beading is pushed in properly

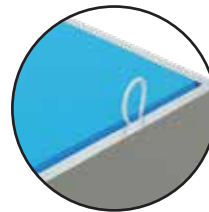
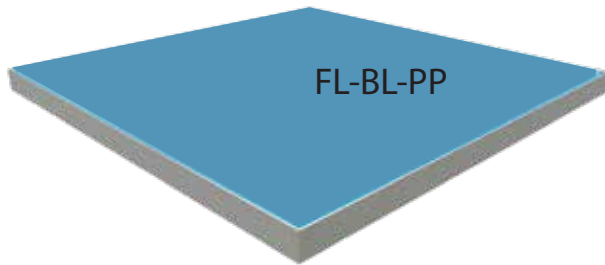
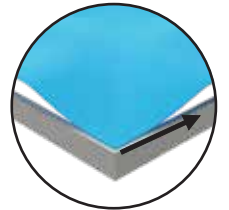
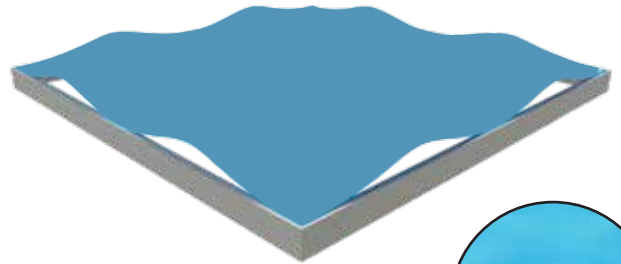

**To Remove Graphic**  
Use the pull tab located on the graphic and gently pull the graphic from the frame, going around the perimeter

- 7

