

FabLite Backlit - FL-BL-8-02

FabLite Backlit fabric light boxes feature durable 100mm aluminum extrusion frames, push-fit back-lit fabric graphics and LED top and bottom lighting. Single and double-sided graphic options are available. LED lights come adhered to the frame, making set-up as simple as assembling the frame, applying the push-fit graphics and plugging in the electrical cord!



features and benefits:

- 100mm (4") silver extrusion frame
- LED lighting top & bottom
- Single or double-sided push-fit fabric graphics
- Easy assembly
- Comes packaged with one wheeled molded case for transport and storage
- Lifetime hardware warranty against manufacturer defects

dimensions:

Hardware

Graphic

Assembled unit:
95.35" w x 94.74" h x 19.7" d
2422mm(w) x 2407mm(h) x 500mm(d)

Refer to related graphic template for more information.

Approximate weight with case:
89 lbs / 41 kgs

Shipping

additional information:

Packing case(s):
1 OCH

Graphic material:
Backlit Intensity push-fit fabric graphic

Shipping dimensions:
50" l x 29" h x 12" d
1270mm(l) x 737mm(h) x 305mm(d)

When included in a larger kit, a different packaging solution will be listed to accommodate all contents of the kit. Individual packaging no longer provided.

Approximate total shipping weight (includes cases & graphics):
74 lbs / 42 kgs



This product may include the following materials for recycle:
aluminum, select wood, fabric, cardboard, paper, steel, and plastics.

1 person assembly recommended:



*Not to scale

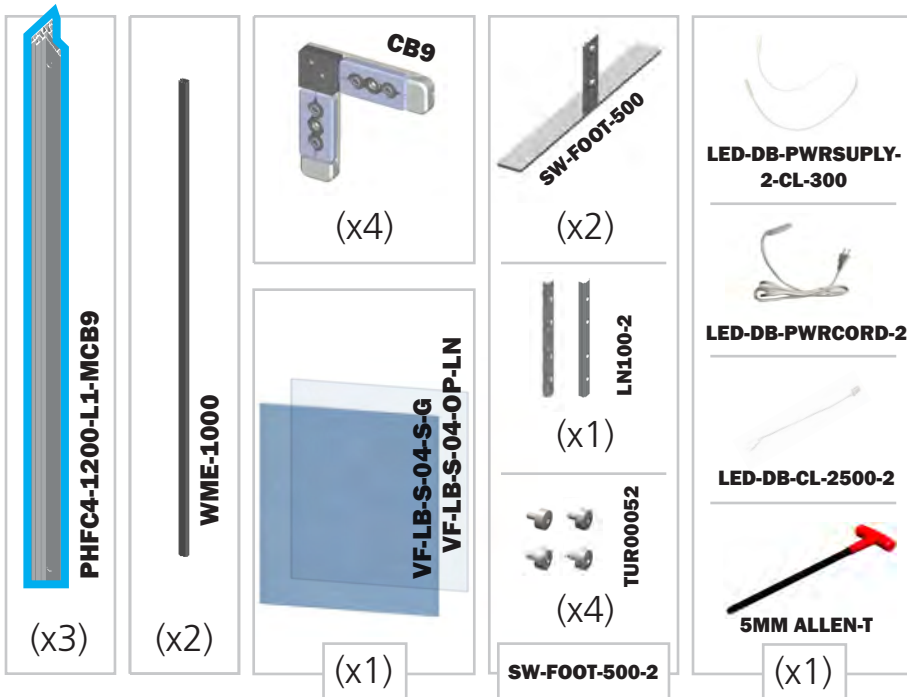
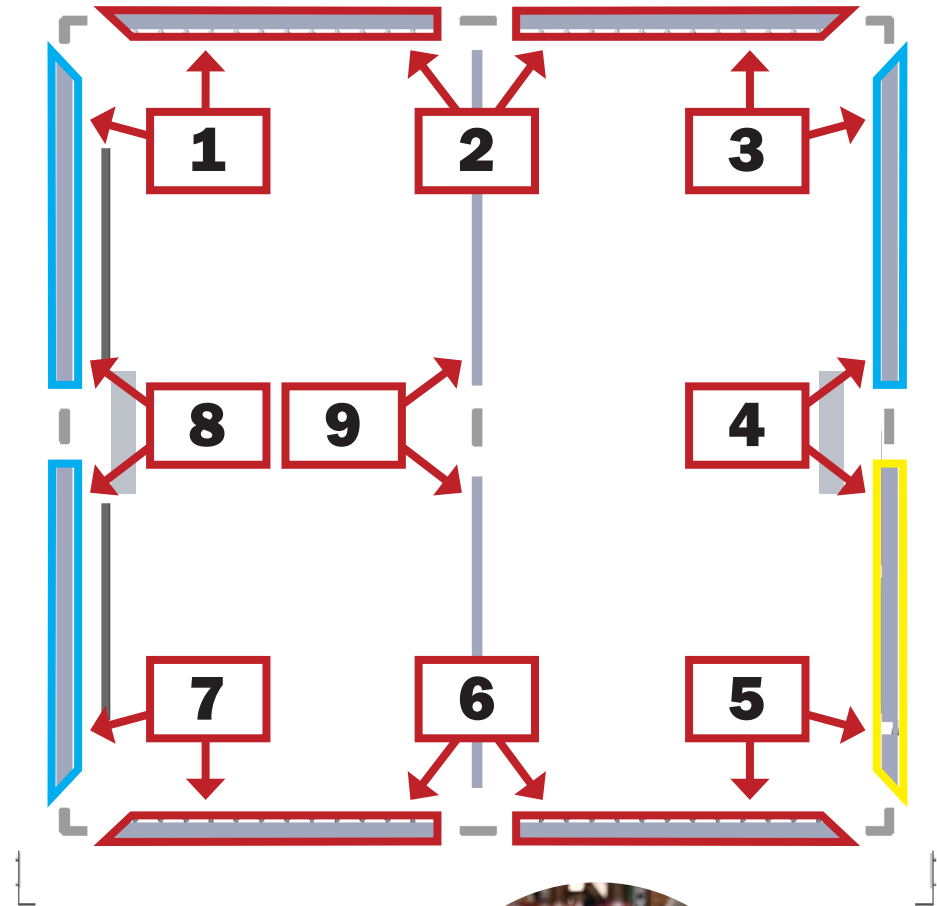
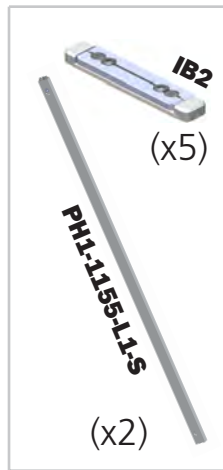
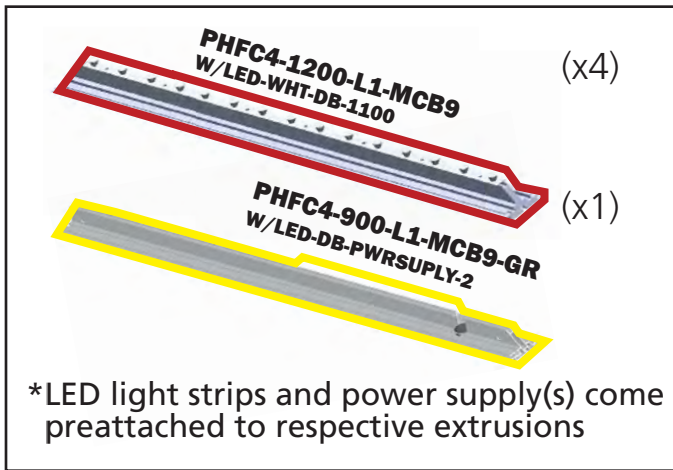

*Not reflective of final connection

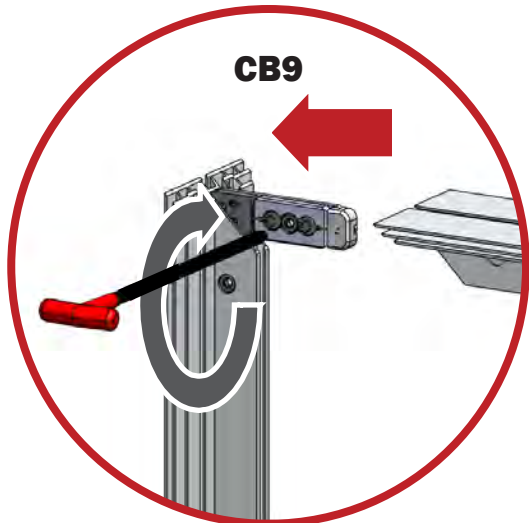

CB9

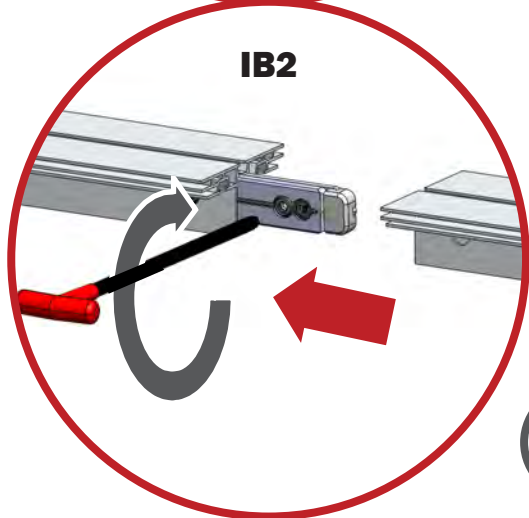

IB2

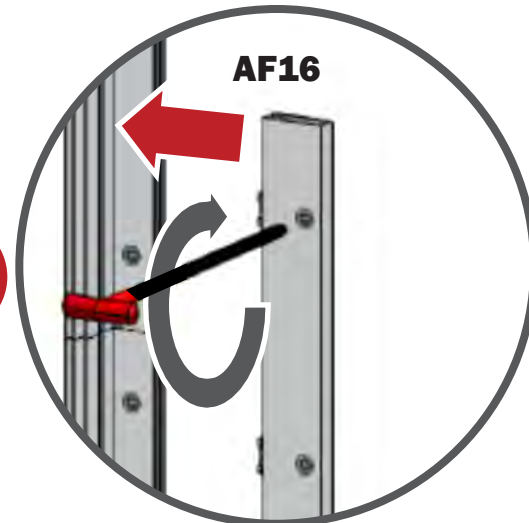

AF16

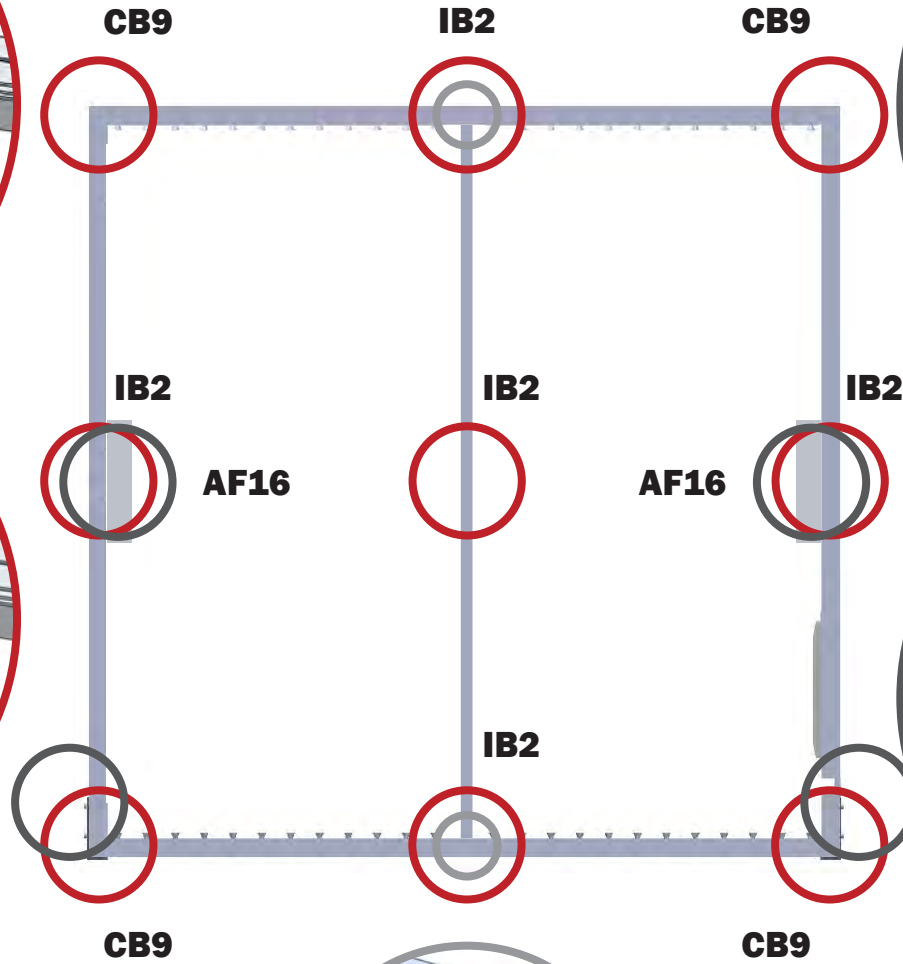
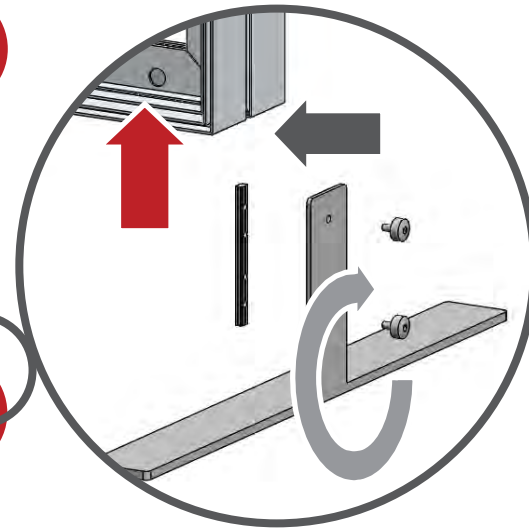

*CB9 & IB2 connection are consistent

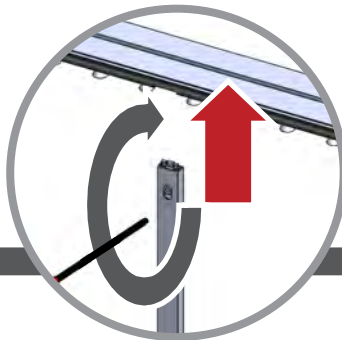

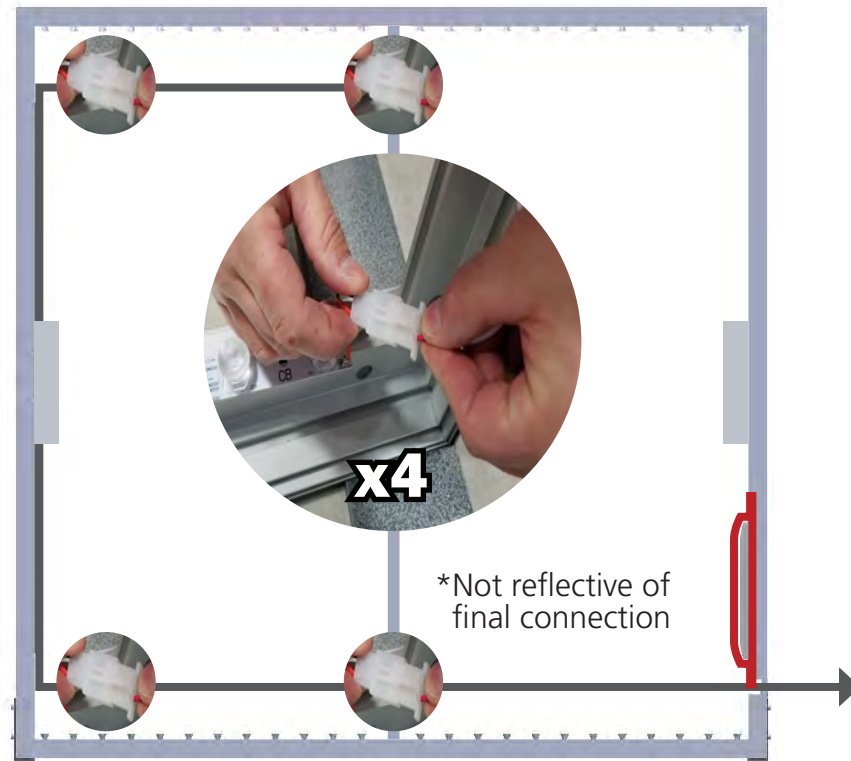
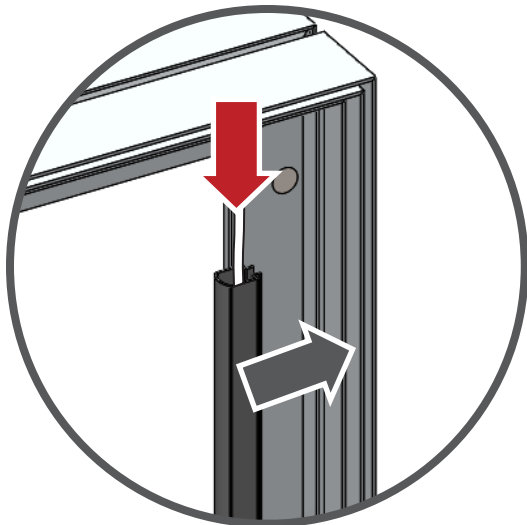



Fit graphic into corners,
then "tap" into rest
of frame channel.

"Sliding down" graphic
is not recommended
for best installation.

Repeat for backer.

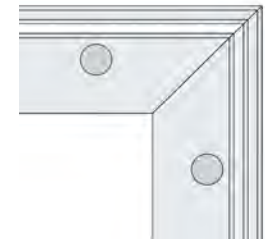
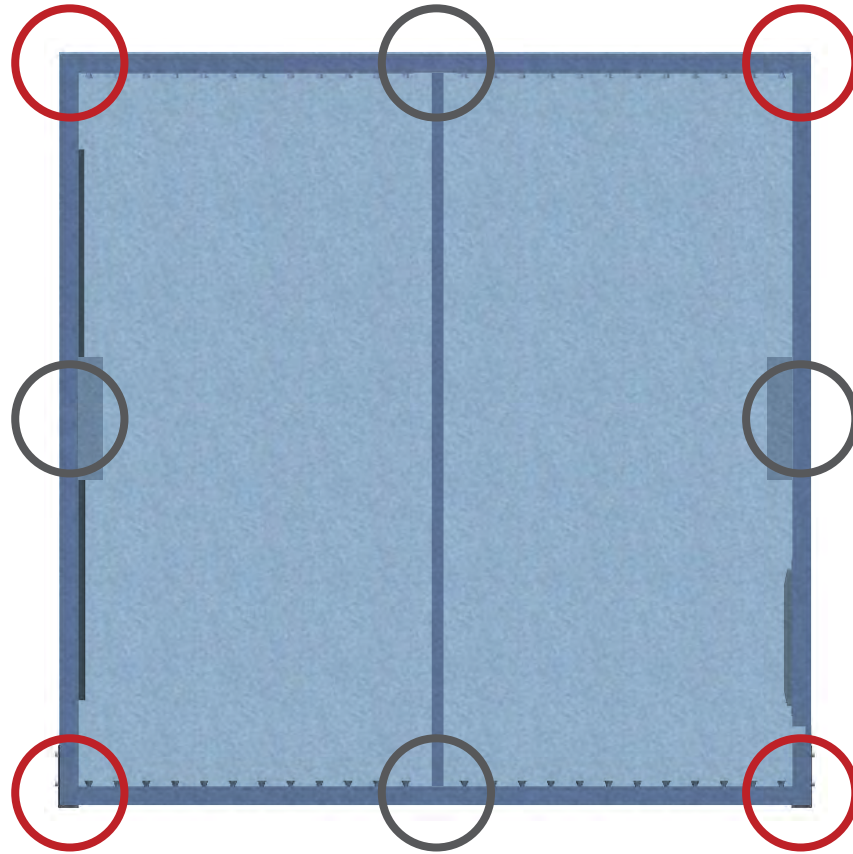

Backer
2nd channel

Graphic
1st channel

