

FabLite Designer Series 10' Kit 03 - FL10-D03

FL10-DS03

Fablite Designer Series 10ft displays have unique stylistic features and shapes, are portable and easy to assemble. The aluminum tube frame features snap-buttons and/ or spigot connections and zipper pillowcase fabric graphics. All displays come in portable, wheeled transit cases. Simply pull the pillowcase fabric graphic(s) over the frame and zip.



features and benefits:

- Premium aluminum tube frames with pigot assembly
- Easy to store and ship
- Quick to set up
- Weighted feet for added stability
- Two zipper pillowcase fabric graphics
- Lifetime limited hardware warranty against manufacturer defects

dimensions:

Hardware

Assembled unit:
120"w x 96"h x 17.7"d
3048mm(w) x 2438mm(h) x 450mm(d)

Approximate weight with cases:
56 lbs / 25.4 kgs

Graphic

Refer to related graphic template for more information.

Visit:
www.exhibitors-handbook.com/graphic-templates

Shipping

Packing case(s):
1 OCE Case

Shipping dimensions:
OCE: Expandable case length (l) may vary
40" - 66"l x 18"h x 18"d
1016mm-1677mm(l) x 458mm(h) x 458mm(d)

Approximate total shipping weight
(includes cases & graphics):
71 lbs / 32.2 kgs

additional information:

Graphic material:
dye-sublimation zipper pillowcase fabric

When included in a larger kit, a different packaging solution will be listed to accommodate all contents of the kit. Individual packaging no longer provided.

We are continually improving and modifying our product range and reserve the right to vary the specifications without prior notice. All dimensions and weights quoted are approximate and we accept no responsibility for variance. E&OE. See Graphic Templates for graphic bleed specifications.

Included In Your Kit

Tools, Components, & Connectors



ALLEN KEY SET x1



ES30 x8



TCP-3030-R x1



ES30-90B x4



PLT-BP-LN114-S2-450 x2

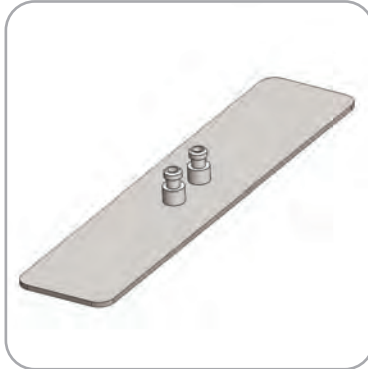

PLT-BP-LN114-S3-450 x1

Graphics



FMLT-DS-10-03-A-G x1



FMLT-DS-10-03-B-G x1

Included In Your Kit



DS-10-03-T1 x1



DS-10-03-T2 x3



DS-10-03-T3 x1



DS-10-03-T4 x1



DS-10-03-T5 x1

Tubes



DS-10-03-T7 x1



DS-10-03-T8 x3



DS-10-03-T10 x1



DS-10-03-T11 x1



DS-10-03-T12 x1

Labeling Diagram

FL10-DS03

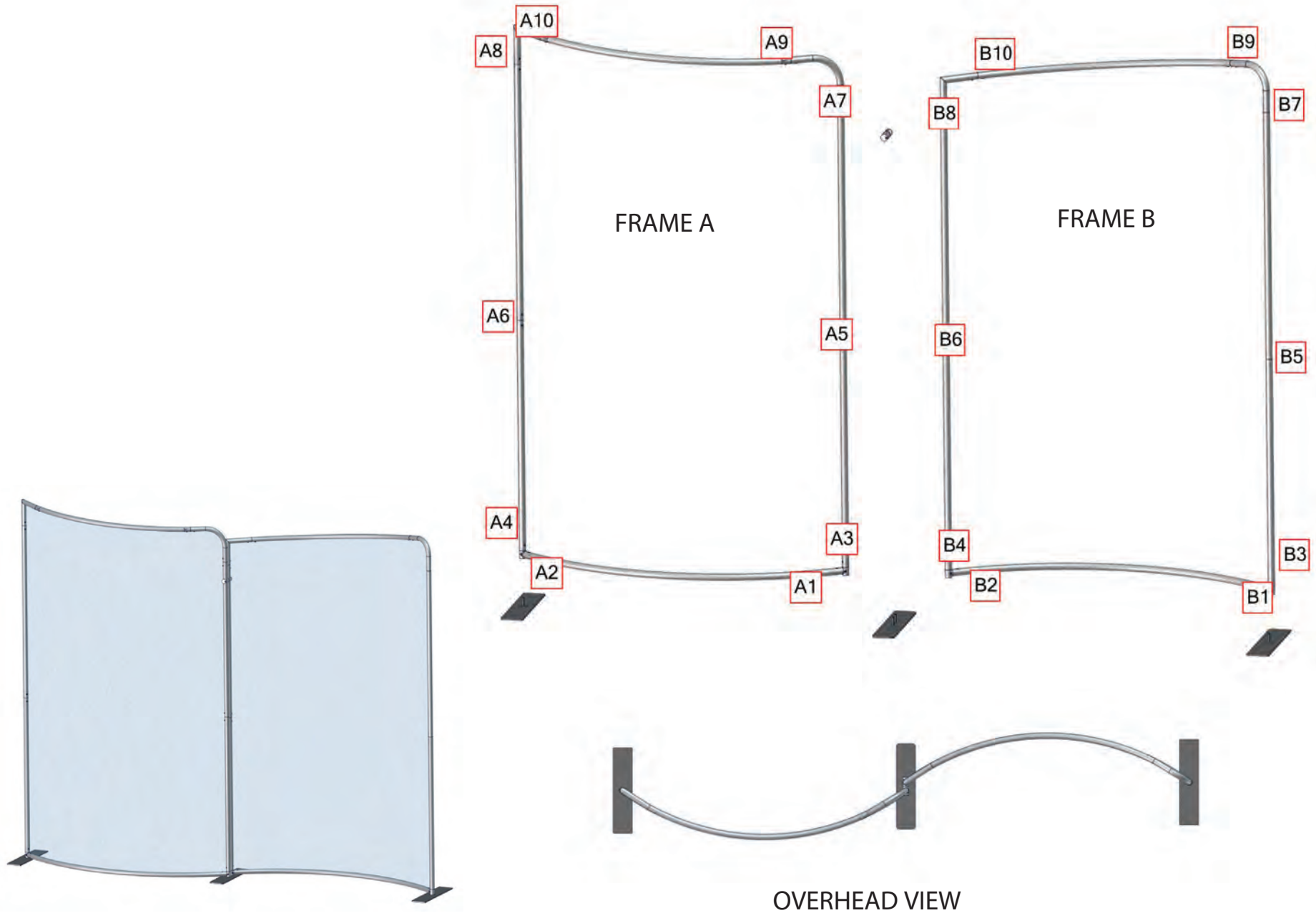

Connection Methods

Fablite structures use a number of different yet simple connection methods. Your kit will include one or more of the connection methods shown below. Steps within the Kit Assembly will reference a specific method for each connection point.

Connection Method 1: ES30 / ES50 / ES75

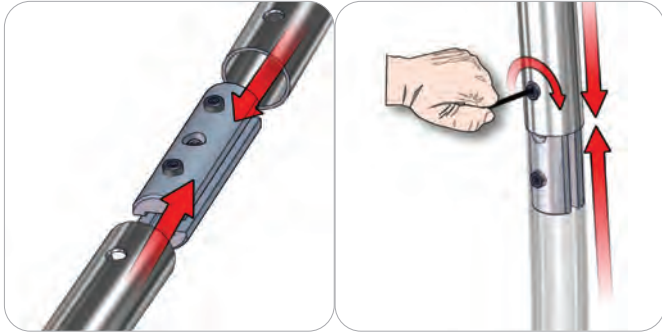

Compress the unlocked connector and slide one tube onto each end. Lock both screws carefully using your allen key tool. Be sure to lock securely, but do not overtighten.

Connection Method 2: Snap Buttons & Swage

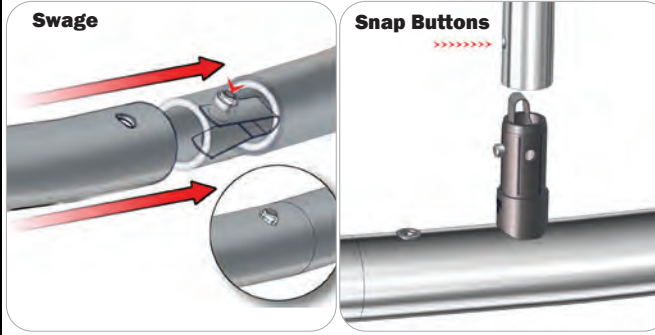

Locate the snap button on the connector or swage tube. Locate the hole on the corresponding tube. Press the snap button with your thumb and slide the tube and connector together so that the snap button snaps fully into the lock hole. To disassemble, press the snap button and pull apart.

Connection Method 3: ES30-90B / ES30-I / ES30-C

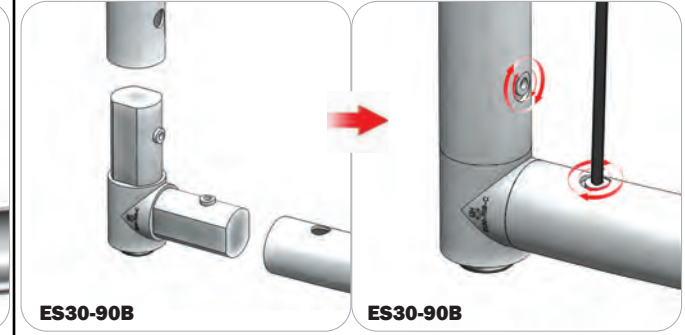

Compress one unlocked end of the connector and slide it through one tube end. Compress the other end of the connector and slide the second tube on. Lock both screws carefully using your allen key tool. Be sure to lock securely, but do not overtighten.

Connection Method 4: Tube Clamps

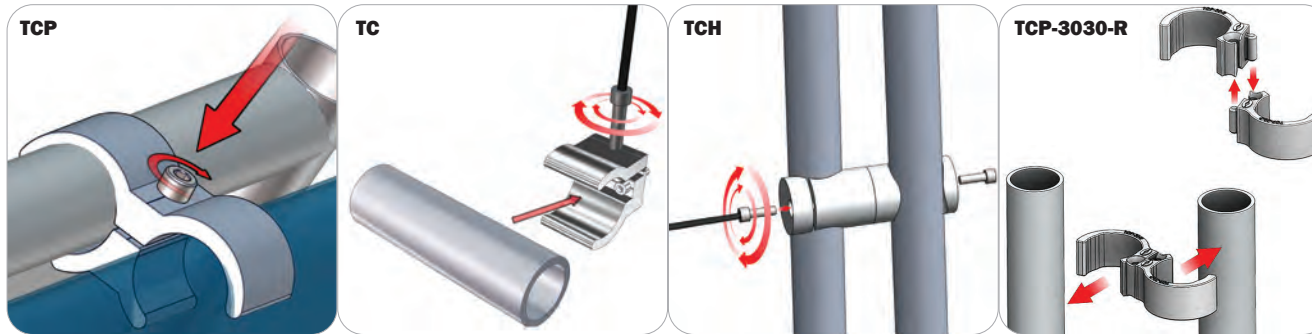

Be sure to fully assemble all frames before using clamps. With the clamp unlocked, place one tube of the first frame into the mouth of the clamp. Place the second tube (if applicable) into the second mouth of the clamp. With both frame's tubes in the clamp, be sure to lock securely, but do not overtighten.

Kit Assembly

Step by Step

Step 1.

Gather the components necessary to assemble Frame A. Assemble your frame following the order specified in the Labeling Diagram.

Please reference Connection Methods 1, 2 and 3 for more details.

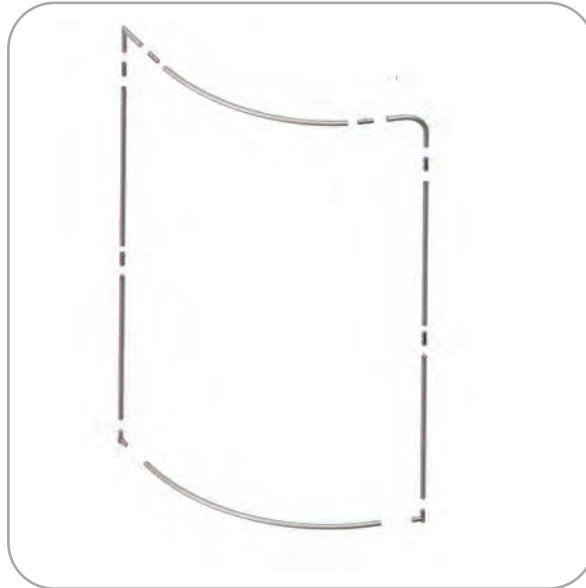

Step 2.

Gather the components necessary to build Frame B. Assemble your frame following the order specified in the Labeling Diagram.

Please reference Connection Methods 1, 2 and 3 for more details.



Step 3.

Locate the fabric cover for Frame A. With the frame flat on the floor, pull the cover over the top of the frame. Zip the fabric cover to enclose the frame.

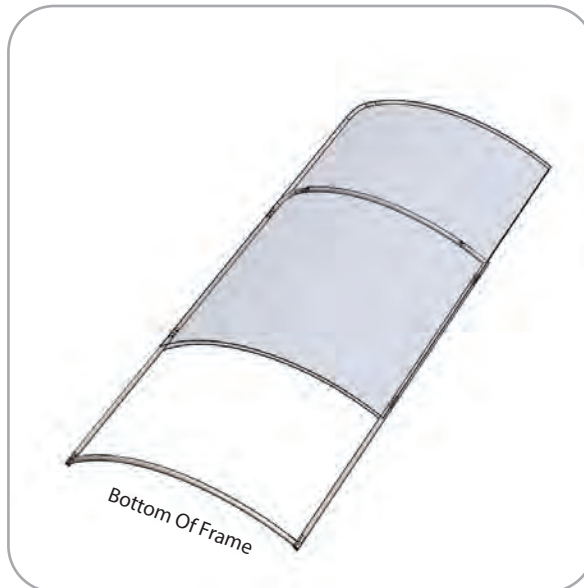

Step 4.

Locate the fabric cover for Frame B. With the frame flat on the floor, pull the cover over the top of the frame. Zip the fabric cover to enclose the frame.

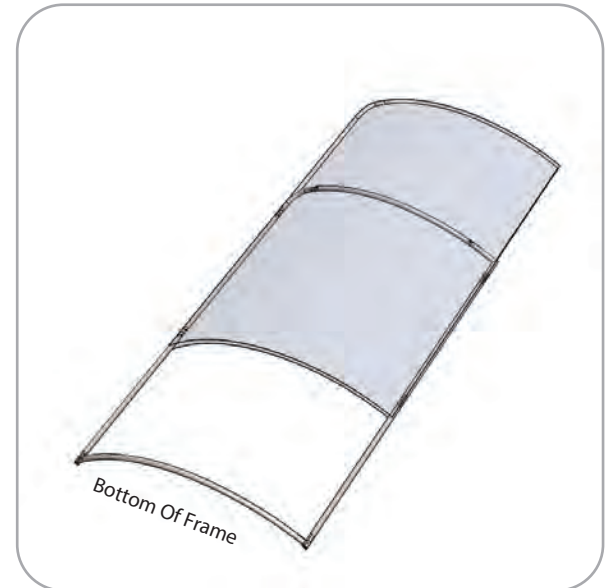

Kit Assembly

Step by Step

Step 5.

Locate the stabilizing bases LN114-S2-450. Attach the base to the bottom of the ES30-90B on the left side of Frame A and the right side of Frame B. Tighten the screw on the side of the ES30-90B to lock it in place.



Step 6.

Locate the stabilizing base LN114-S3. Attach the base to the bottom of the ES30-90B on the right side of Frame A and the left side of Frame B. Tighten the screw on the sides of the ES30-90Bs to lock them in place.

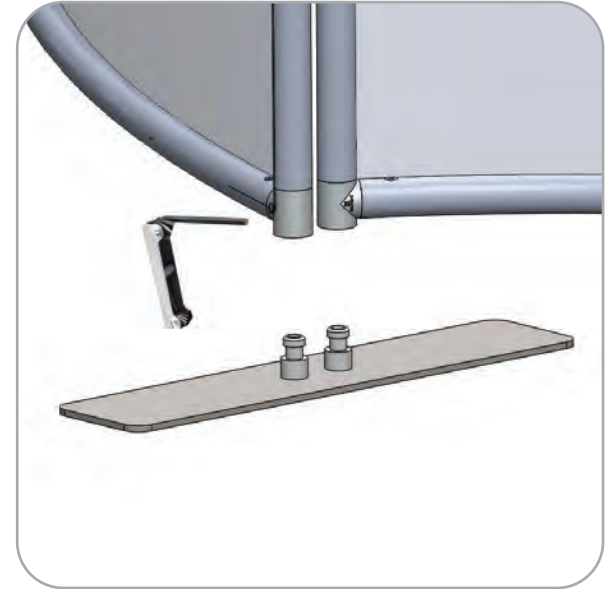

Step 7.

Use the TCP-3030-R connector to brace both frames together at the top insides of both frames.

Please reference Connection Method 4 for more details.

