



Steps to Assemble the InfiniLite Shelving Display:

- Step 1:** Assemble the Short Pillars.
- Step 2:** Place Short Pillars upright in their proper order.
- Step 3:** Attach Short Wall Panel to Pillars.
- Step 4:** Install Shelf Support Bars.
- Step 5:** Attach Shelves to Shelf Support Bars with Velcro.

Assemble Short Pillars.

A) Unfold the Short Pillar Panels with the front sides facing downward.

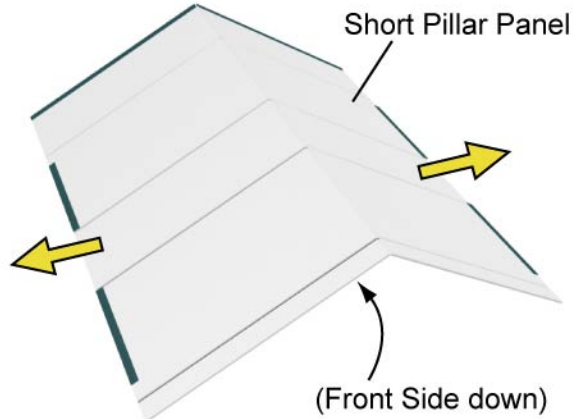

B) Attach Top and Bottom Supports to the back of the Short Pillars with Velcro.

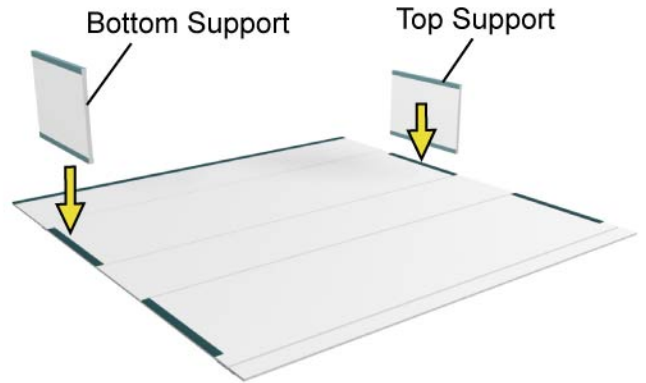

C) Fold Short Pillar around the Top and Bottom Supports and attach with Velcro.

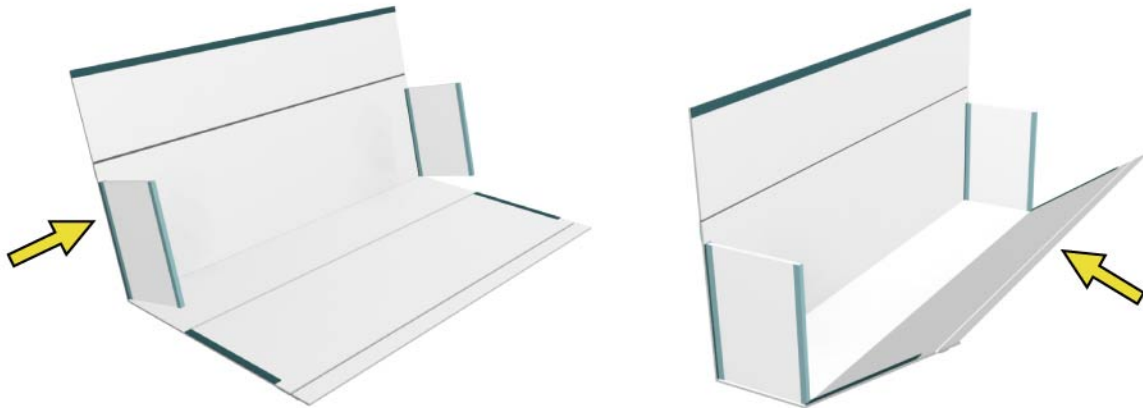

D) Close the Short Pillar using the Velcro strips along the edges.

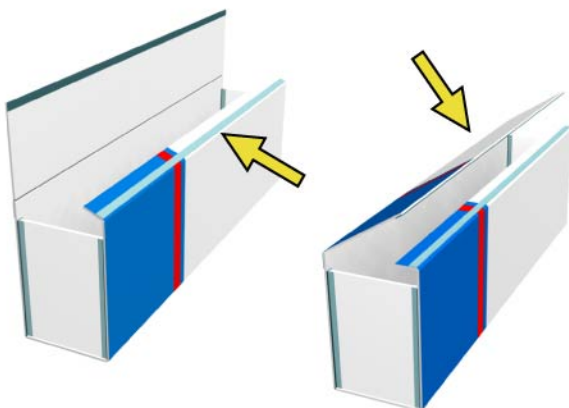

E) Attach Pillar Top to the Short Pillar with Velcro.

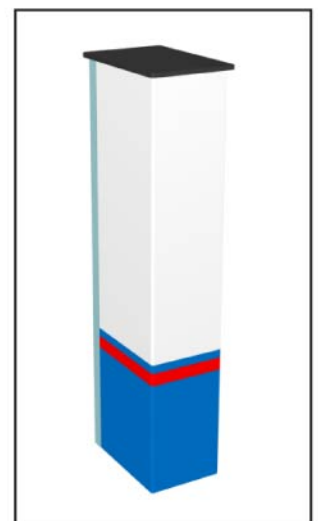

Assembled Short Pillar

Assembly Instructions:

InfiniLite Shelving Display

Place Short Pillars upright in their proper order.

A) The following Floor Plan identifies the locations of the Short Pillars and Wall Panel.

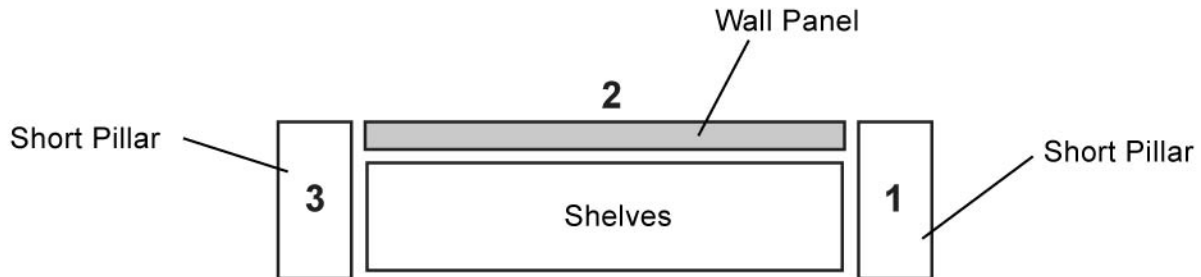

TOP VIEW

B) Place the assembled Pillars in their locations as numbered and indicated on the Floor Plan.

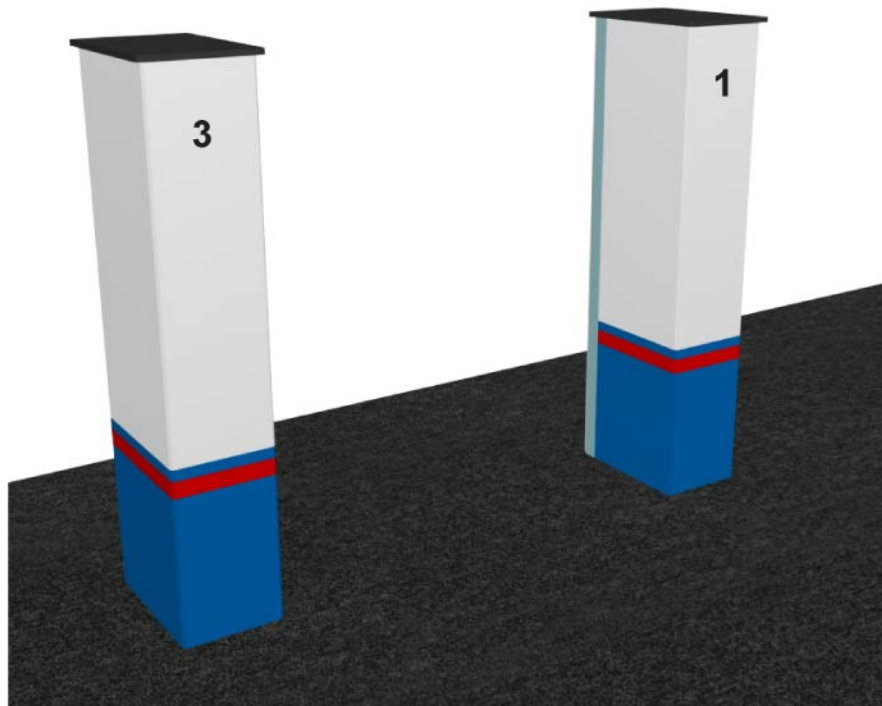

Attach Short Wall Panel to Pillars.

A) Unfold the Short Wall Panel, hold upright, and attach to Pillar with Velcro. (Make sure that the bottoms of the Pillar and Short Wall Panel are flat against the floor when attaching and that the accent stripes are aligned with each other.)

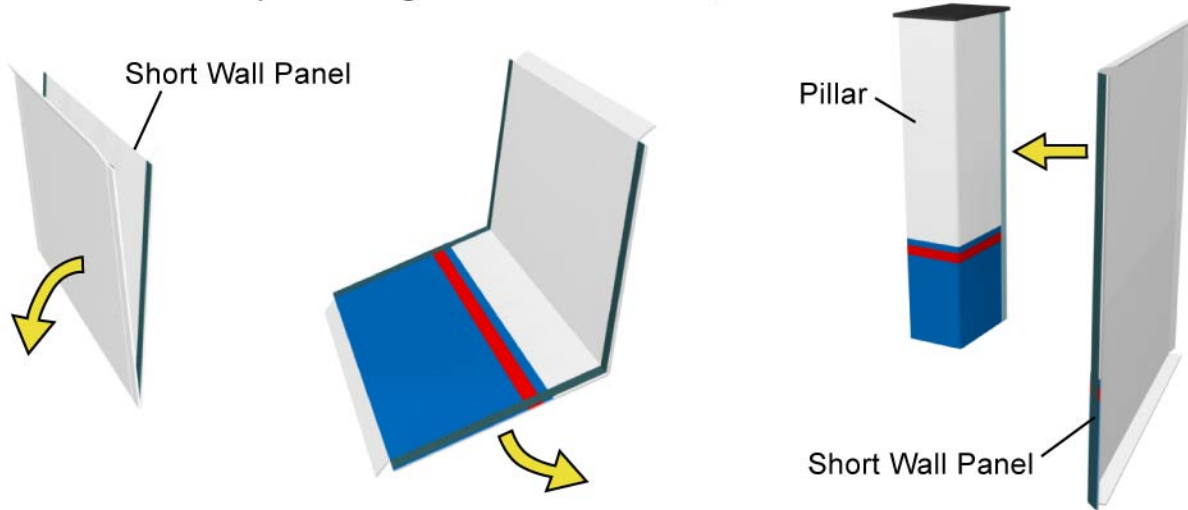

B) Rotate the Short Wall Panel into position. Attach the Short Pillar to the Short Wall Panel so that it is flat against the front face of the Short Wall Panel. Rotate the Pillar into position.

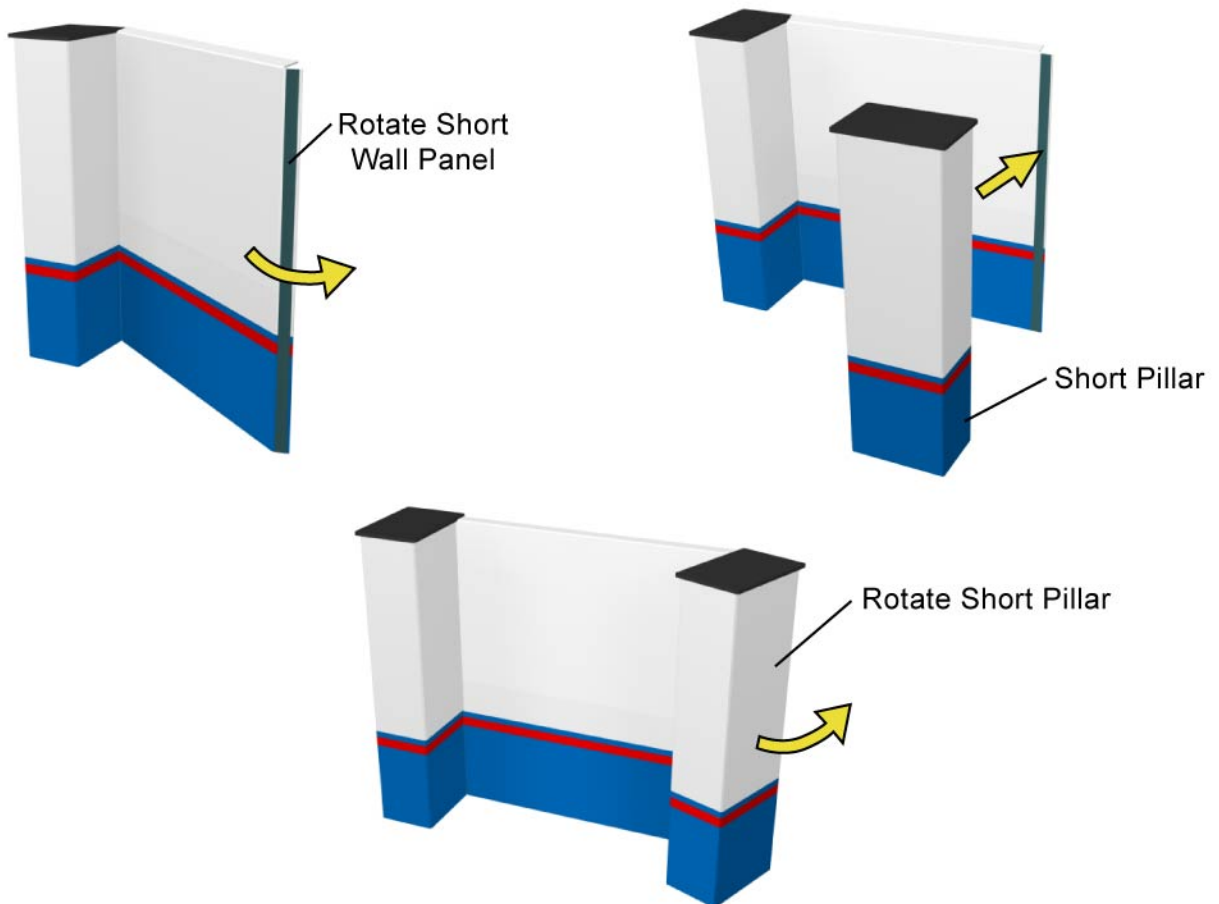

Install Shelf Support Bars.

A) Insert the square support bars into their designated openings in the Pillars with the **back bars** first, installing from the bottom upward. Then install the **front bars** from the bottom upward.

Make sure that the **Velcro on the bars is facing up** to attach the shelves and that the full portion of the **vinyl covering is facing forward** (if vinyl has been applied to the front of the support bar).

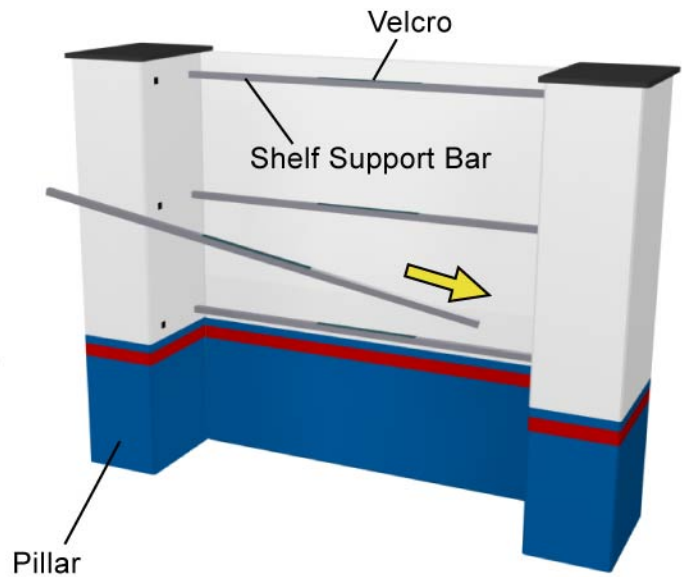

Attach Shelves to Shelf Support Bars with Velcro.

A) Place the Shelves on top of the Shelf Support Bars and attach with Velcro.

